

SKILL LEVEL

one size fits all!



ADVANCED  
BEGINNER

*www.hotpatterns.com*<sup>tm</sup>  
patterns so hot they're smokin'...

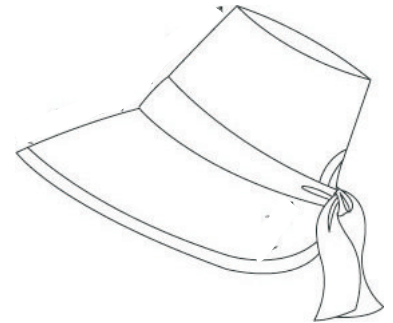

HotPatterns & fabric.com exclusive download  
Sunny Side Up Sunhat

Protect your gorgeous face and precious skin from the sun this Summer with our fabulously flattering sunhat! This is designed for fabrics with a little body, like denim, drill, canvas or home-dec materials, but you can also use lighter weight fabrics with a canvas interlining.

Chic bucket-style hat has an oval crown, high tapered sides and a shaped brim with a center back, baseball-cap style cut-out. Contrast binding finishes the brim edge and a contrast band and tie means you can adjust the hat to fit you perfectly.

# Hot Patterns & fabric.com

## exclusive free download sunny side up sunhat instructions page 1 of 2

### SEAM ALLOWANCES & OTHER INFO

Seam allowances are 5/8" or 1.5 cm wide;  
all seams are sewn right sides together  
unless otherwise stated.

The edge of the brim on the sunhat are finished  
with self fabric OR contrast bias binding; the hat size  
is adjusted by tightening the ties at the crown.

Skills needed include: making & applying bias binding;  
making & applying a tie; joining fabric along curved edges.

### ABOUT THIS STYLE

This sunhat has a soft, slightly relaxed silhouette.

We haven't included a pattern for the bias binding...  
you just need to cut enough strips of 1 1/2" or 3.75 cm  
wide fabric to go around the outer edge of the brim.

Don't bother to make a muslin for this one, but do  
pin all the pattern pieces together first and try it on,  
so you can check it for dimensions and construction.

SUGGESTED CUTTING LAYOUT  
FOR THE FABRIC & CANVAS LAYERS  
fold fabric/canvas in half, with selvedge  
to selvedge for this layout

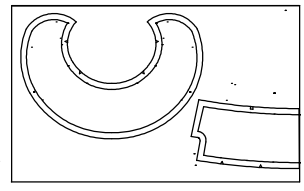

SUGGESTED CUTTING LAYOUT  
FOR THE LINING  
fold lining in half, with selvages  
to the center for this layout

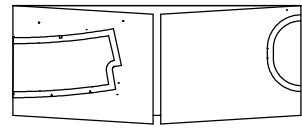

SUGGESTED CUTTING LAYOUT  
FOR THE CONTRAST HAT BAND/TIE  
fold contrast in half, with selvedge  
to selvedge for this layout

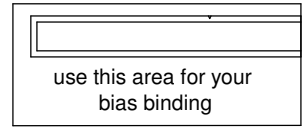

### FABRIC & NOTIONS REQUIRED

You'll need around 5/8 yard/ 50 cm of fabric & canvas for the hat.  
You'll also need around 3/8 yard/ 33 cm of lining, plus 3/8 yard/ 33 cm  
contrast fabric for the hat band/tie & bias binding

5/8 yards / 50 cm interfacing is optional.

All fabric requirements are for 60" / 150 cm wide fabric.

**1a** Start by preparing the bias binding.  
Join the short ends of each piece to make a long strip.

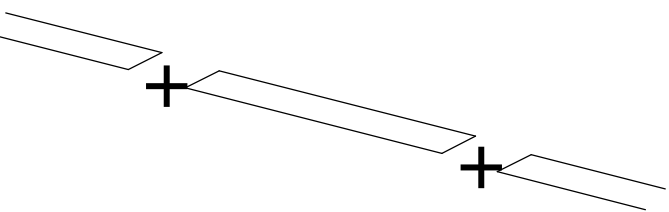

**1b** Press the seams open, then feed your bias strips  
through a bias binding folder, pressing as you go.  
Set aside until step X.

**2** If you are using interfacing, apply it to your fabric now.

If you are interlining your hat with canvas, baste the  
canvas pieces to the back or wrong side of the fabric pieces.

If you *\*really\** want a firm hat, you can always interface the  
canvas pieces before you baste them to the fabric pieces...  
but please bear in mind you'll end up with a very VERY stiff hat...

**3** Hem the hat band/tie from notch to notch...

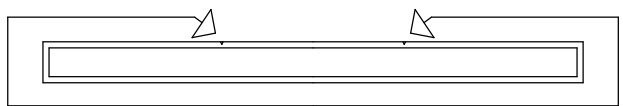

...use a 5/8" or 1.5cm turning. Press flat, and set aside until step X.

# instructions page 2 of 2

- 4a WRONG SIDES TOGETHER, baste together the crown & crown lining pieces, along the outer edges.

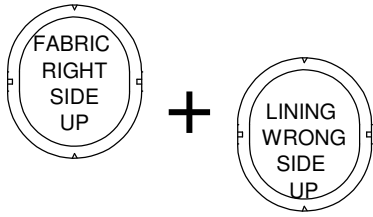

- 4b WRONG SIDES TOGETHER, baste together the brim pieces, along the outer edges.

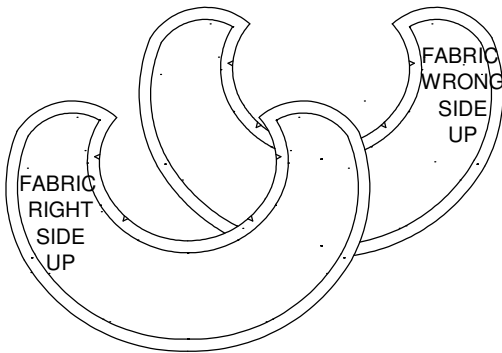

- 5 Join the sides along the center back seam.  
Join the side lining along the center back seam.

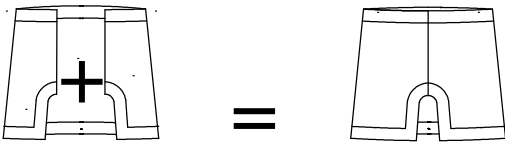

Press all seams open.

- 6 Sandwich together the crown, side and side lining.

Sewing through all thicknesses, join the side & side lining to the crown. Press the seam open, clip the seam allowance and turn out.

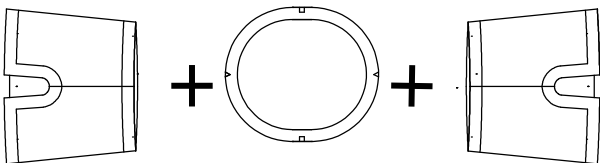

- 7 Baste together the side layers along the center back opening.

- 8 With the seam allowances facing out (they'll be covered by the hat band/tie), join the brim to the hat side/crown assembly. Press the seam open, then press the seam allowances upwards towards the crown, and notch or trim back the seam allowances.

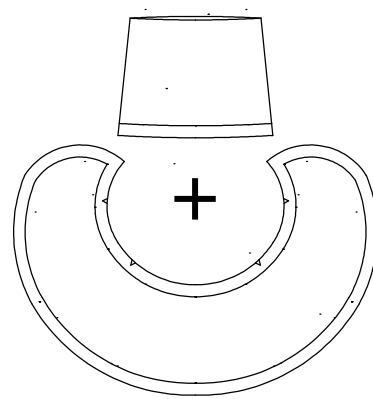

- 9 Apply the bias binding to the brim & back opening edges: working on the wrong side, sew the binding to the brim & back opening edges along the crease line on the binding.

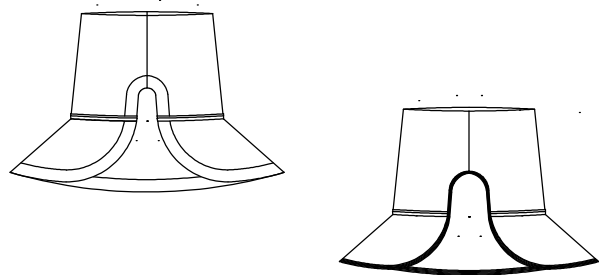

Fold the binding onto the right side of the hat, and sew down the remaining edge. Press flat.

- 10 Apply the tie to the brim seamline...you'll join the un-hemmed part of the hat band/tie to the hat side/brim seamline. You'll start & stop stitching at the bound edges of the back opening.

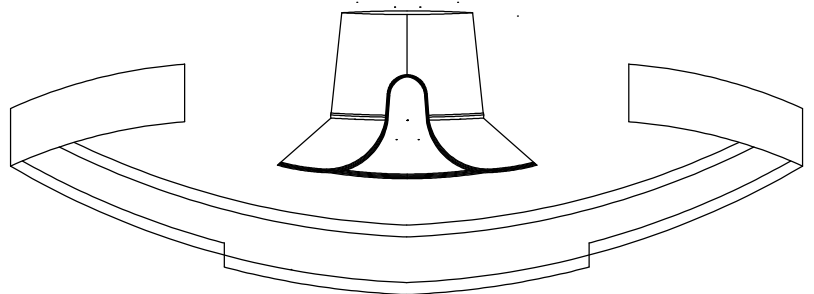

D-O-N-E done!

Now tie on your hat and go out and enjoy the sunshine... don't forget your sunscreen!

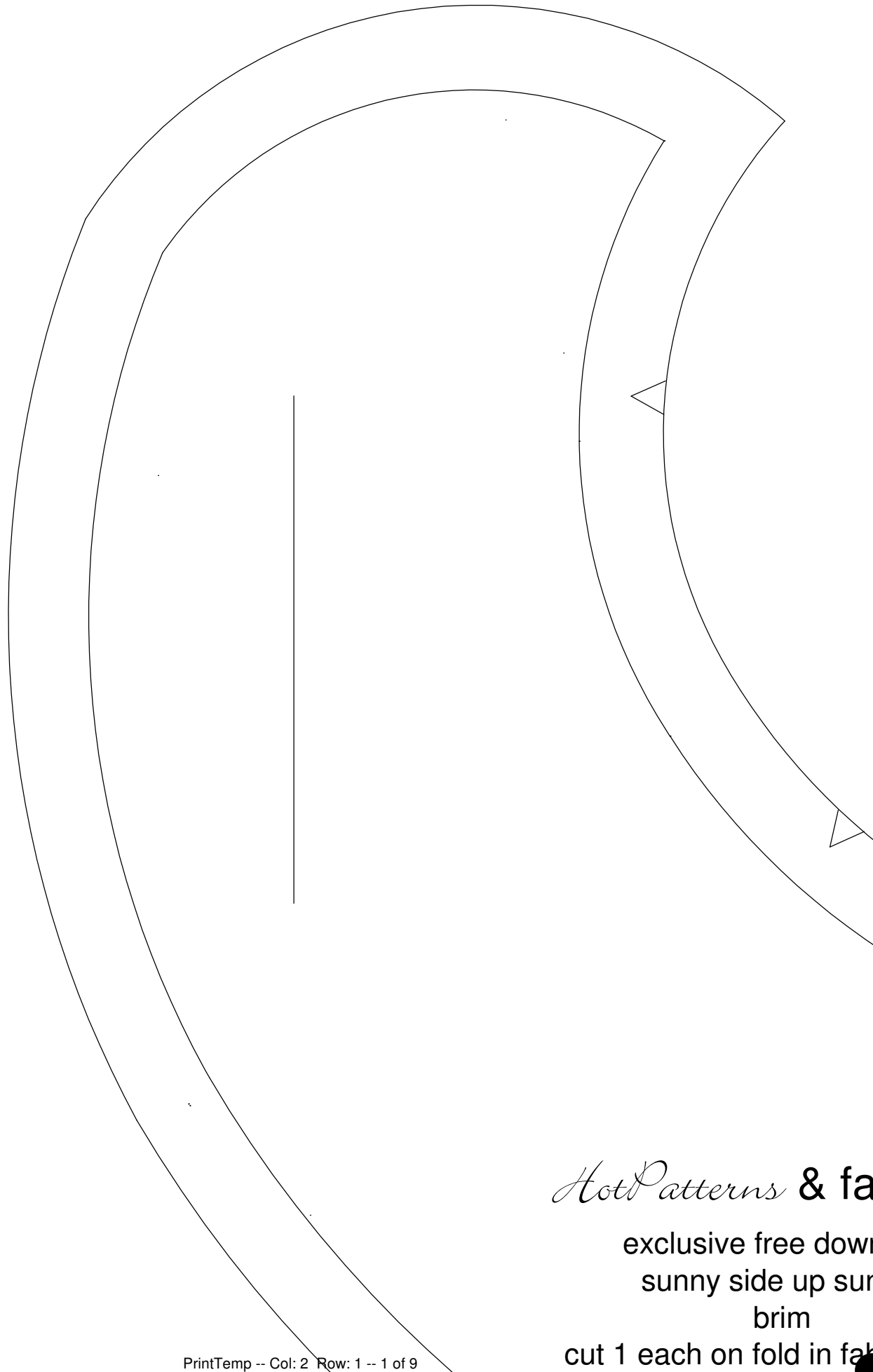

1

*Hot Patterns & fa*

exclusive free down  
sunny side up sun  
brim

cut 1 each on fold in fak



*Hot Patterns &*

exclusive free

sunny side u

side

cut 1 each on fold

and interfacing

2

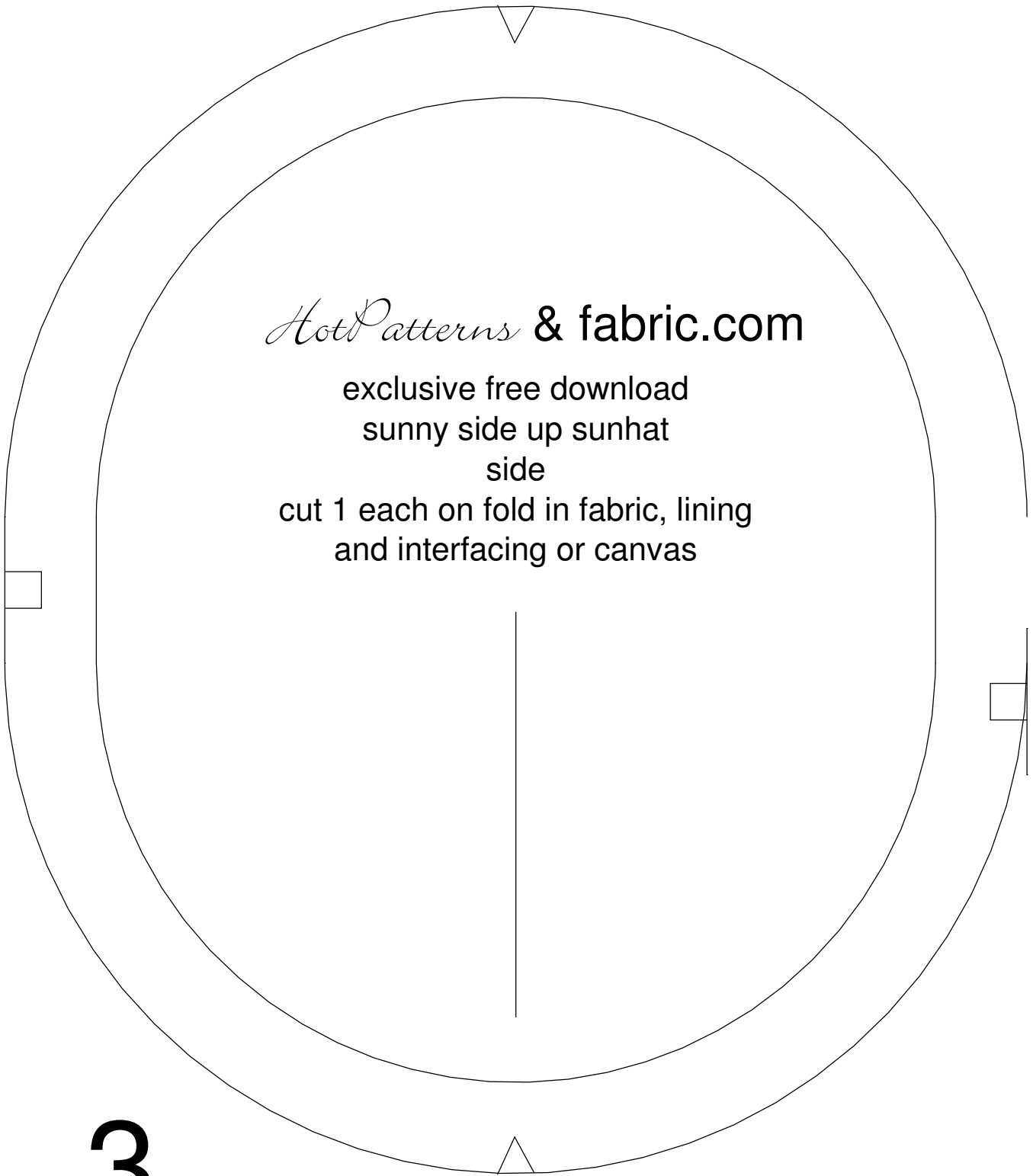

*Hot Patterns* & fabric.com

exclusive free download  
sunny side up sunhat  
side

cut 1 each on fold in fabric, lining  
and interfacing or canvas

3

bric.com

nload  
nhat

eric, lining

OLD

4

anvas

FO

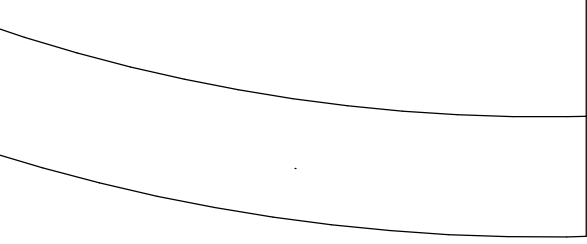

& fabric.com

download  
p sunhat

in fabric, lining  
or canvas

FOLD

5



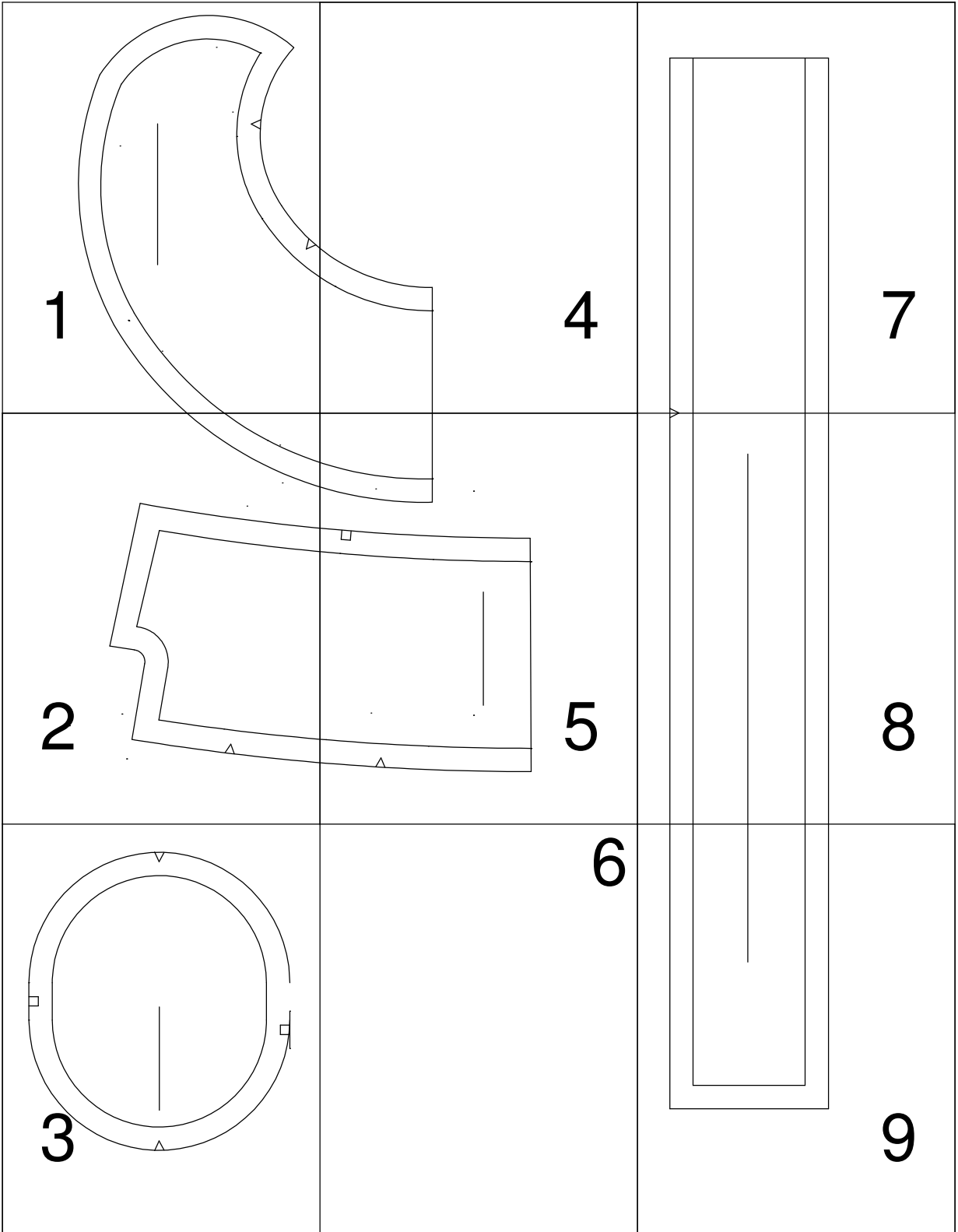

*HotPatterns* & fabric.com

exclusive free download  
sunny side up sunhat  
hatband/tie  
cut 1 on fold in contrast fabric

FOLD

7



8

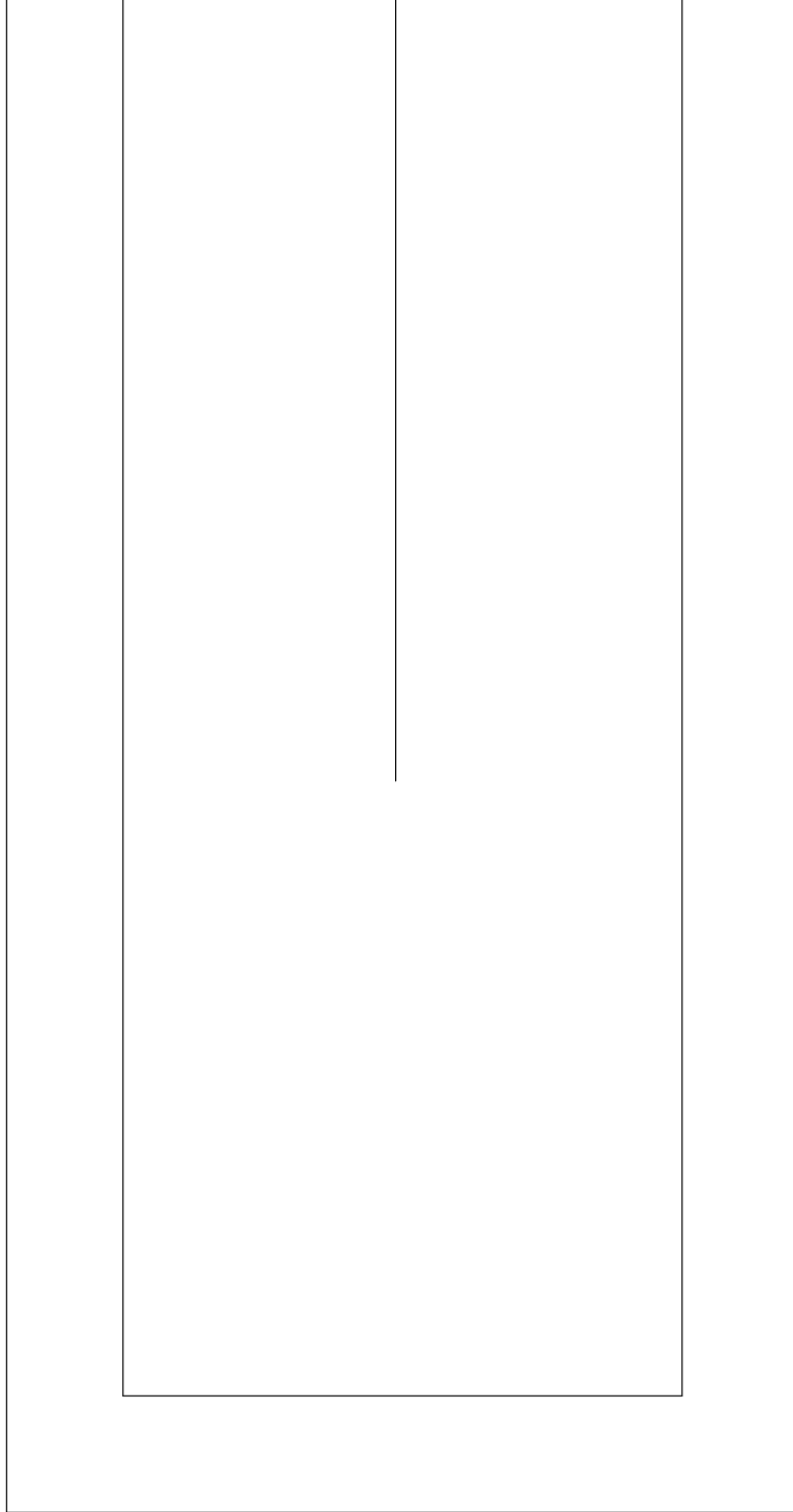

9