

Multi - Use
**COLLAPSIBLE
BASKET PATTERNS**



Over 100 Designs for the Scrollsaw

Rick and Karen Longabaugh













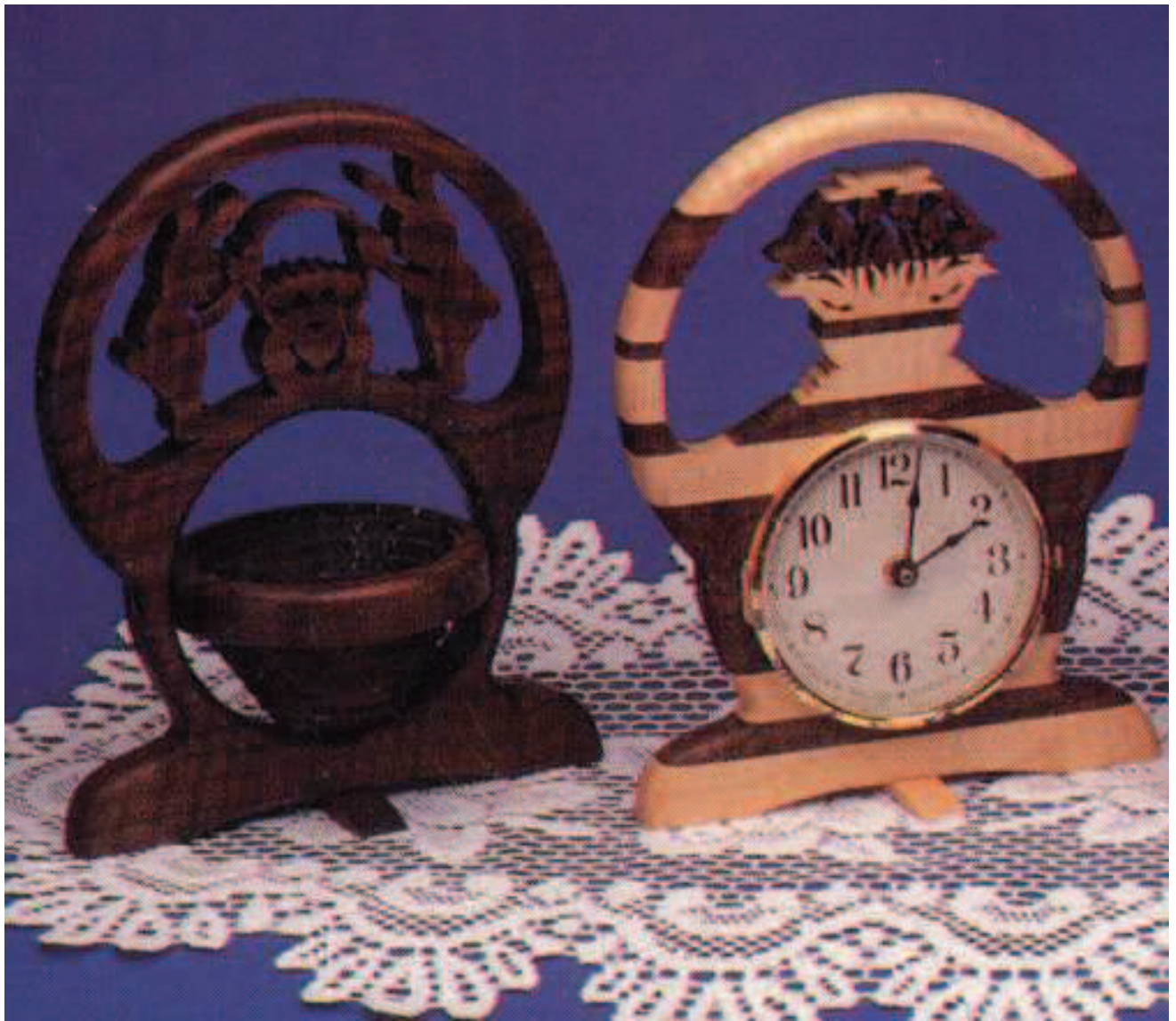













SCROLLSAW PATTERNS:

Following are the full-size scrollsaw patterns for creating beautiful projects from our CD Scrollsaw Pattern Book.

Each pattern is shaded to make it easier to see where to cut and where not to cut.

To navigate from page to page, simply use the vertical scrollbar on the right hand side of the screen, or the “Go To” buttons |◀◀ ▶▶| located at the top and bottom of the screen.

To print, simply click on the “Printer Icon”  at the top of the screen, or choose “Print” from the “File” pull-down menu. Be sure to specify which page numbers you want to print, and the number of copies. You can determine the page number from the “Page #” box | 4 of 107 | at the bottom of the screen.

When finished, click the “First Page” button |◀ to go back to the beginning to choose another section to view.

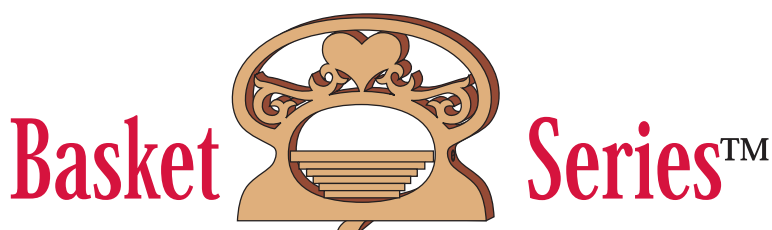

Simply click on the button of your choice.

INTRO

PHOTOS

HOW-TO

PATTERNS

MORE CD'S AVAILABLE

BACK TO START

Circles for Mirrors or Picture Frames

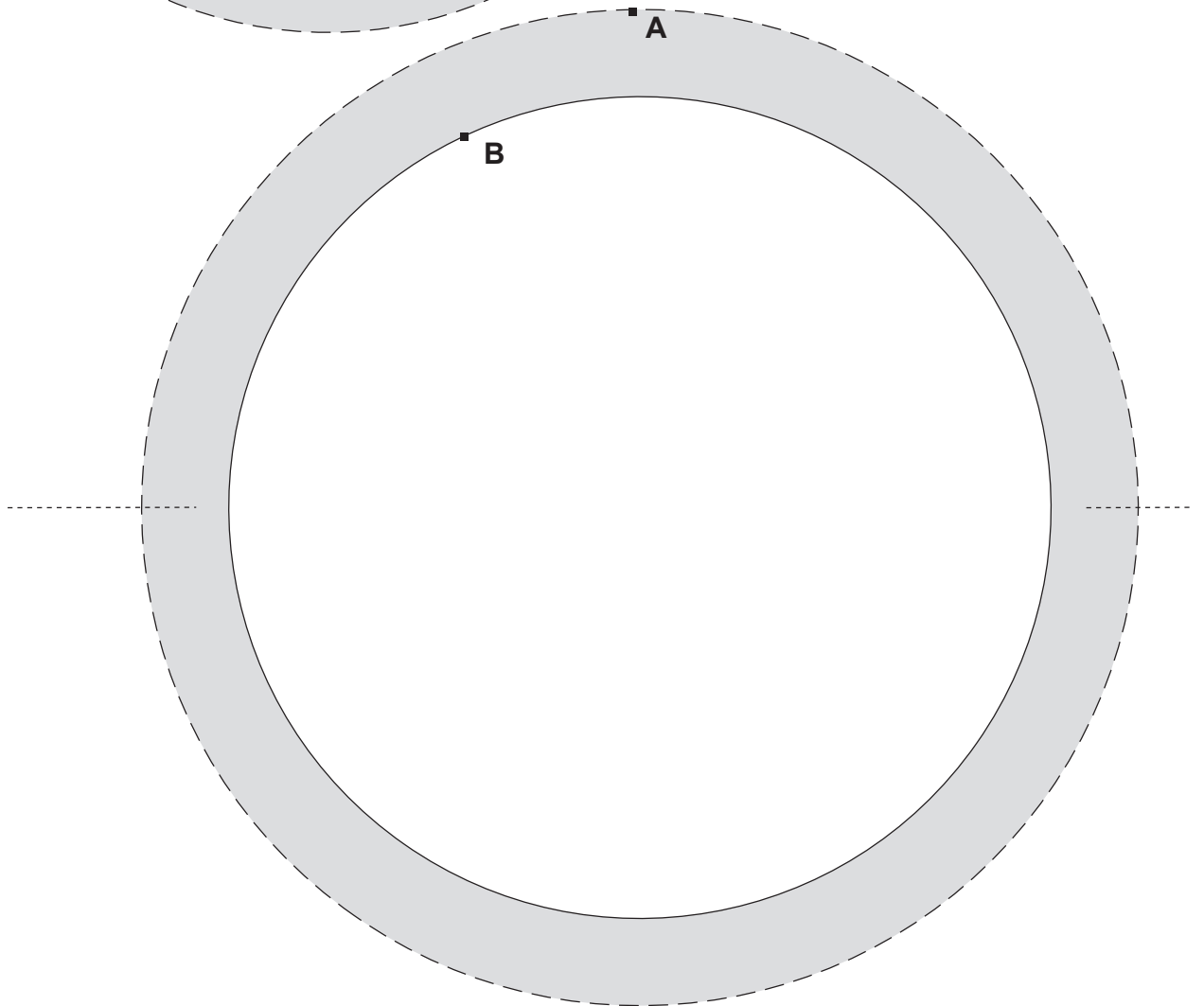
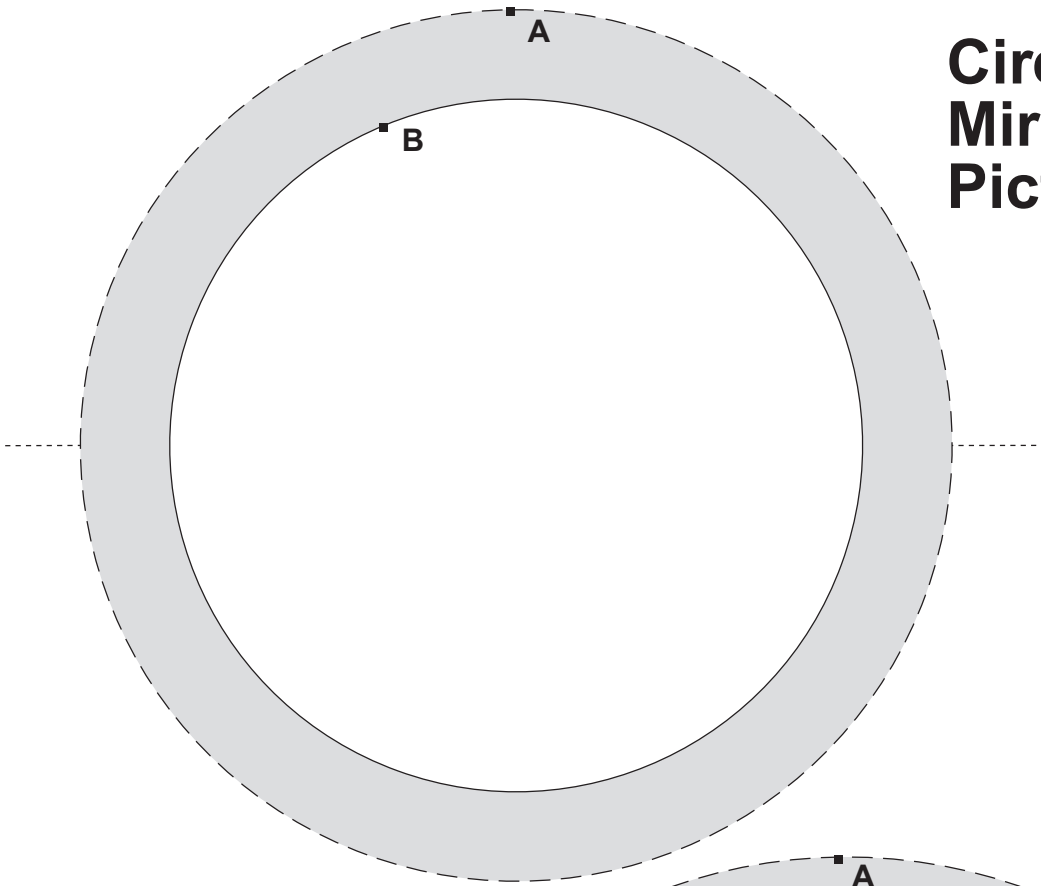

Ovals for Mirrors or Picture Frames

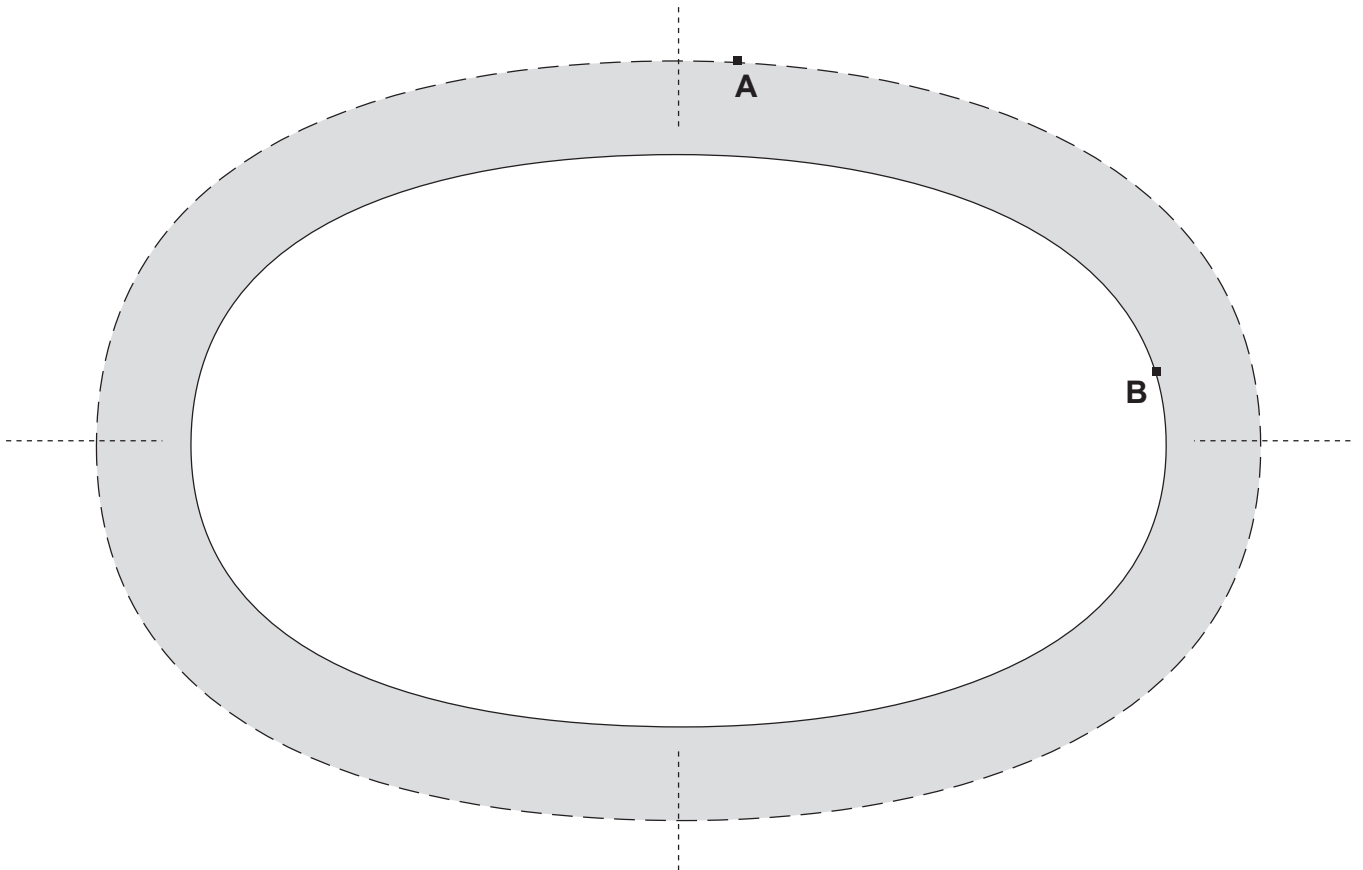
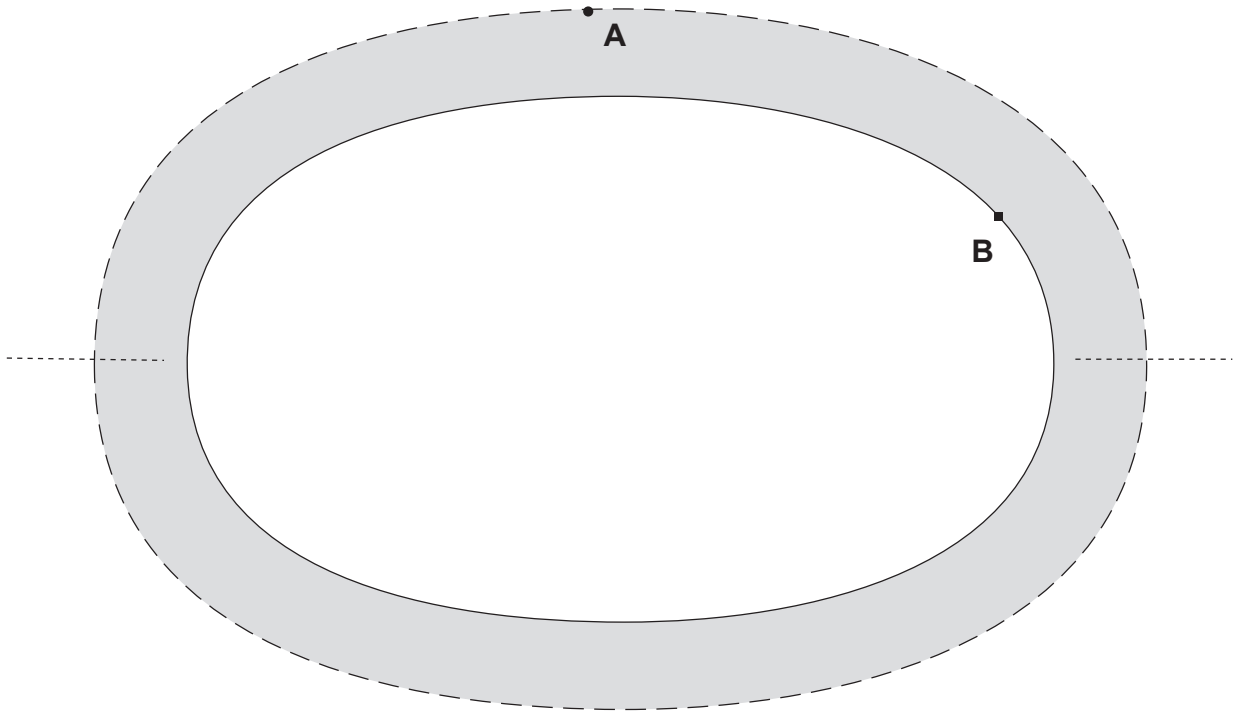

Heart for Mirrors or Picture Frames

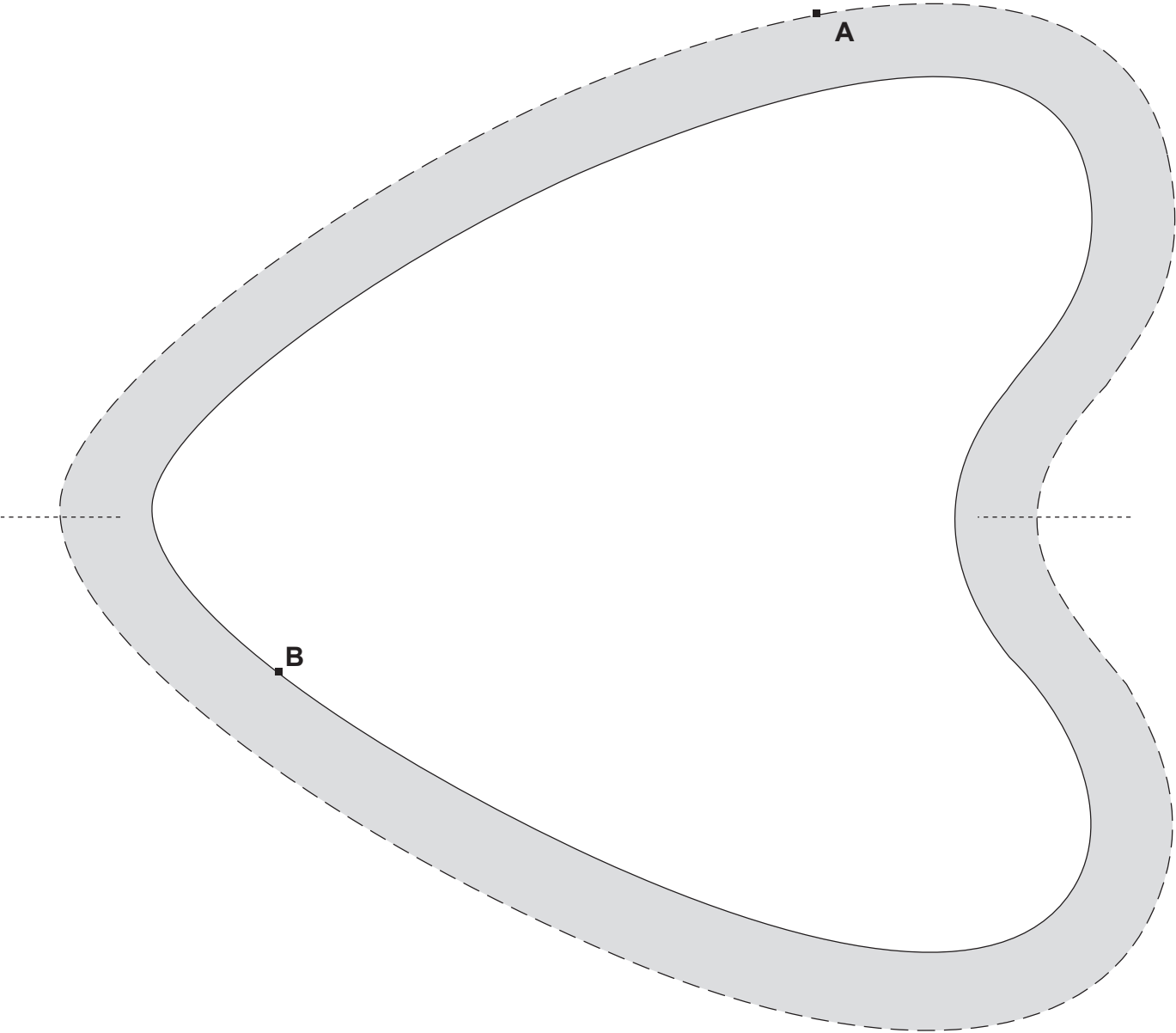

Heart for Mirrors or Picture Frames

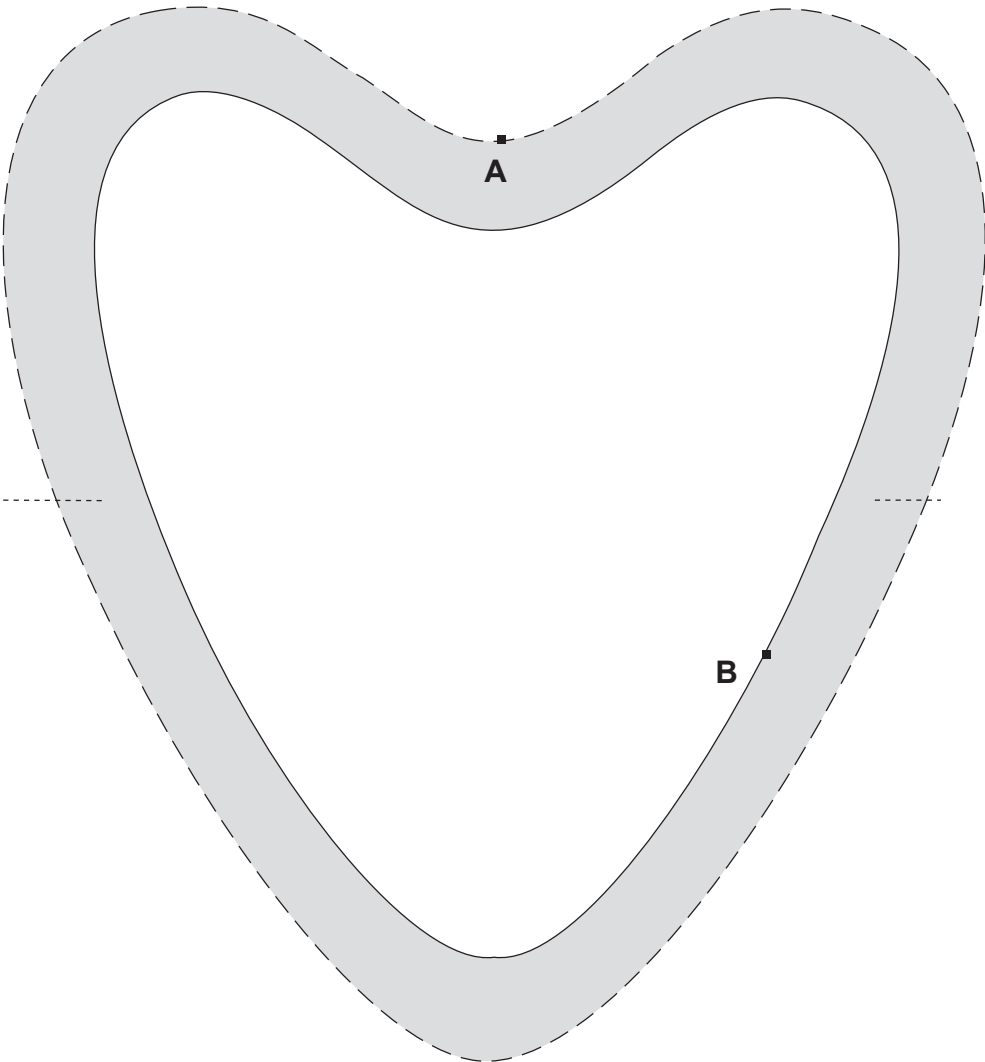

Numbers

The following numbers can be used with a few of the patterns to customize them for birthdays, anniversaries, or other special occasions. The patterns that allow for this are found on pages 15, 21, 26, and 37. On page 37, the word LUV can be removed and replaced with the numbers of your choice.

0 1 2 3 4 5 6 7 8 9

10 15 20 25 30

35 40 45 50 55

60 65 70 75 80

85 90 95 100

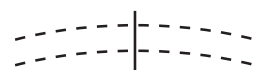
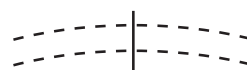
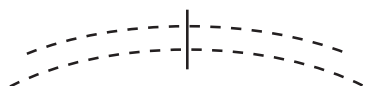
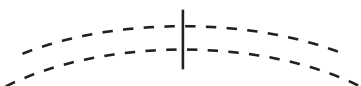

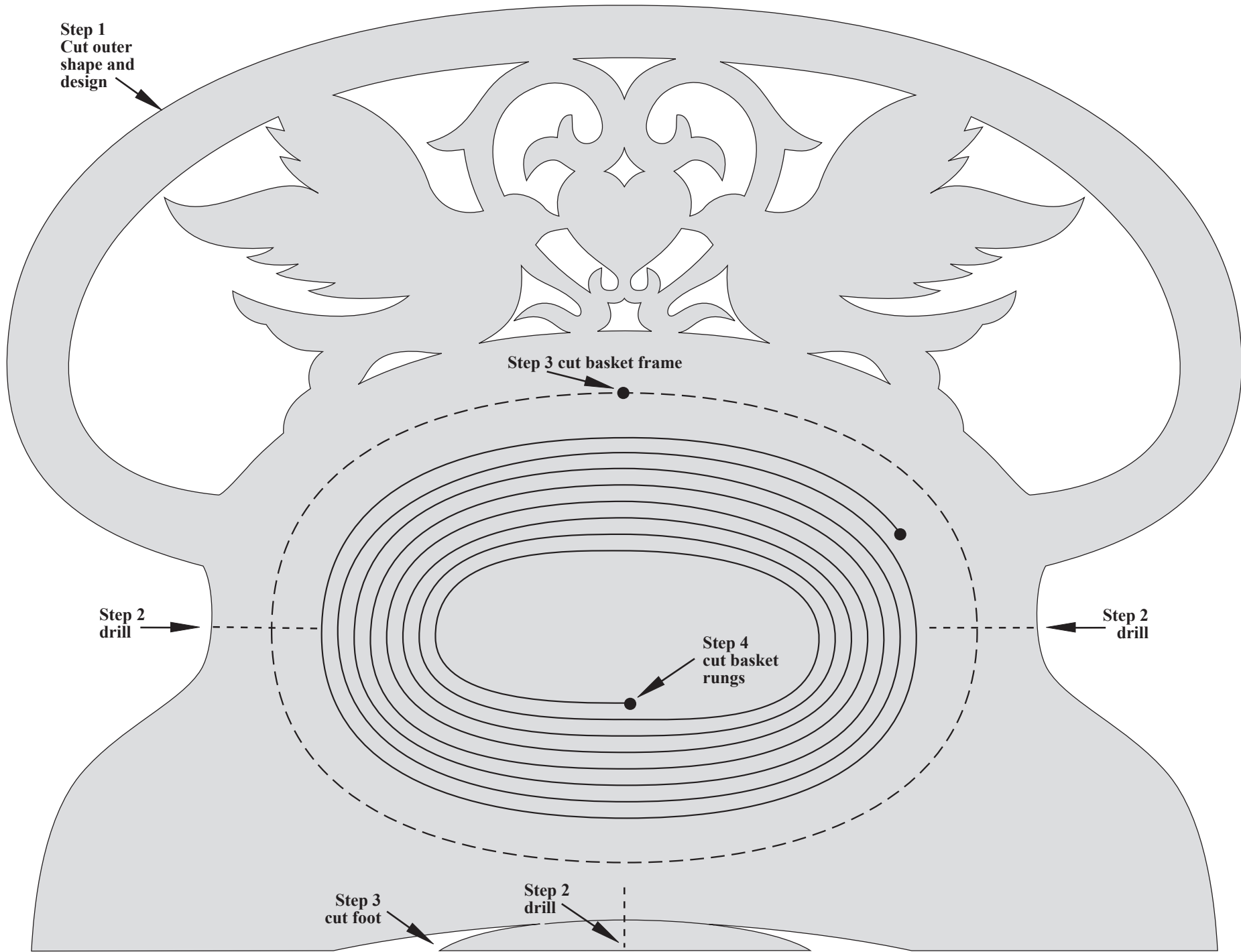

Step 1
Cut outer
shape and
design

Step 3 cut basket frame

Step 2
drill

Step 2
drill

Step 4
cut basket
rungs

Step 3
cut foot

Step 2
drill

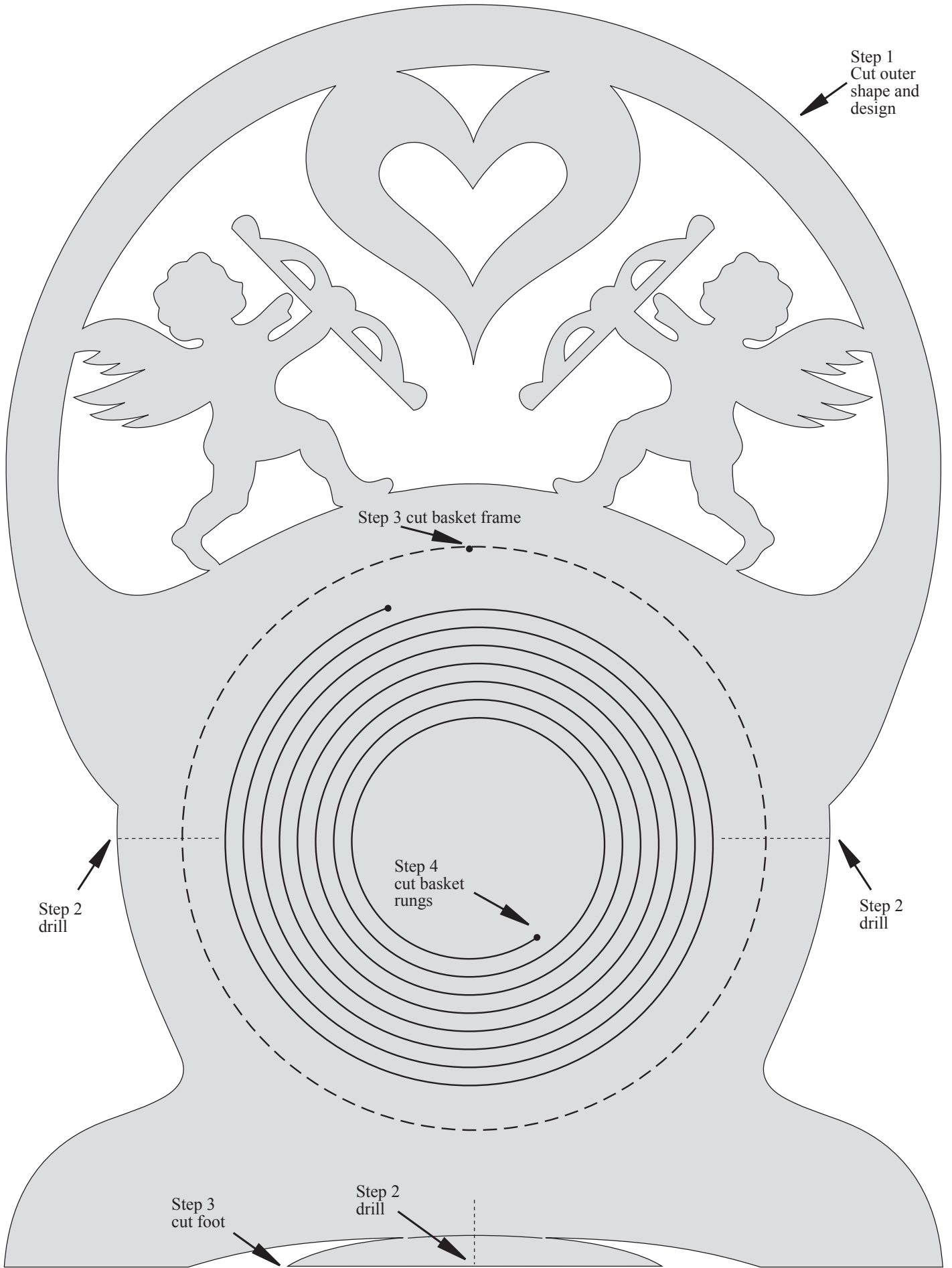

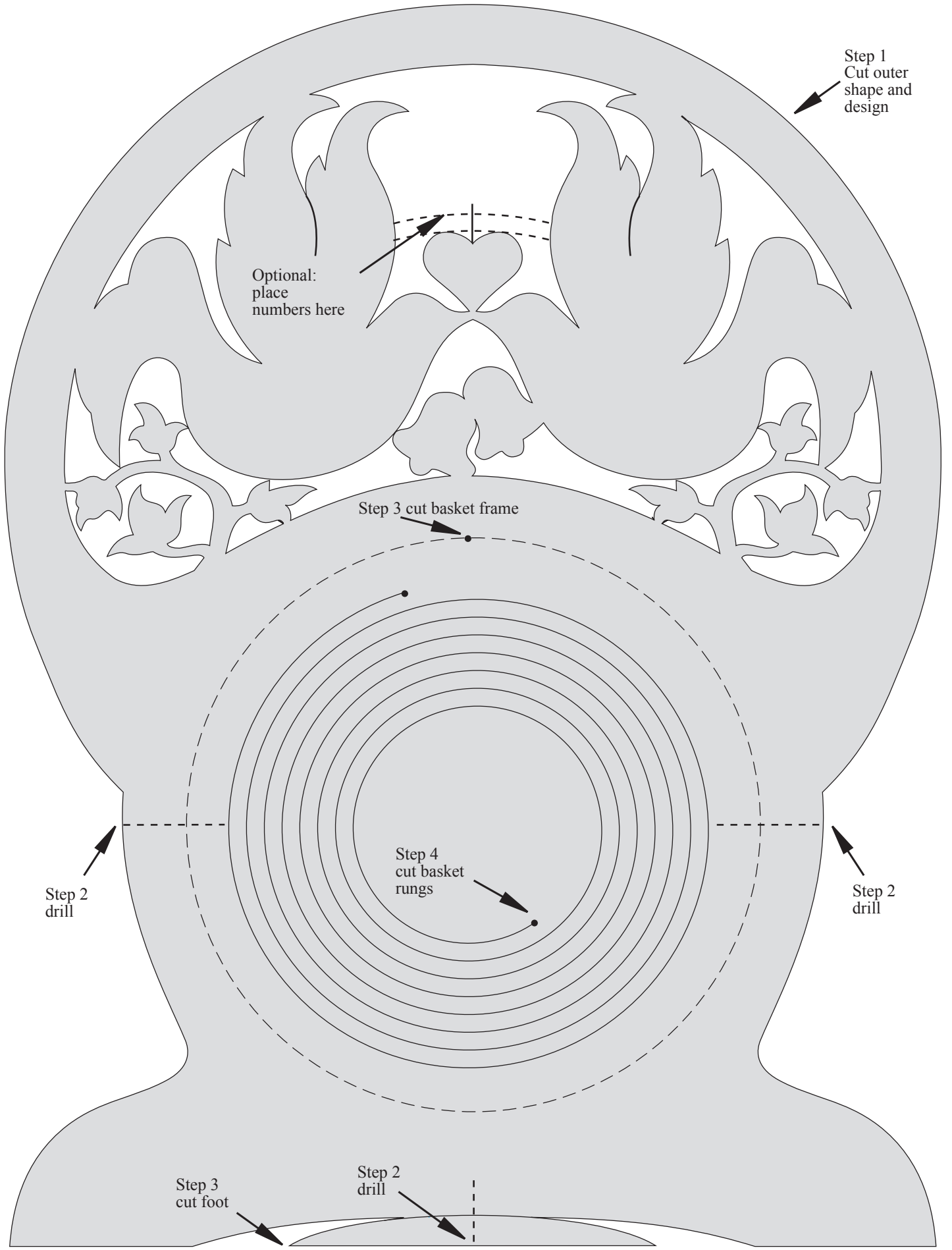

Step 1
Cut outer
shape and
design

Optional:
place
numbers here

Step 3 cut basket frame

Step 4
cut basket
rungs

Step 2
drill

Step 2
drill

Step 3
cut foot

Step 2
drill

Step 1
Cut outer
shape and
design

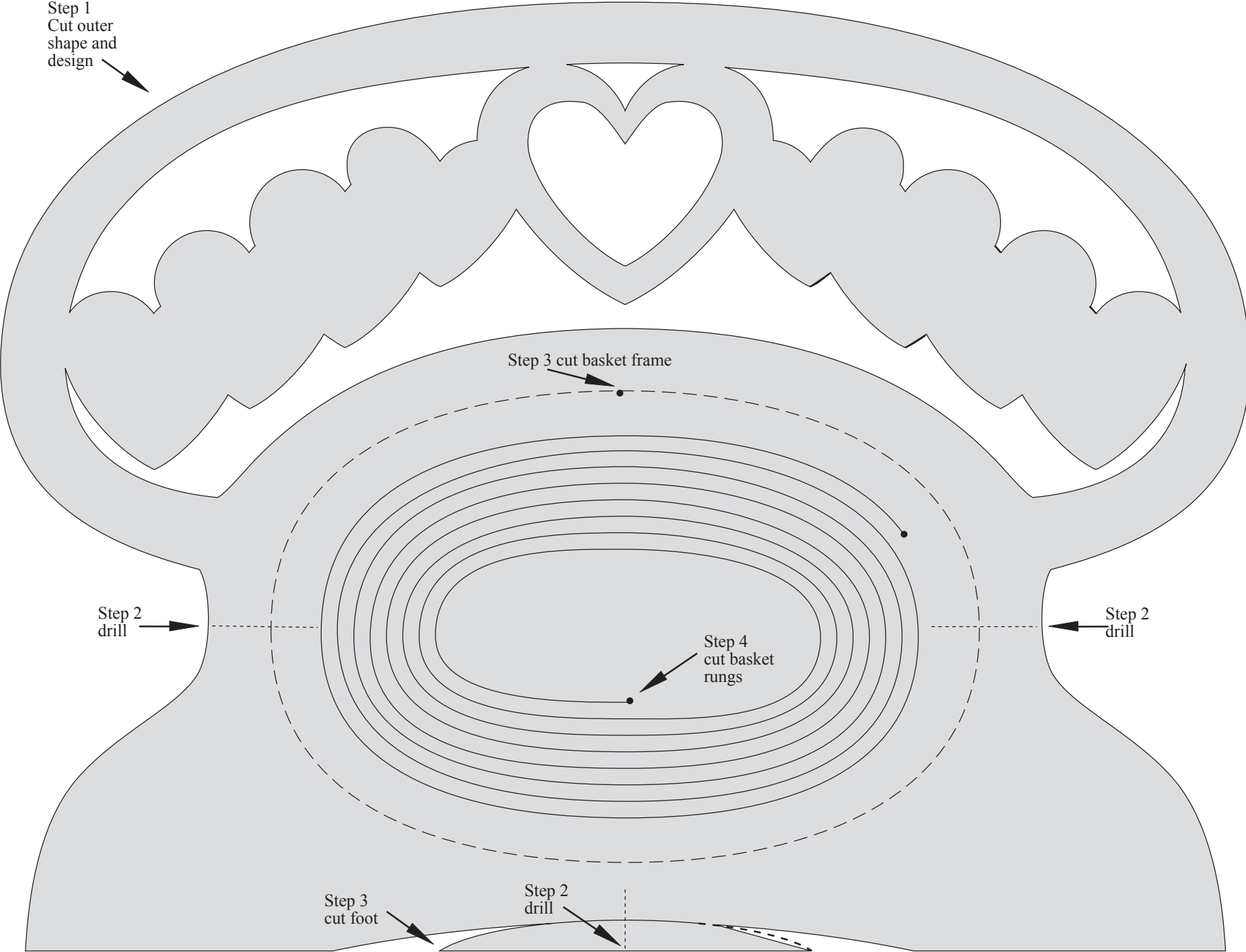

Step 3 cut basket frame

Step 2
drill

Step 2
drill

Step 4
cut basket
rungs

Step 3
cut foot

Step 2
drill

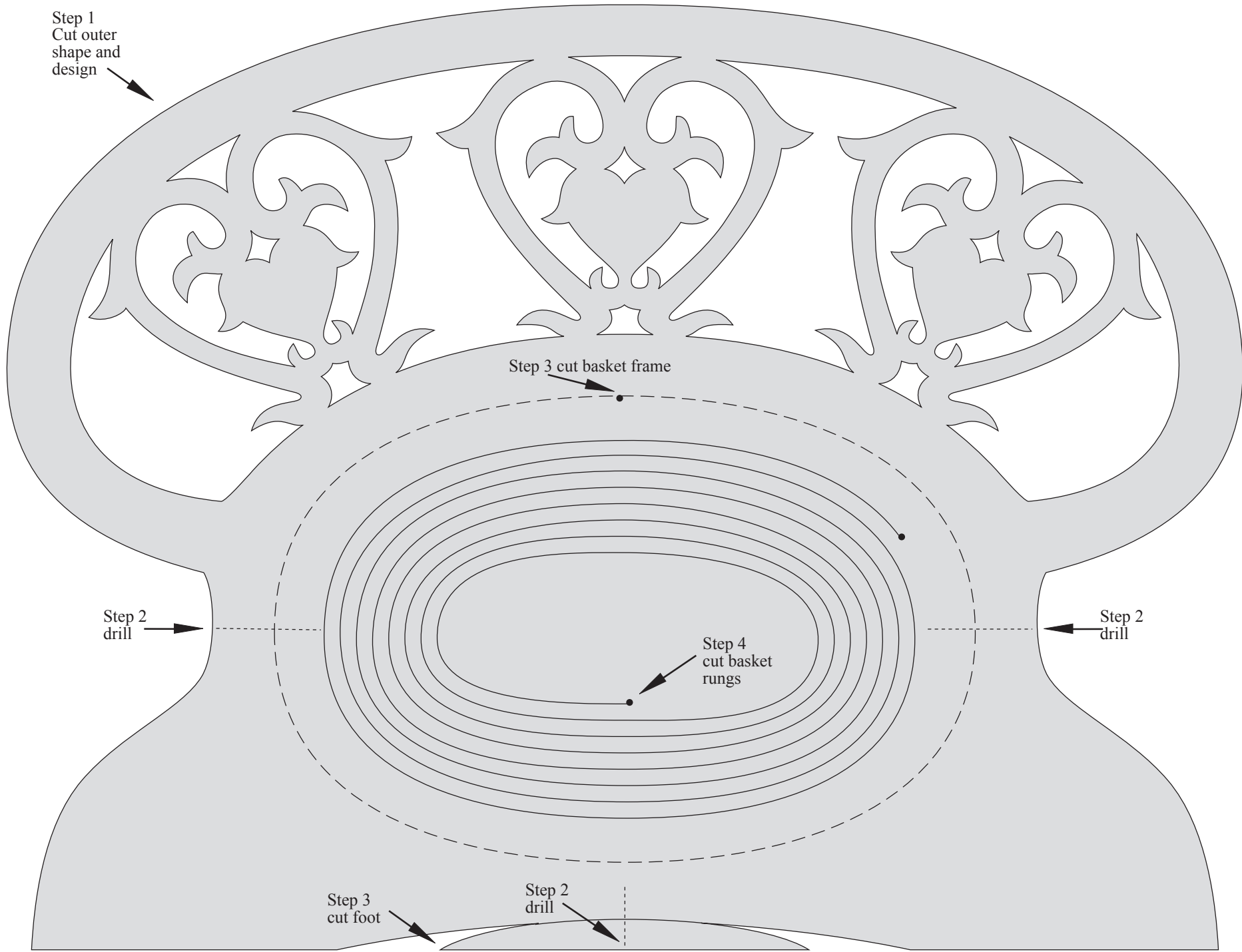

Step 1
Cut outer
shape and
design

Step 3 cut basket frame

Step 2
drill

Step 2
drill

Step 4
cut basket
rungs

Step 3
cut foot

Step 2
drill

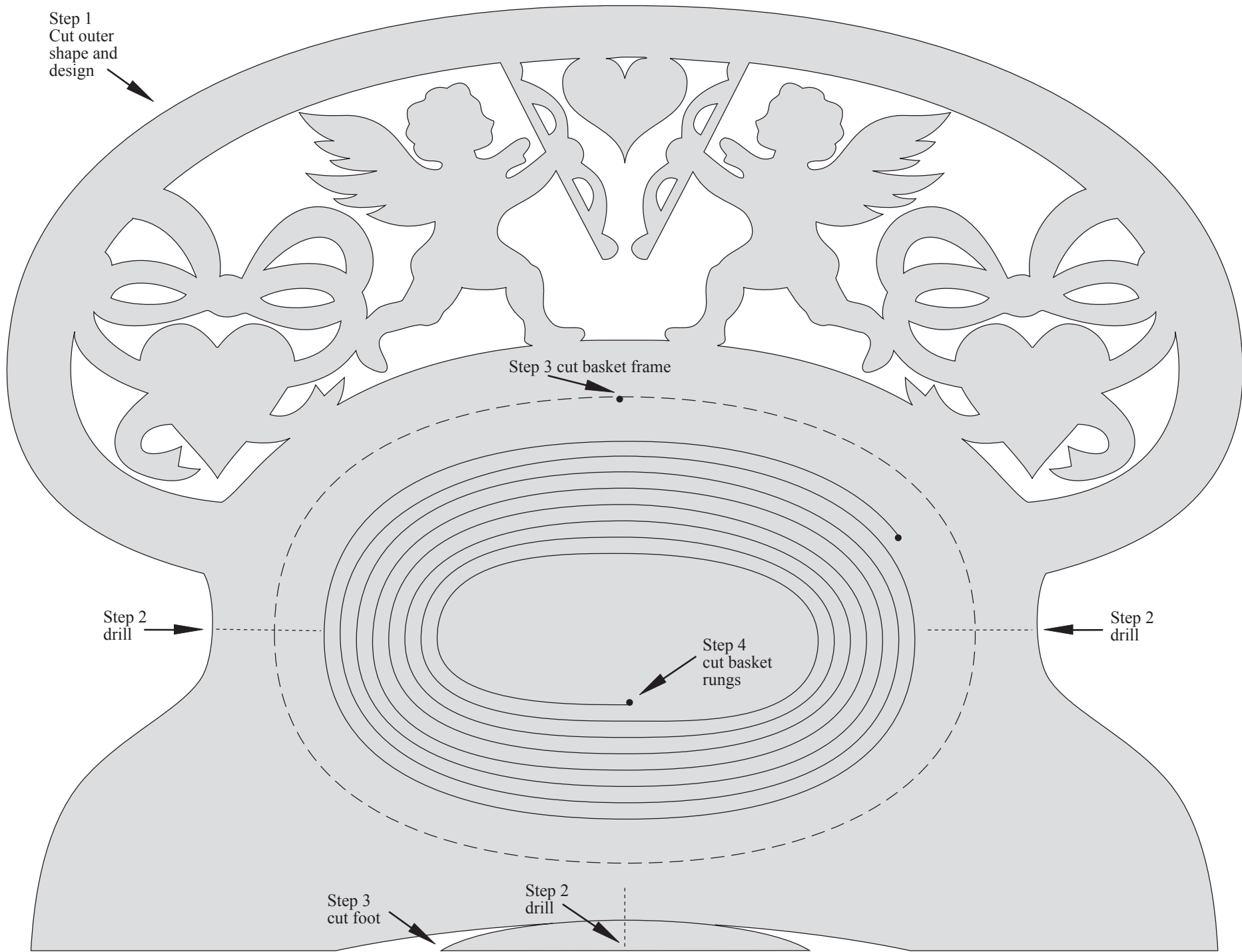

Step 1
Cut outer
shape and
design

Step 3 cut basket frame

Step 2
drill

Step 2
drill

Step 4
cut basket
rungs

Step 3
cut foot

Step 2
drill

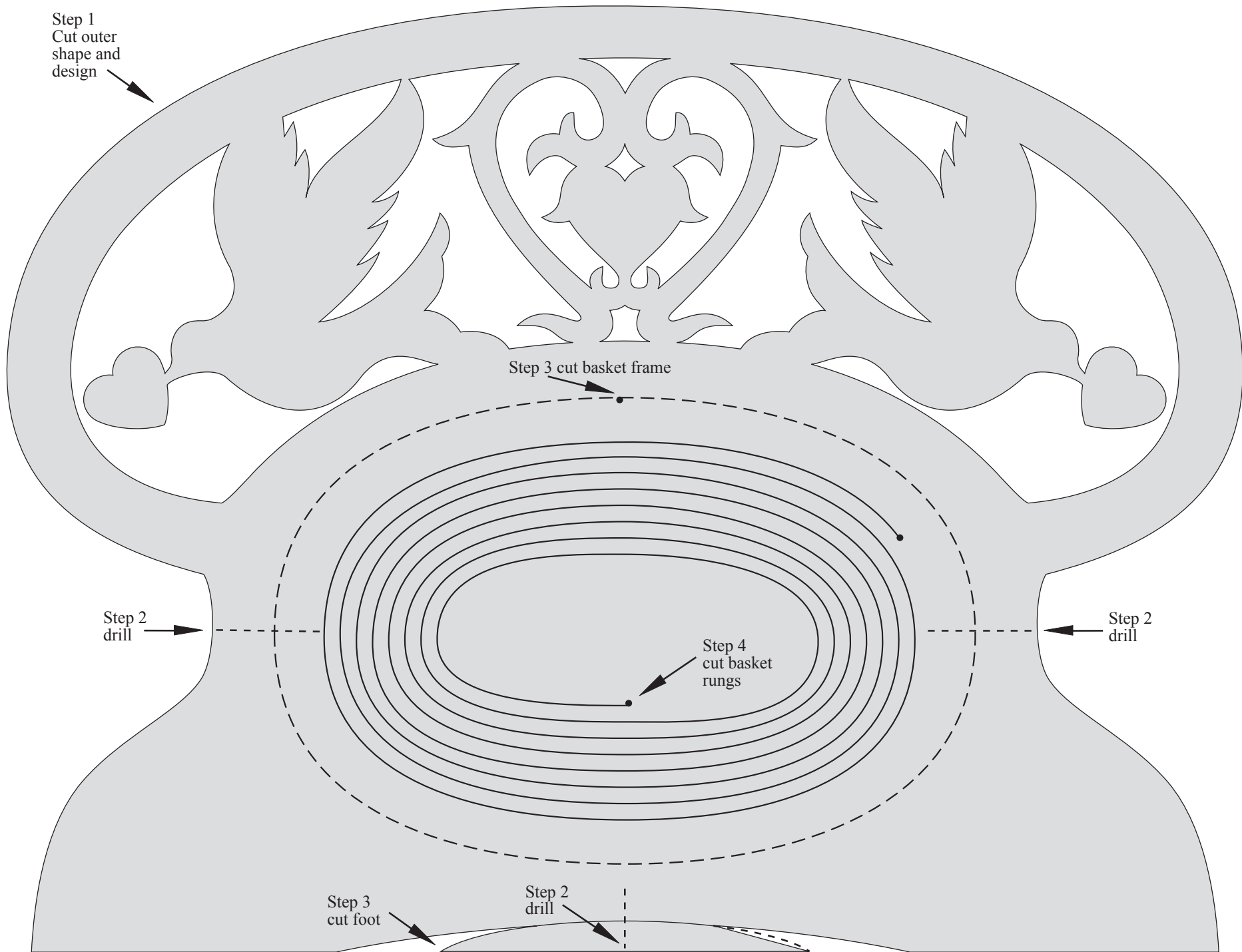

Step 1
Cut outer
shape and
design

Step 3 cut basket frame

Step 2
drill

Step 2
drill

Step 4
cut basket
rungs

Step 3
cut foot

Step 2
drill

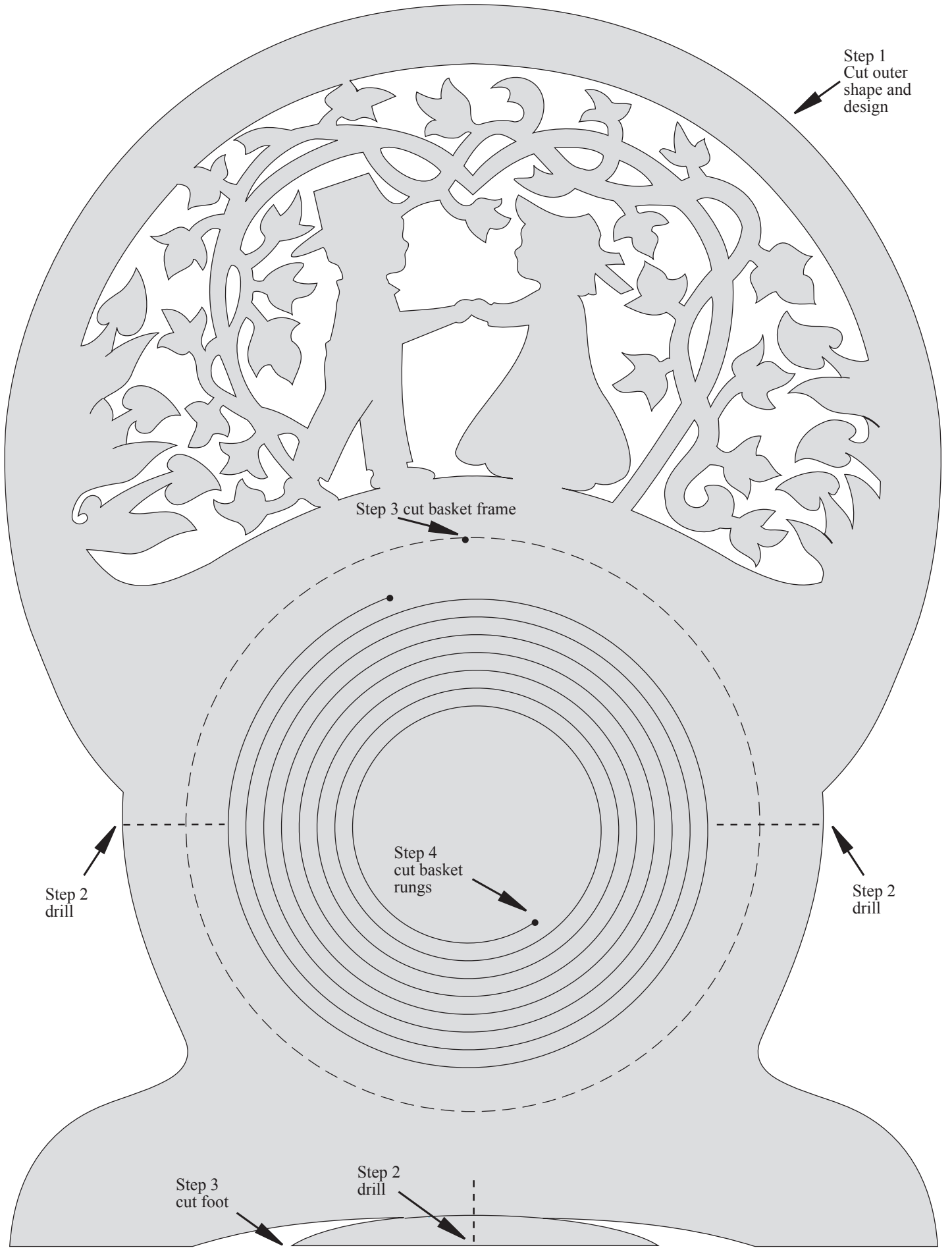

Step 1
Cut outer
shape and
design

Step 3 cut basket frame

Step 4
cut basket
rungs

Step 2
drill

Step 2
drill

Step 3
cut foot

Step 2
drill

Step 1
Cut outer
shape and
design



Step 3 cut basket frame



Optional: place
numbers here

Step 2
drill



Step 2
drill



Step 4
cut basket
rungs

Step 3
cut foot



Step 2
drill

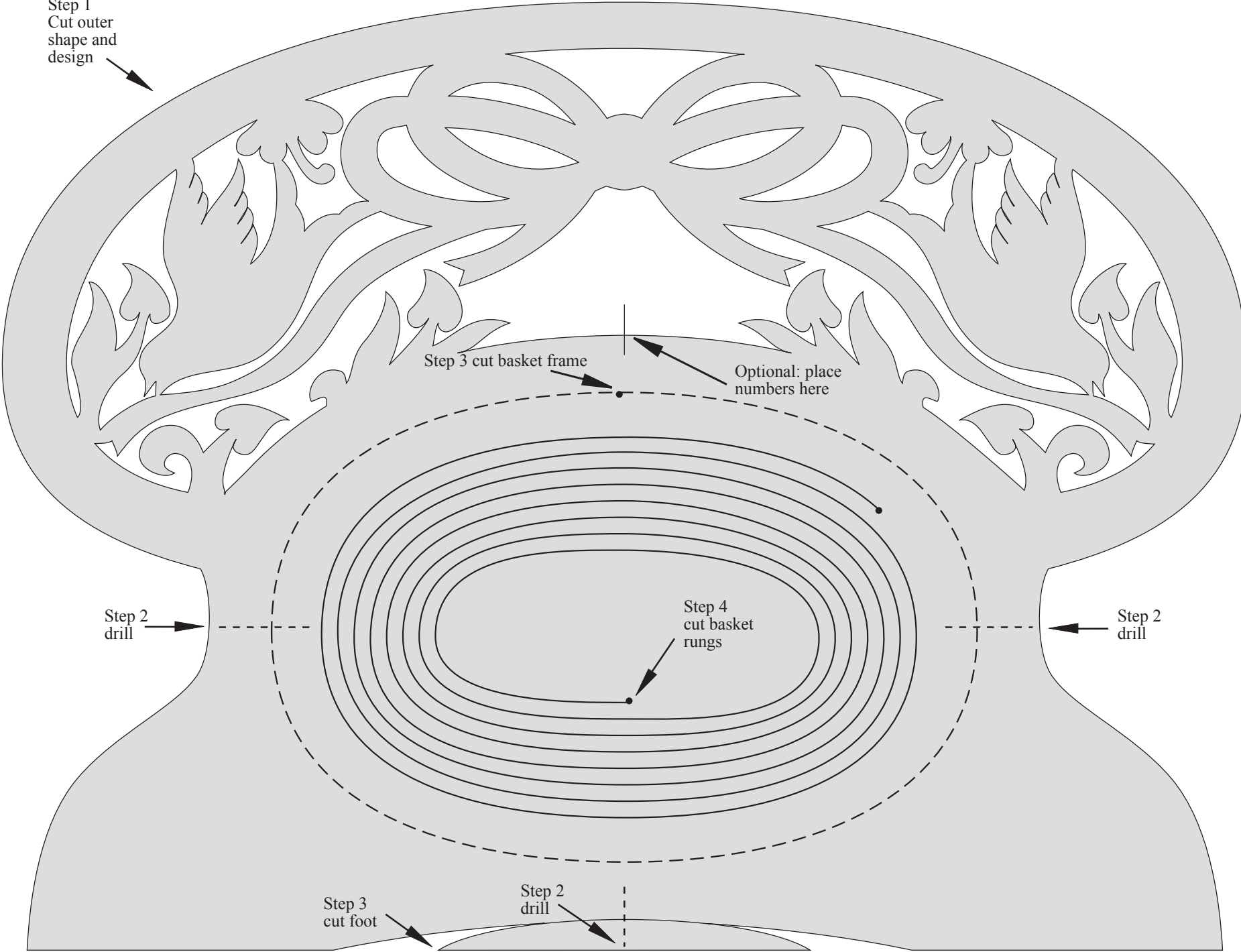

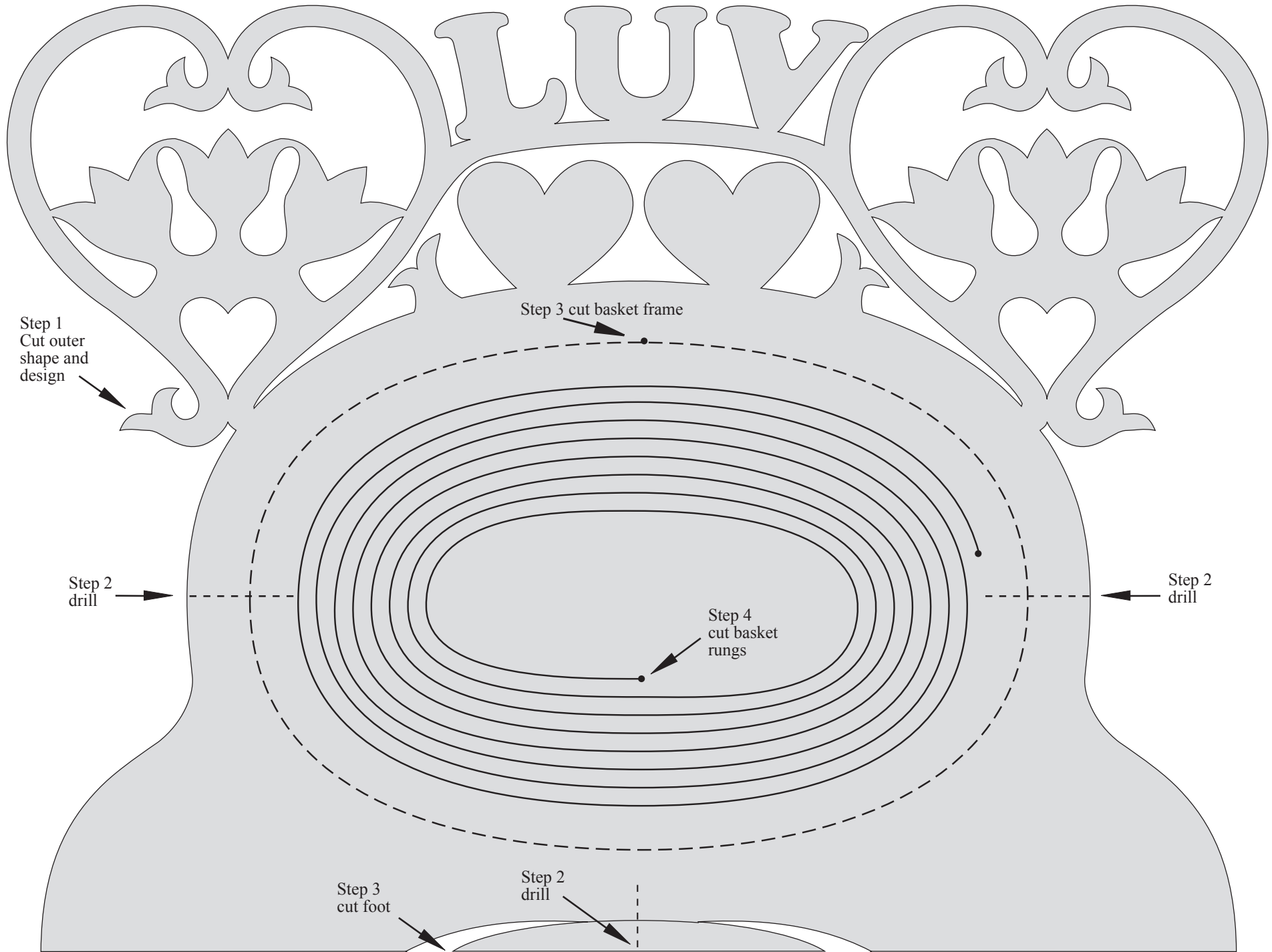

Step 1
Cut outer
shape and
design

Step 3 cut basket frame

Step 2
drill

Step 2
drill

Step 4
cut basket
rungs

Step 3
cut foot

Step 2
drill

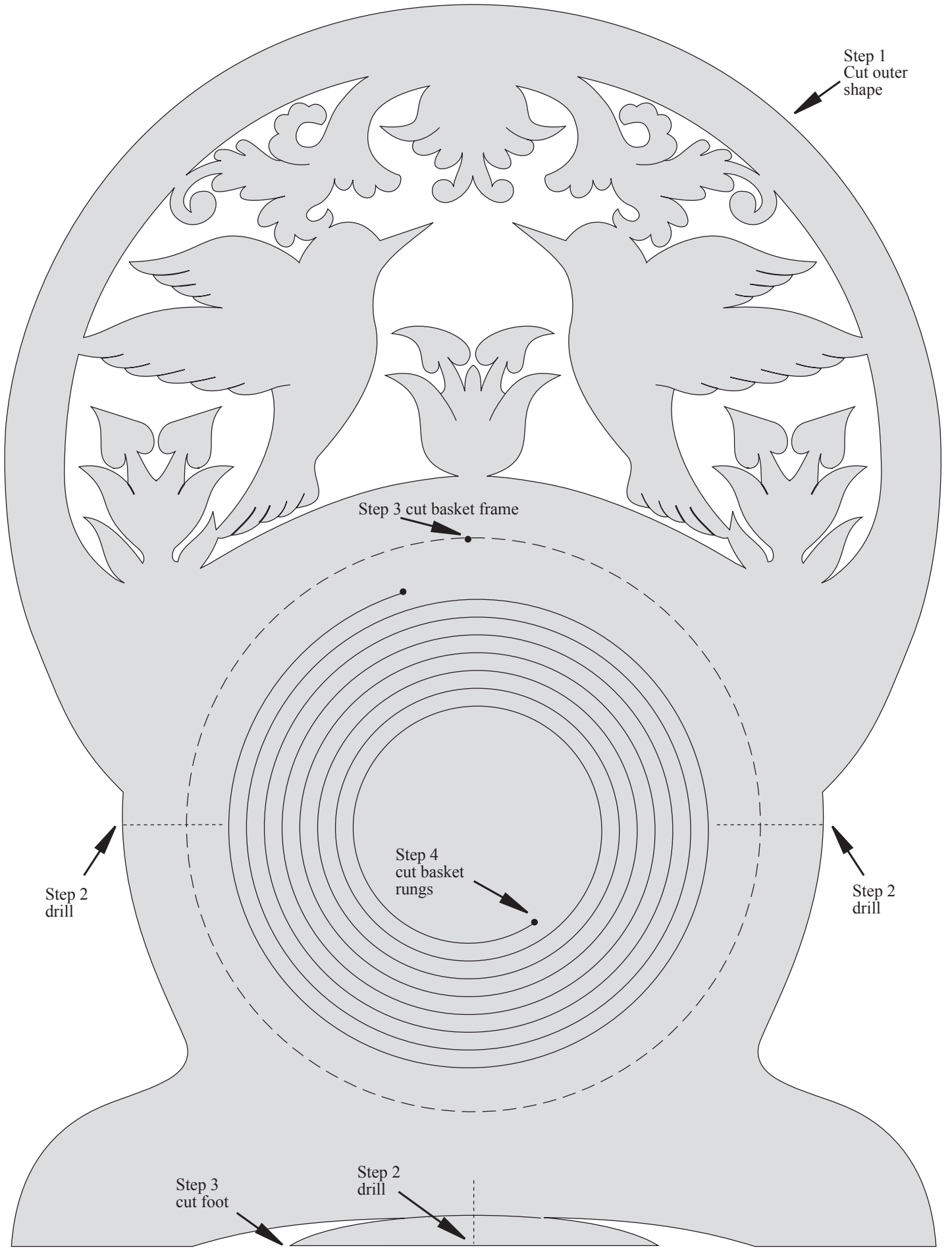

Step 1
Cut outer
shape

Step 3 cut basket frame

Step 4
cut basket
rungs

Step 2
drill

Step 2
drill

Step 3
cut foot

Step 2
drill

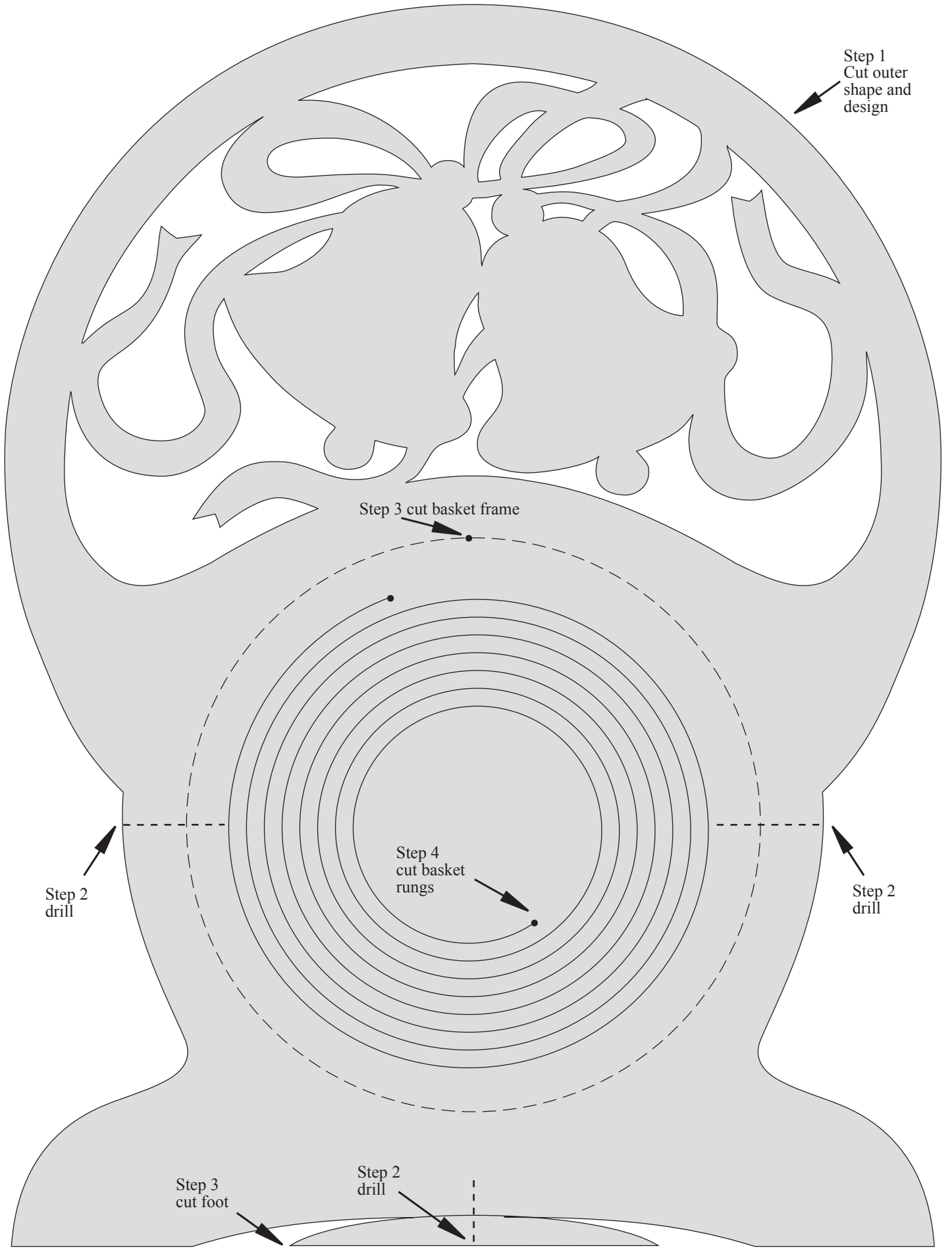

Step 1
Cut outer
shape and
design

Step 3 cut basket frame

Step 2
drill

Step 4
cut basket
rungs

Step 2
drill

Step 3
cut foot

Step 2
drill

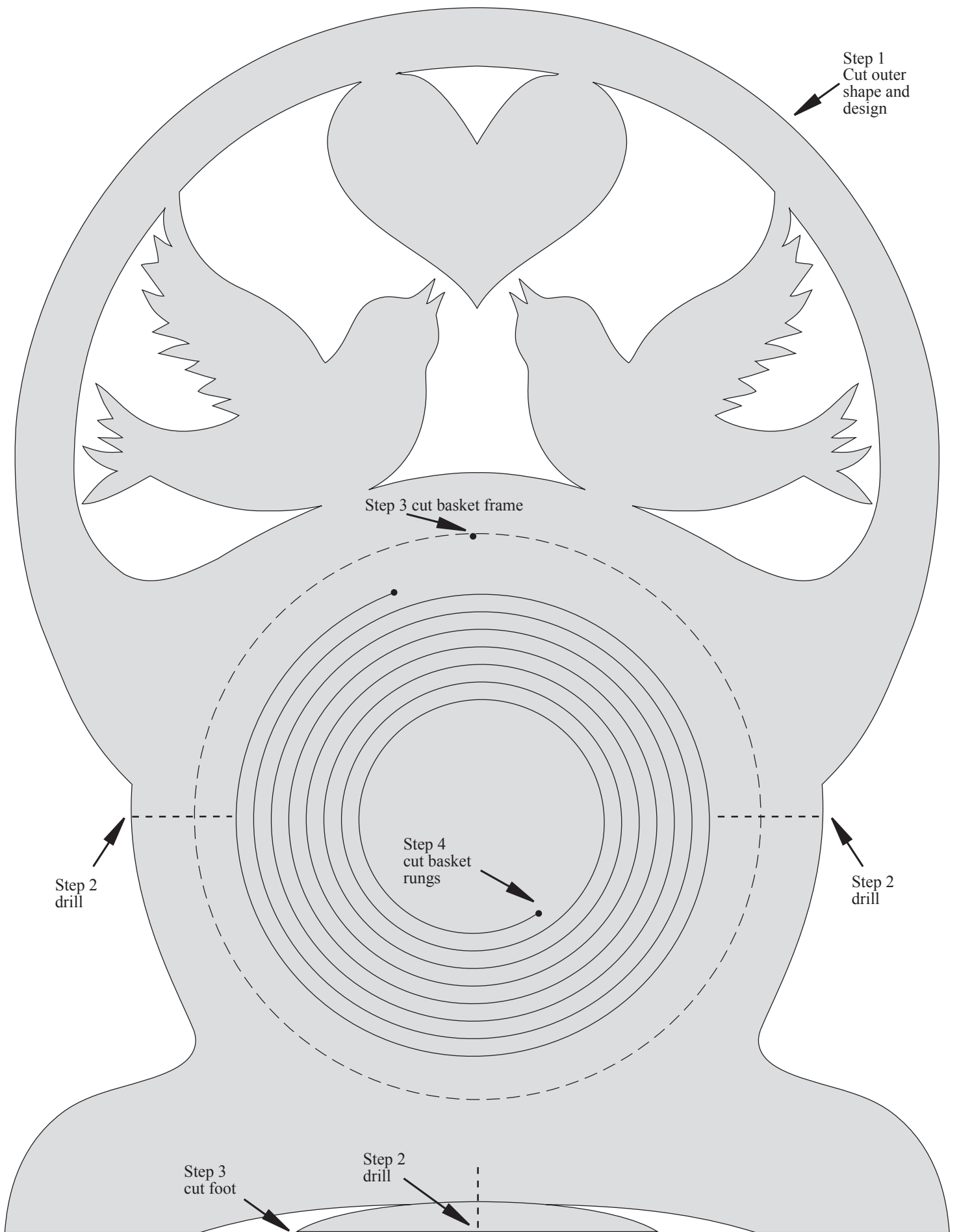

Step 1
Cut outer
shape and
design

Step 3 cut basket frame

Step 4
cut basket
rungs

Step 2
drill

Step 2
drill

Step 3
cut foot

Step 2
drill

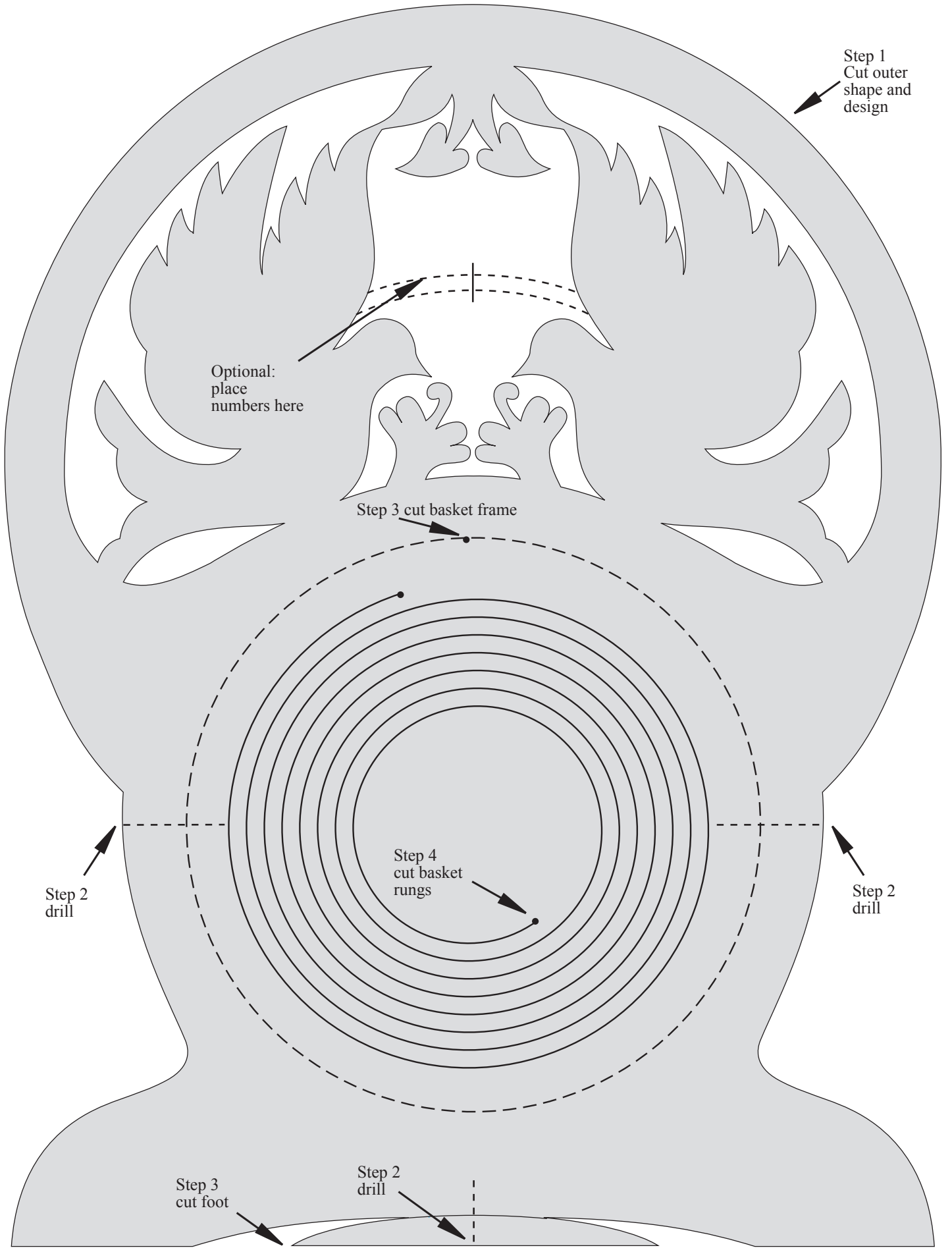

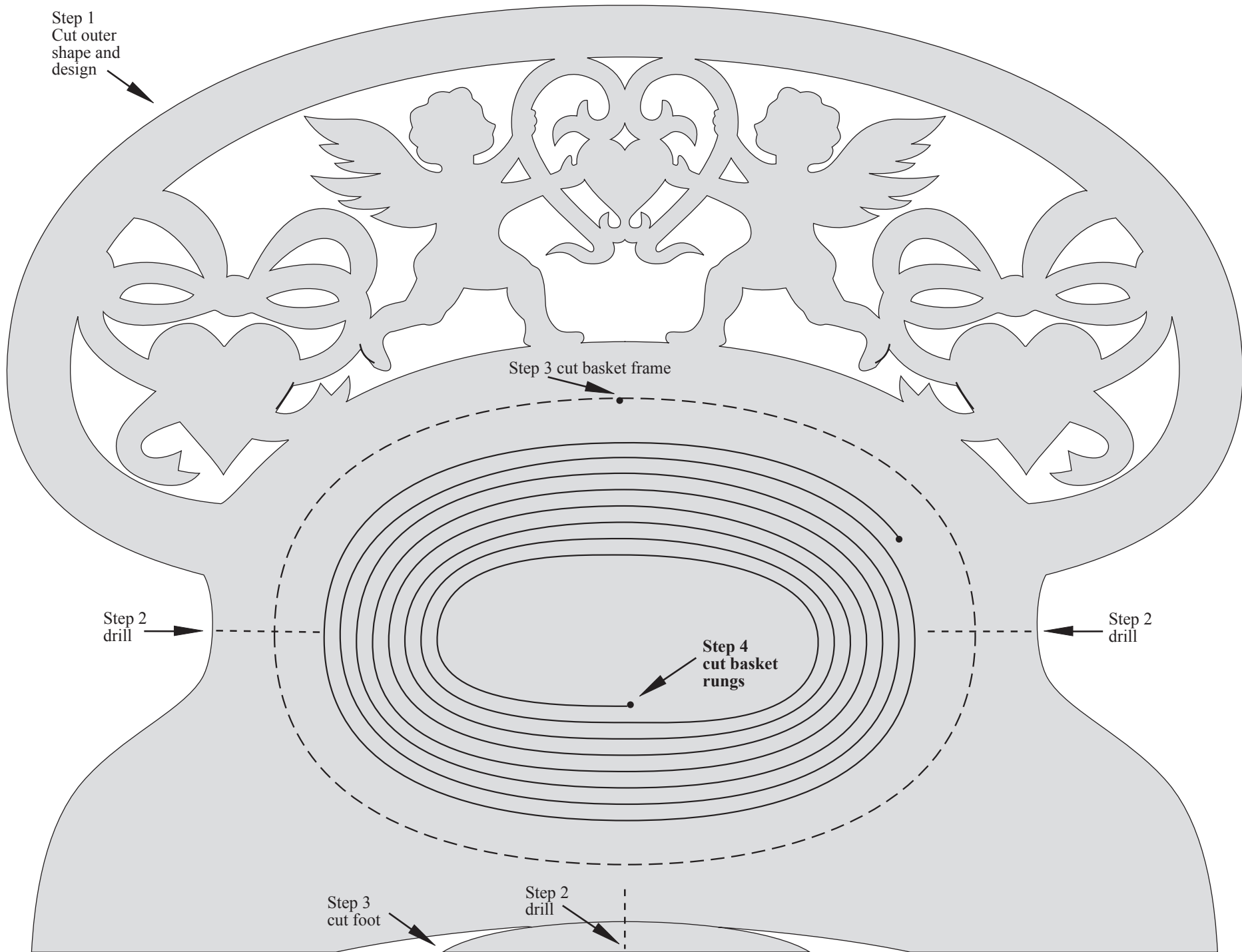

Step 1
Cut outer
shape and
design

Step 3 cut basket frame

Step 2
drill

Step 2
drill

Step 4
cut basket
rungs

Step 3
cut foot

Step 2
drill

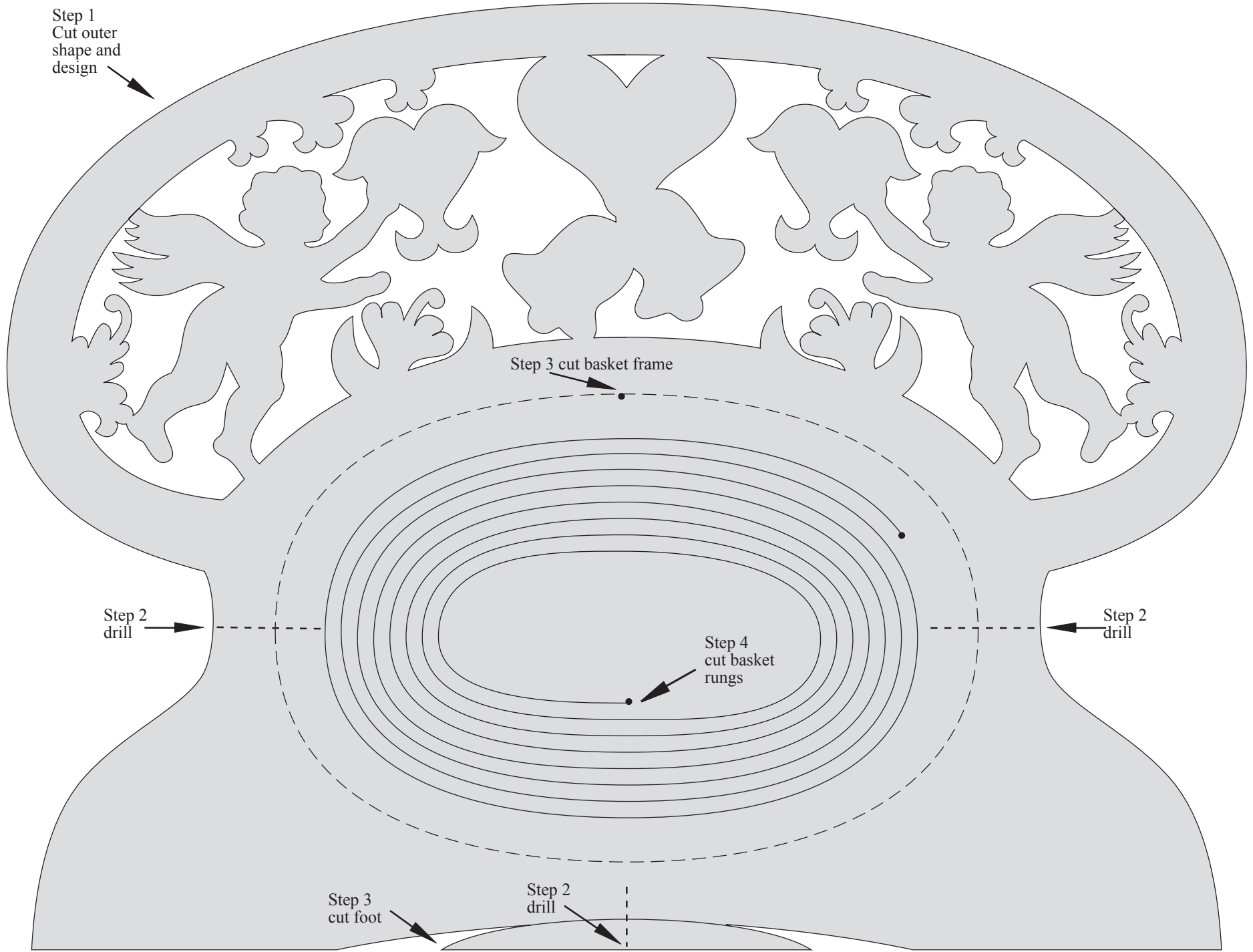

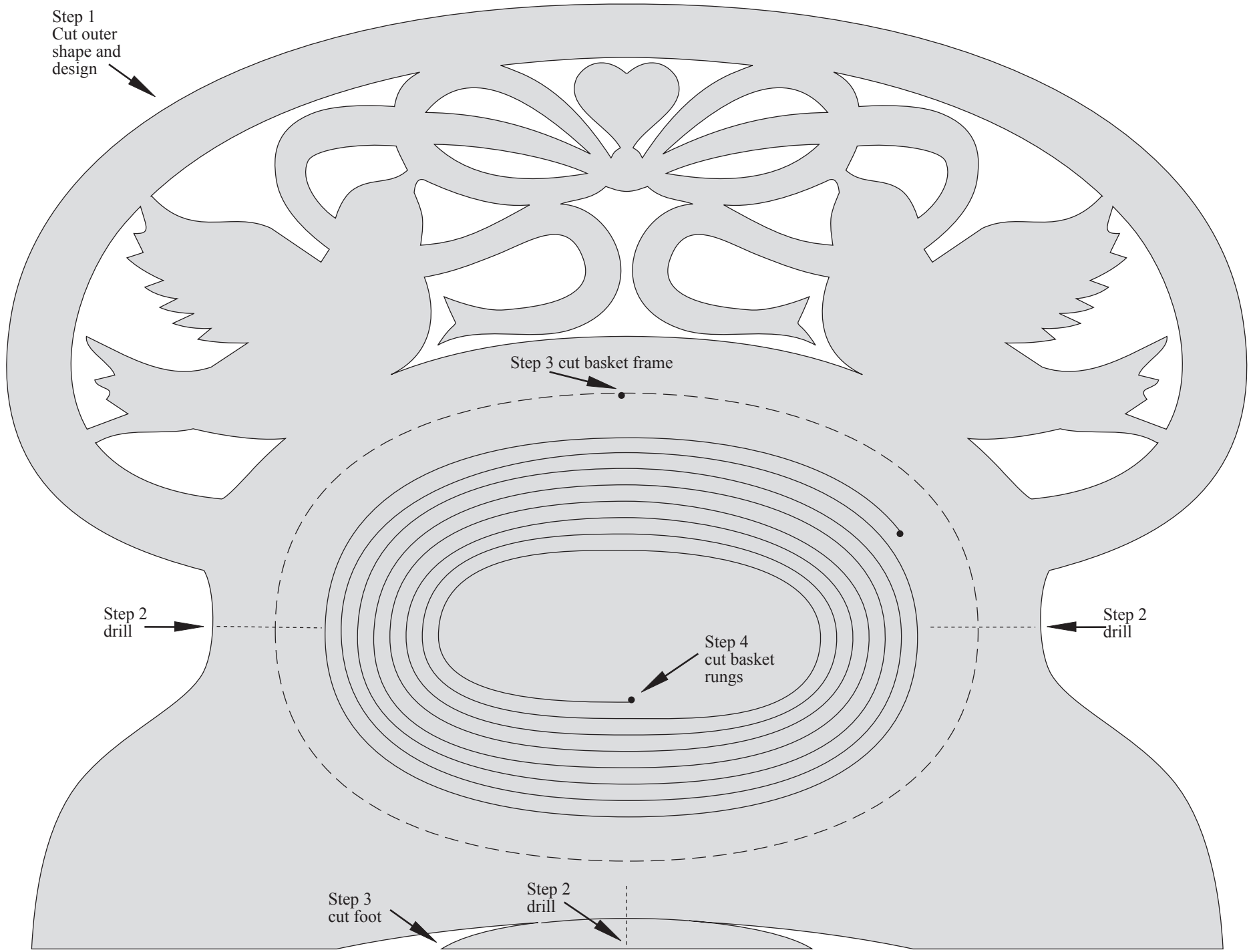

Step 1
Cut outer
shape and
design

Step 3 cut basket frame

Step 2
drill

Step 2
drill

Step 4
cut basket
rungs

Step 3
cut foot

Step 2
drill

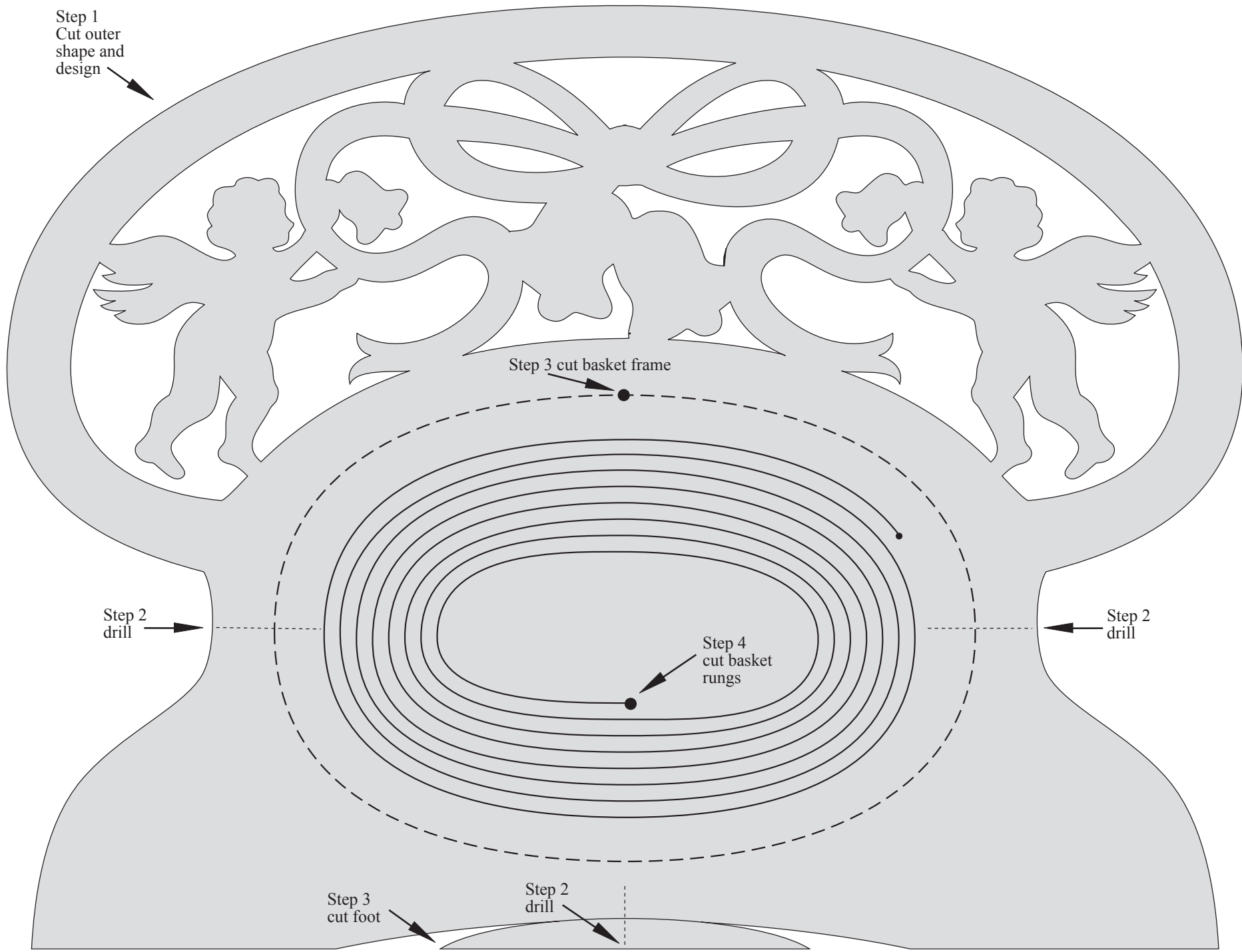

Step 1
Cut outer
shape and
design

Step 3 cut basket frame

Step 2
drill

Step 2
drill

Step 4
cut basket
rungs

Step 3
cut foot

Step 2
drill

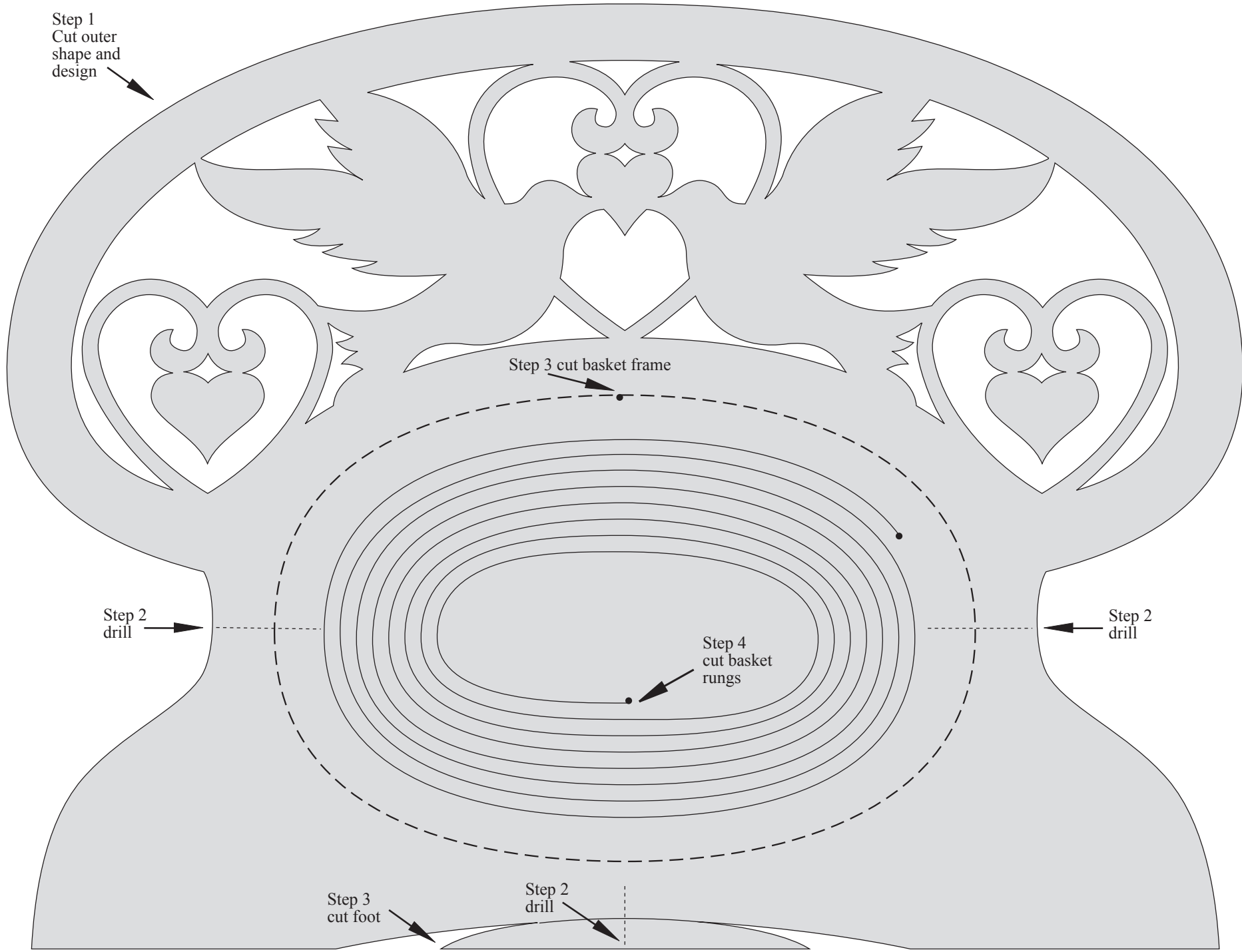

Step 1
Cut outer
shape and
design

Step 3 cut basket frame

Step 2
drill

Step 2
drill

Step 4
cut basket
rungs

Step 3
cut foot

Step 2
drill

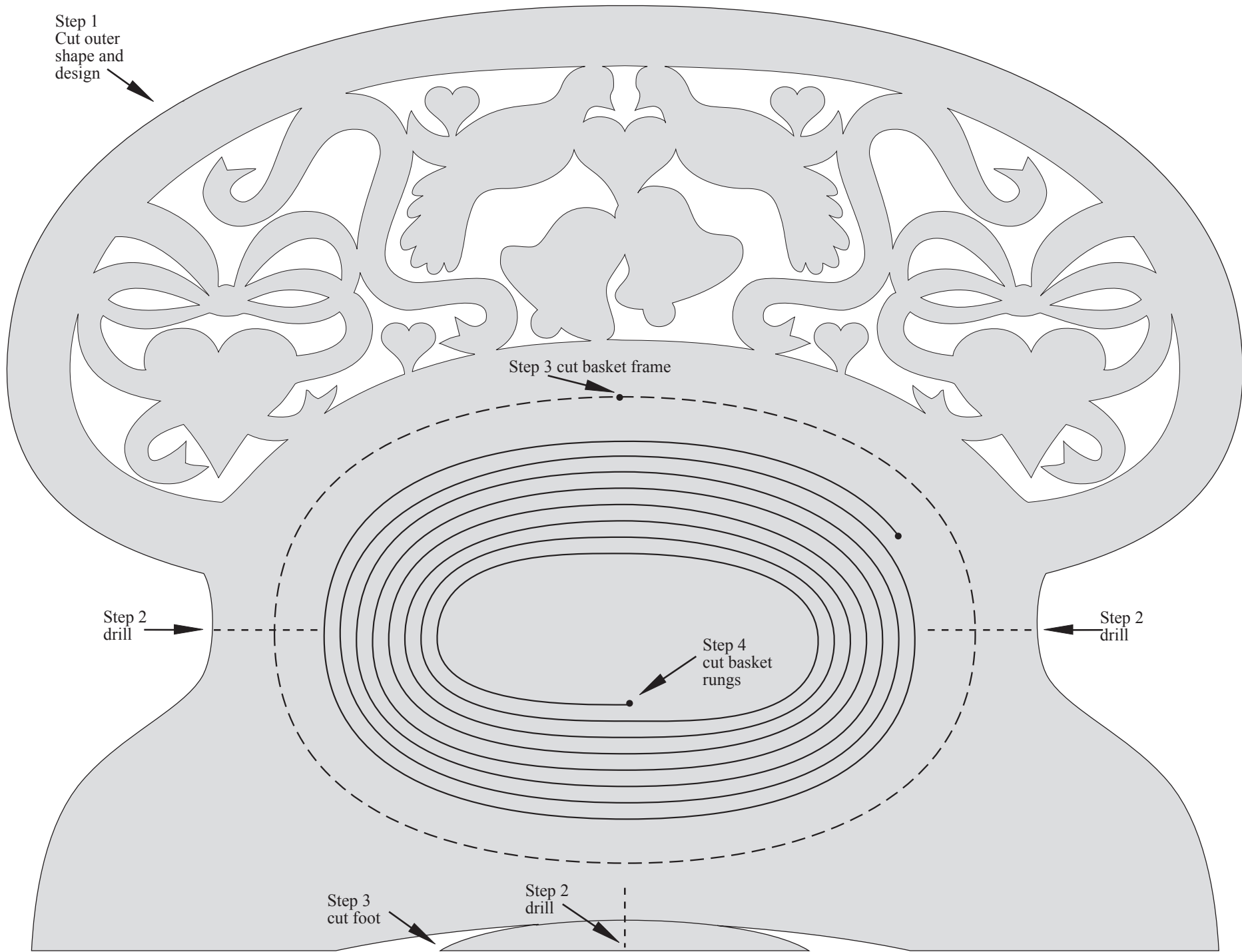

Step 1
Cut outer
shape and
design

Step 3 cut basket frame

Step 2
drill

Step 2
drill

Step 4
cut basket
rungs

Step 3
cut foot

Step 2
drill

Step 1
Cut outer
shape and
design

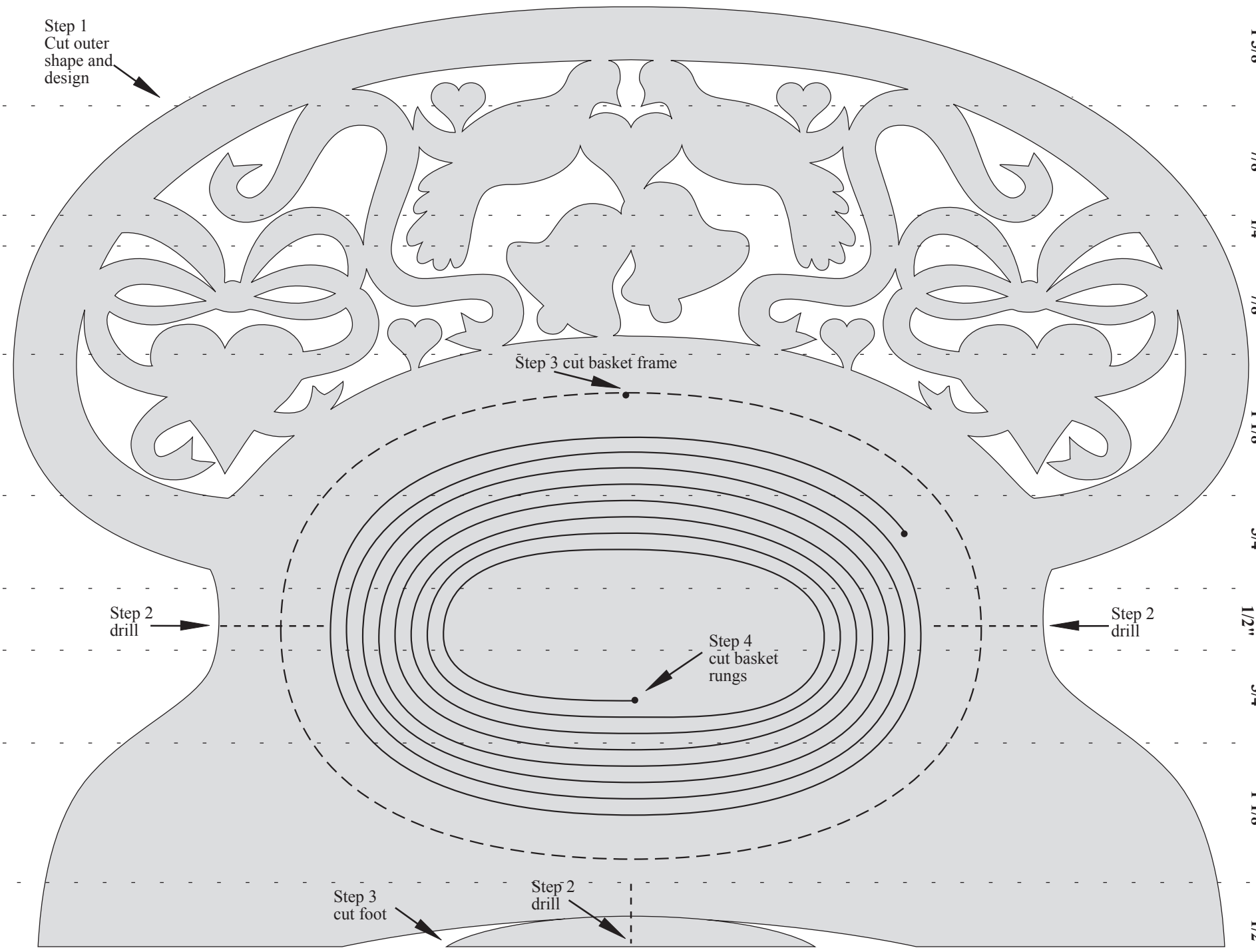

Step 3 cut basket frame

Step 2
drill

Step 2
drill

Step 4
cut basket
rungs

Step 3
cut foot

Step 2
drill



Step 1
Cut outer
shape and
design



Step 3
cut basket
frame



Step 2
drill

Step 2
drill

Step 4
cut basket
rungs



Step 3
cut foot

Step 2
drill

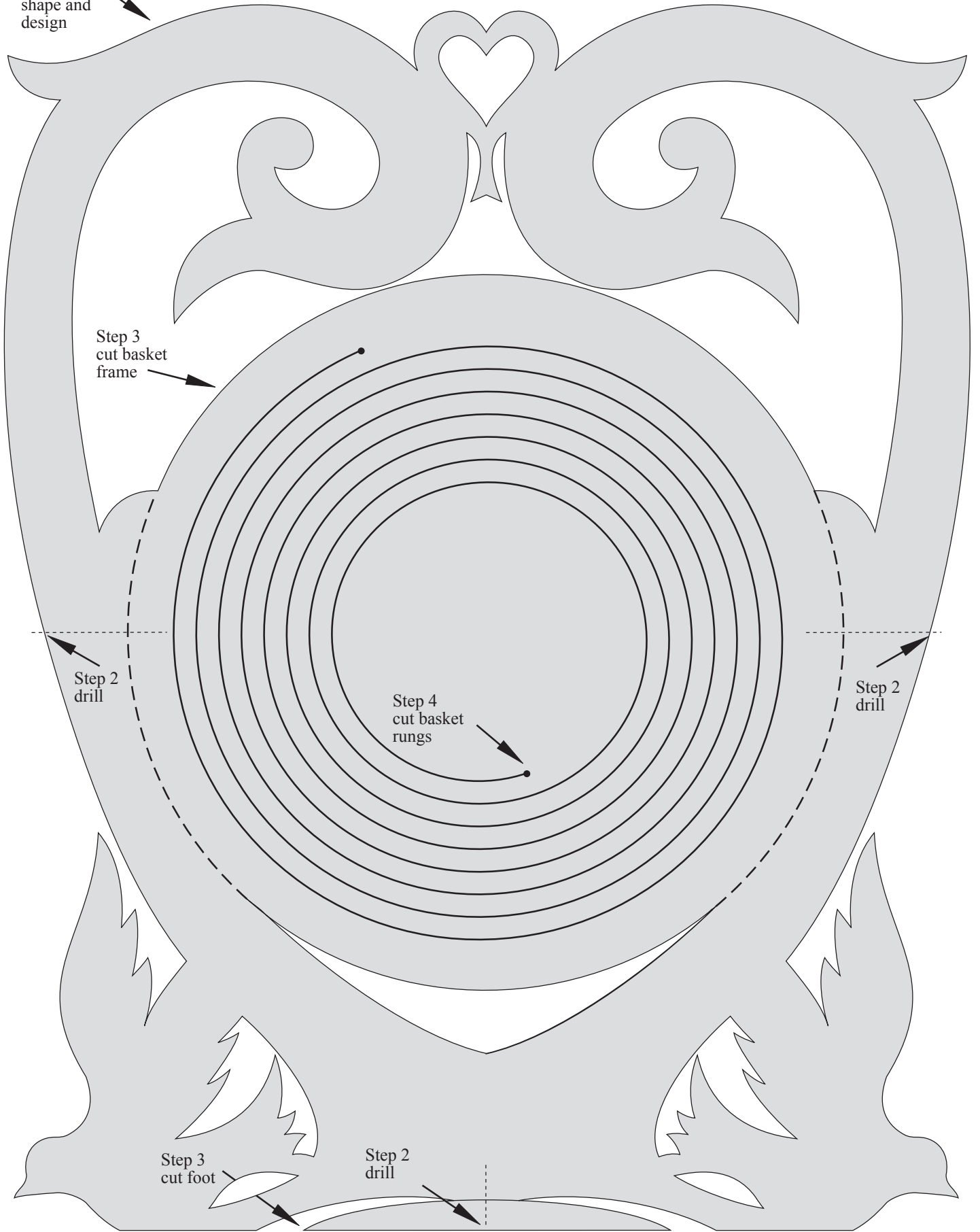
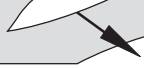

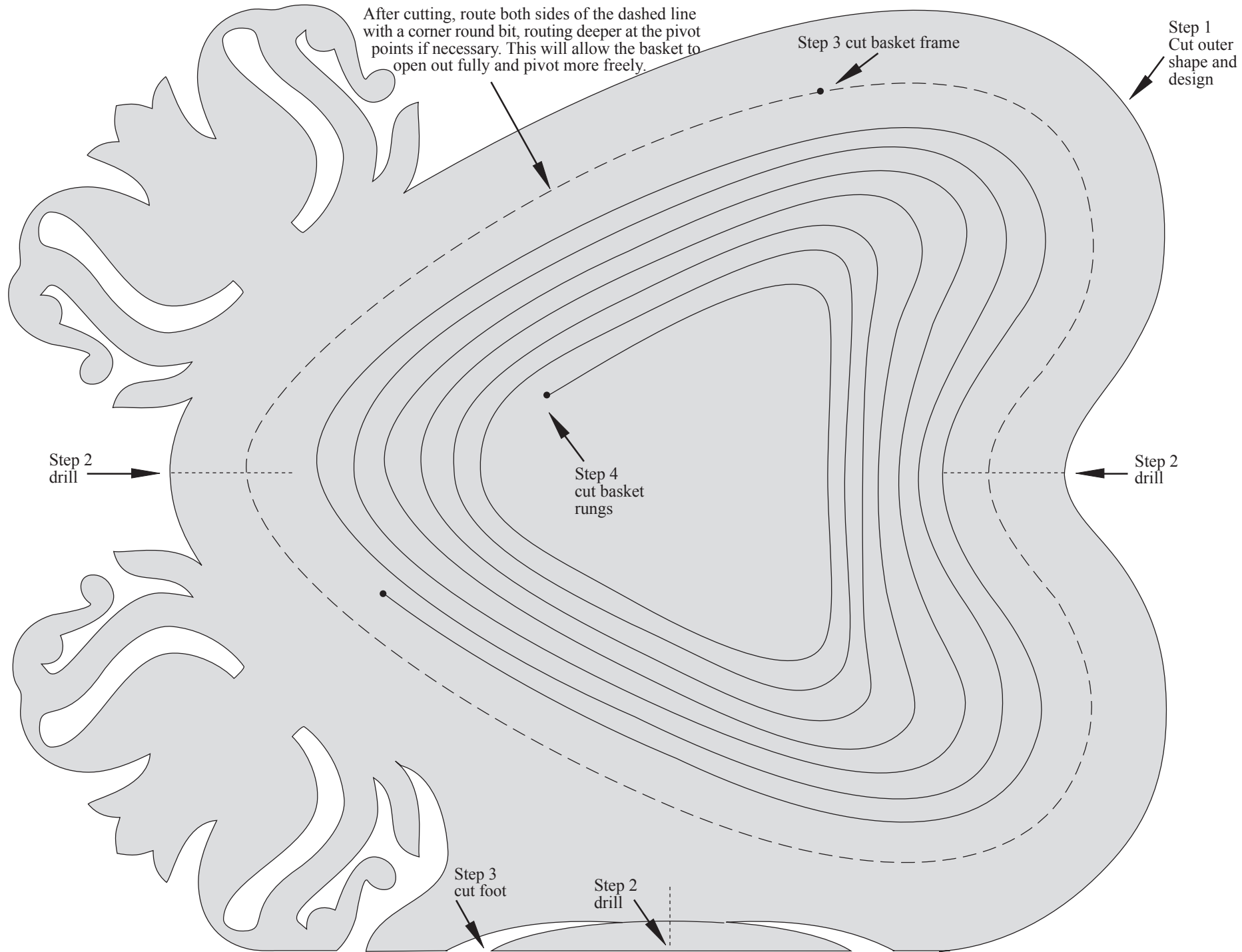

Step 1
Cut outer
shape and
design



Step 3
cut basket
frame



Step 4
cut basket
rungs



Step 2
drill

Step 2
drill

Step 3
cut foot

Step 2
drill

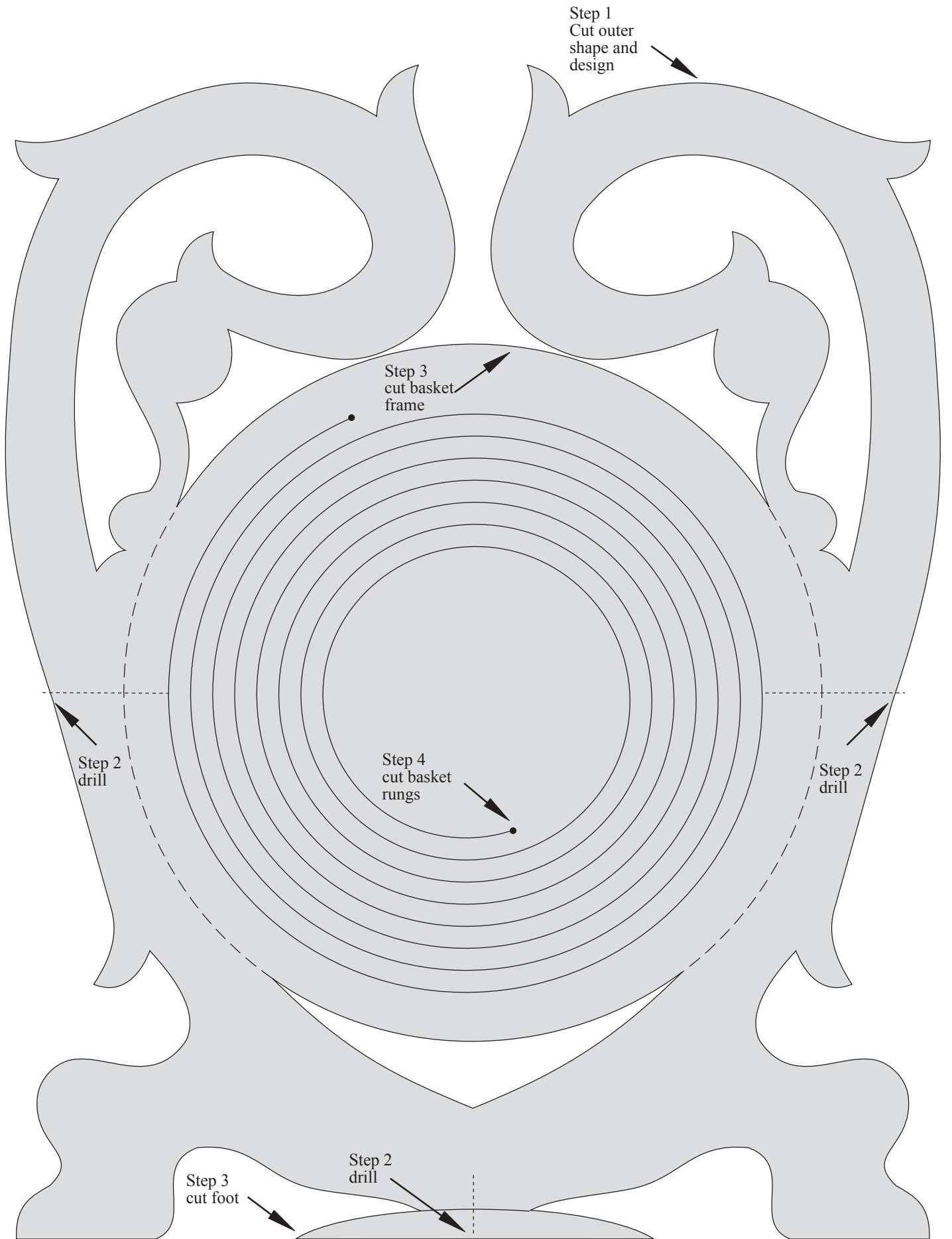

After cutting, route both sides of the dashed line with a corner round bit, routing deeper at the pivot points if necessary. This will allow the basket to open out fully and pivot more freely.

Step 1
Cut outer
shape and
design

Optional:
remove
LUV,
place
numbers
here

Step 3 cut basket frame

Step 2
drill

Step 2
drill

Step 4
cut basket
rungs

Step 3
cut foot

Step 2
drill

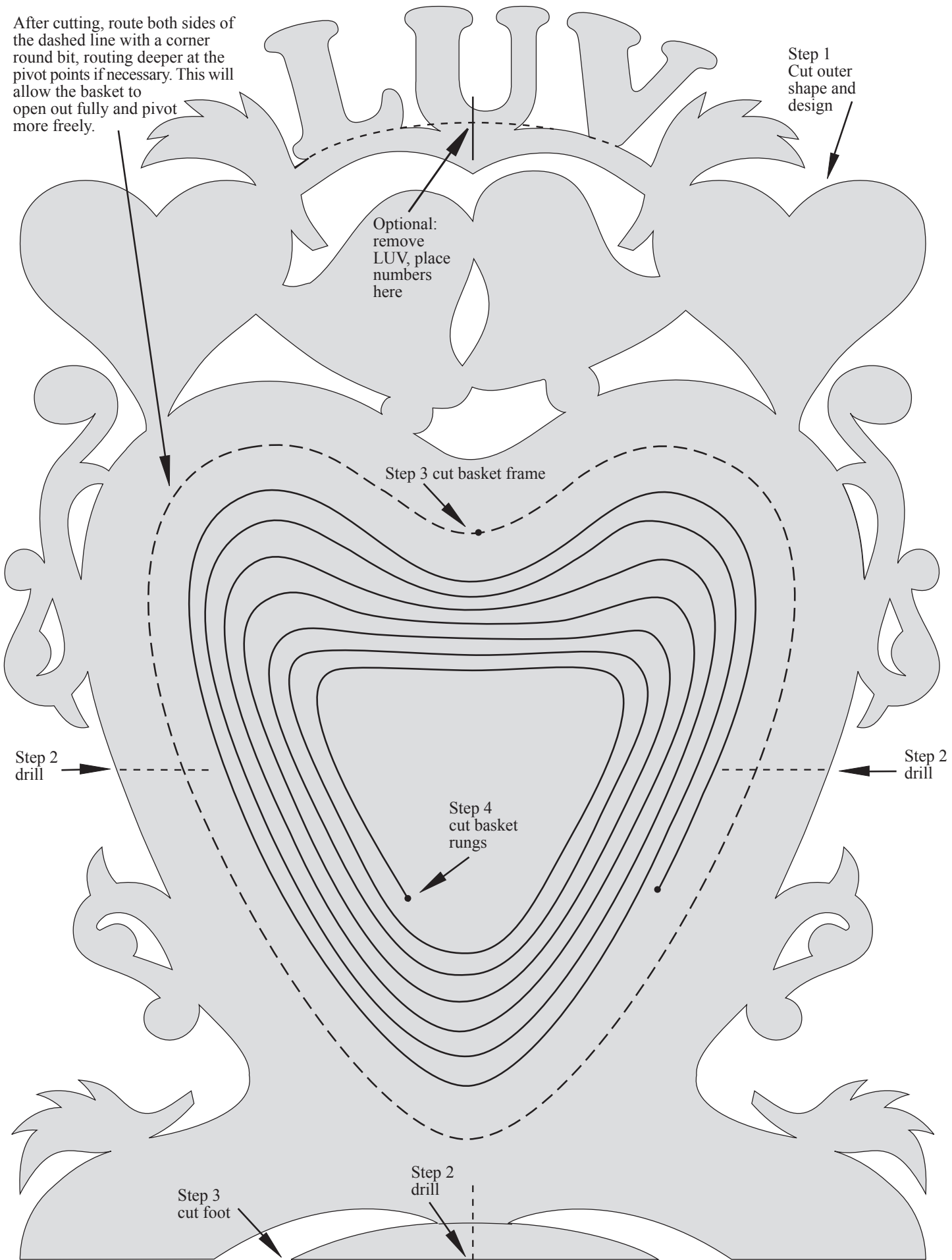

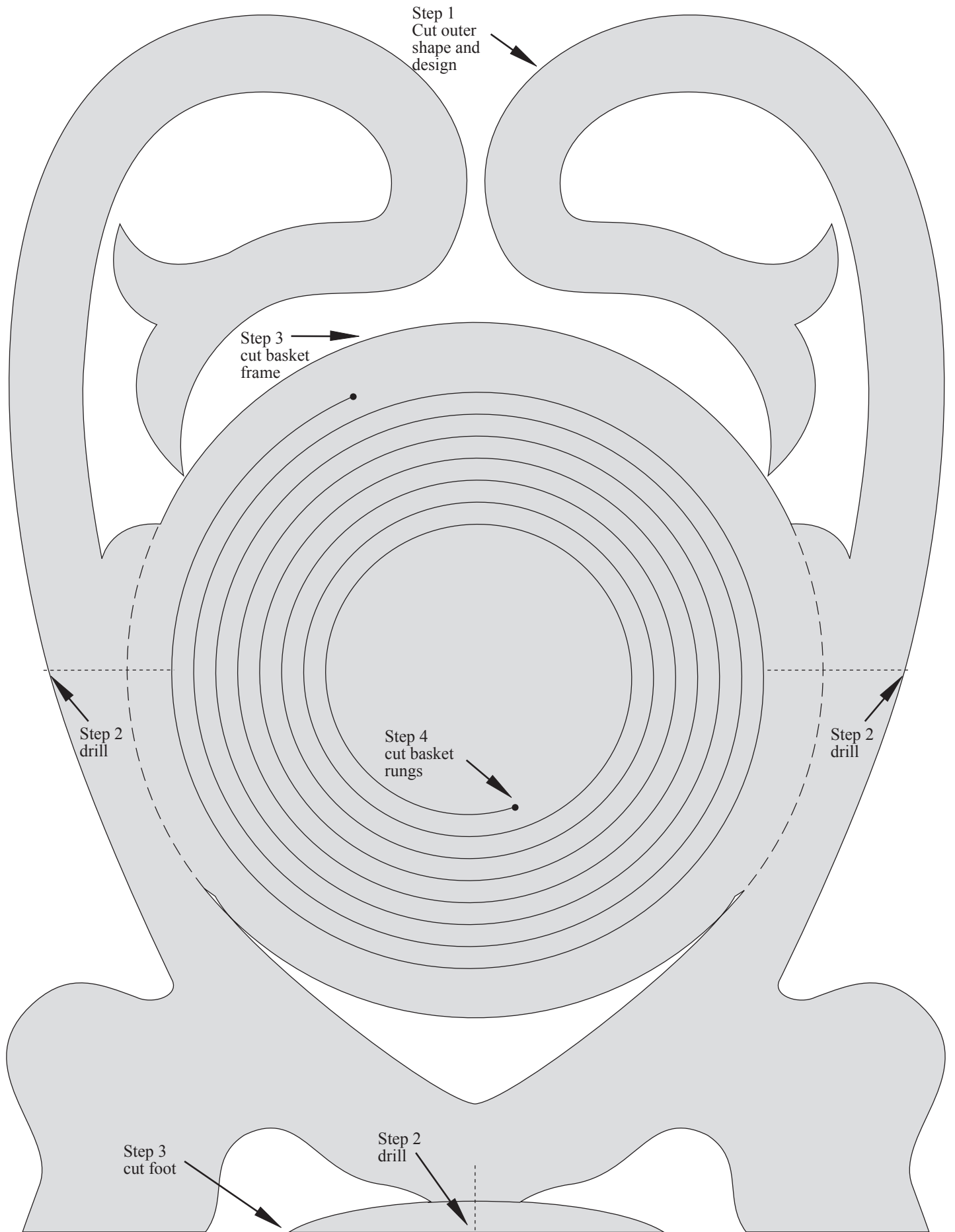

Step 1
Cut outer
shape and
design

Step 3
cut basket
frame

Step 2
drill

Step 4
cut basket
rungs

Step 2
drill

Step 3
cut foot

Step 2
drill

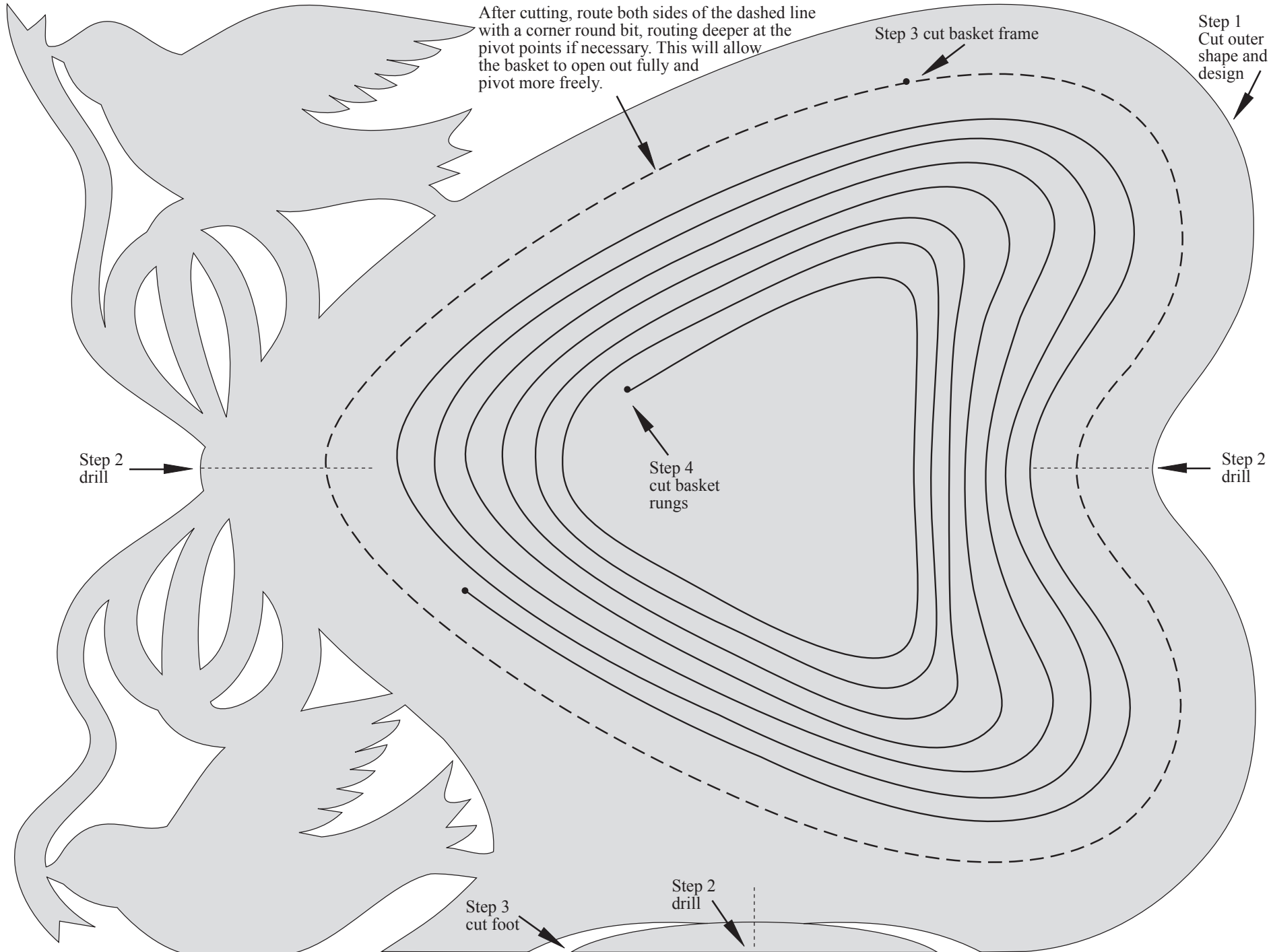

After cutting, route both sides of the dashed line with a corner round bit, routing deeper at the pivot points if necessary. This will allow the basket to open out fully and pivot more freely.

Step 1
Cut outer shape and design

Step 3 cut basket frame

Step 2
drill

Step 2
drill

Step 4
cut basket
rungs

Step 3
cut foot

Step 2
drill

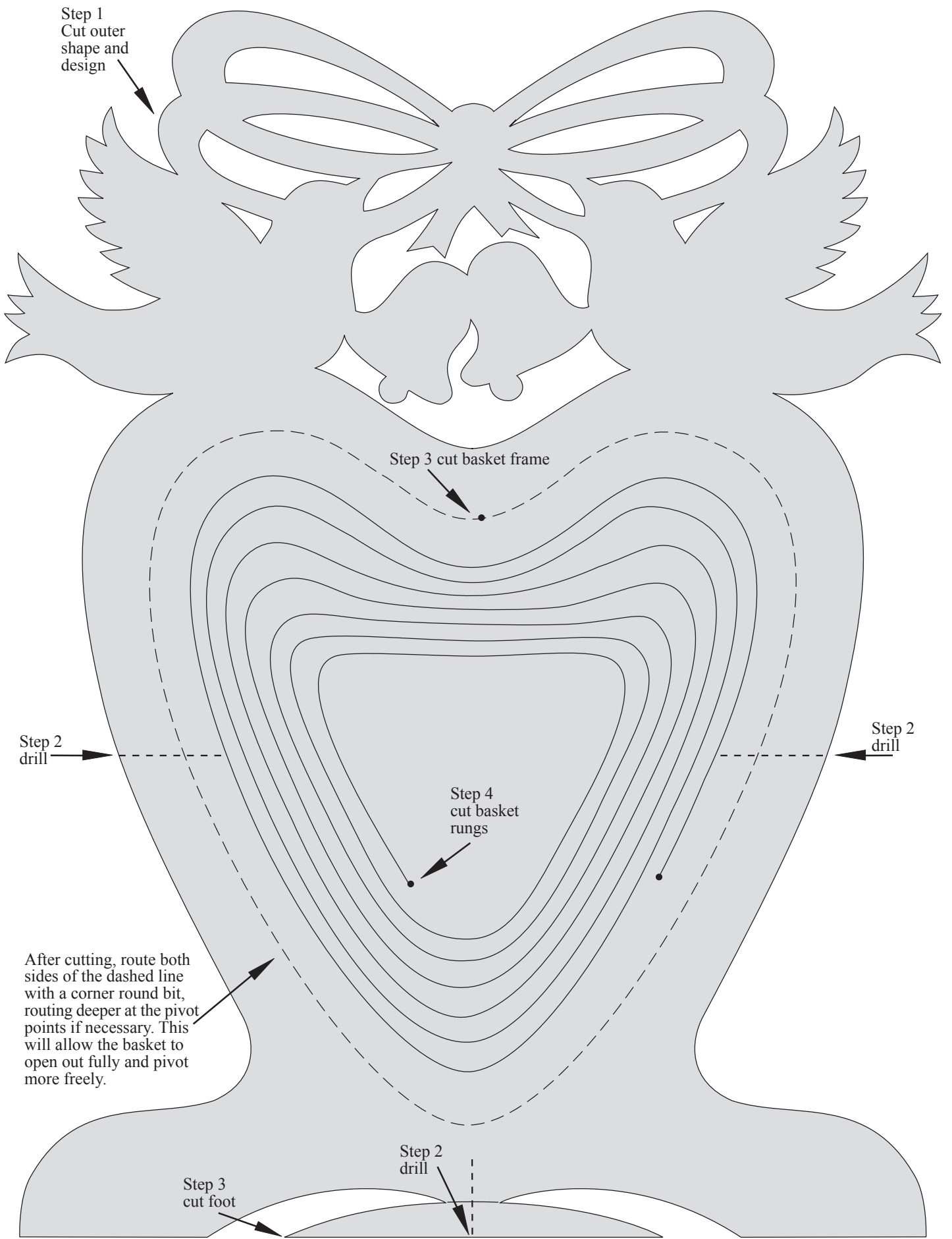

Step 1
Cut outer
shape and
design

Step 3 cut basket frame

Step 2
drill

Step 2
drill

Step 4
cut basket
rungs

After cutting, route both
sides of the dashed line
with a corner round bit,
routing deeper at the pivot
points if necessary. This
will allow the basket to
open out fully and pivot
more freely.

Step 3
cut foot

Step 2
drill

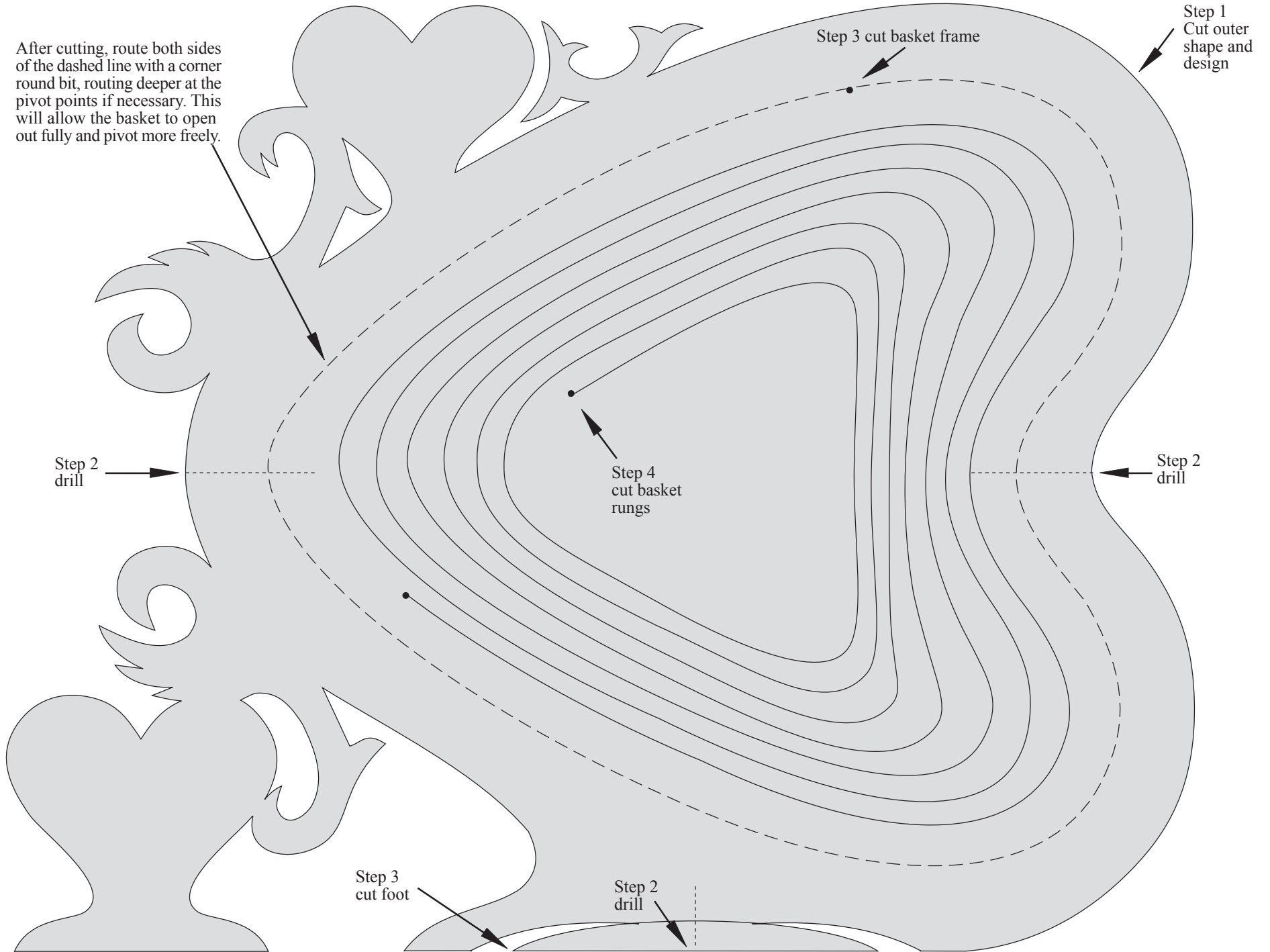

After cutting, route both sides of the dashed line with a corner round bit, routing deeper at the pivot points if necessary. This will allow the basket to open out fully and pivot more

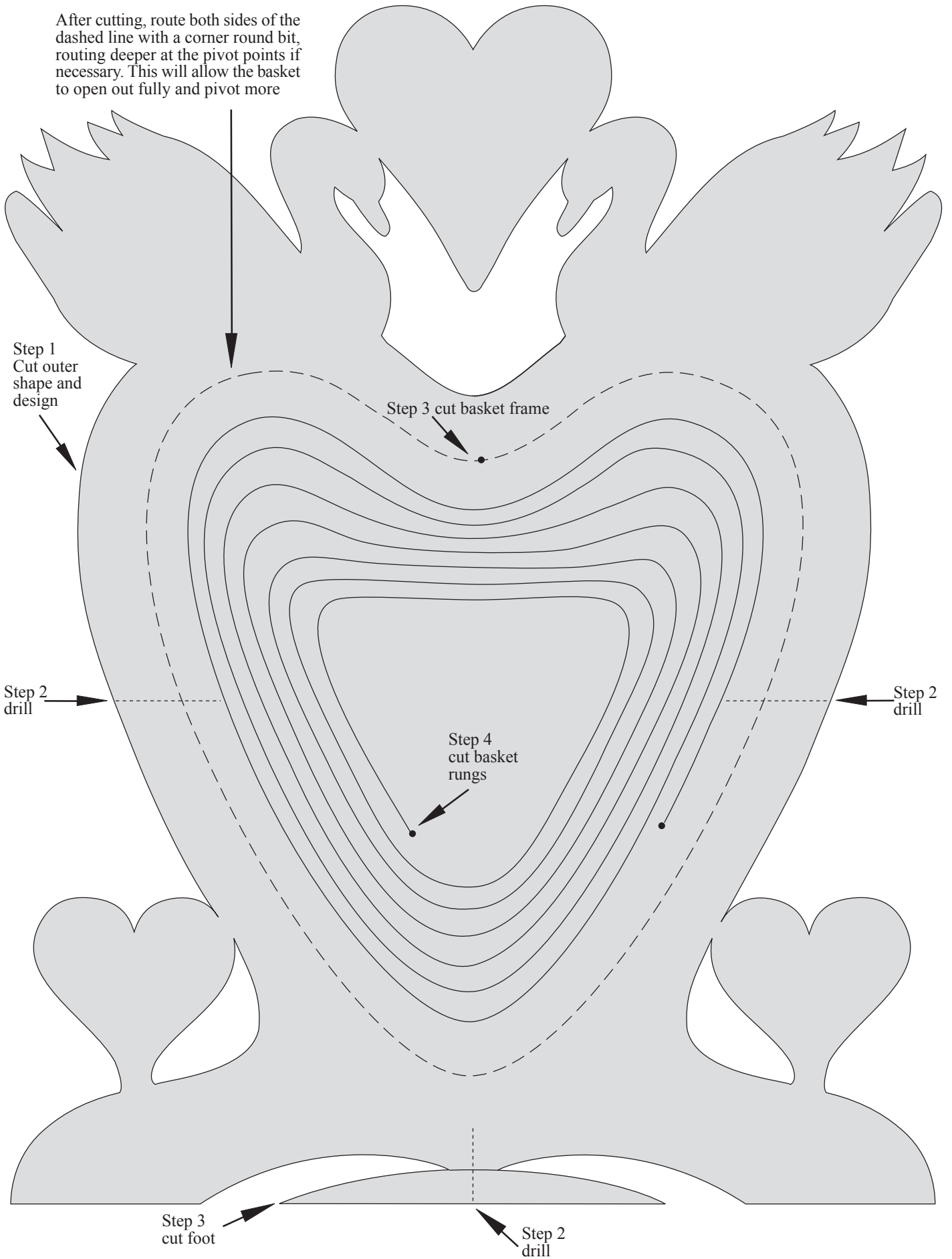

Step 1
Cut outer
shape and
design



Step 3 cut basket frame



Step 2
drill



Step 2
drill



Step 4
cut basket
rungs



Step 3
cut foot



Step 2
drill

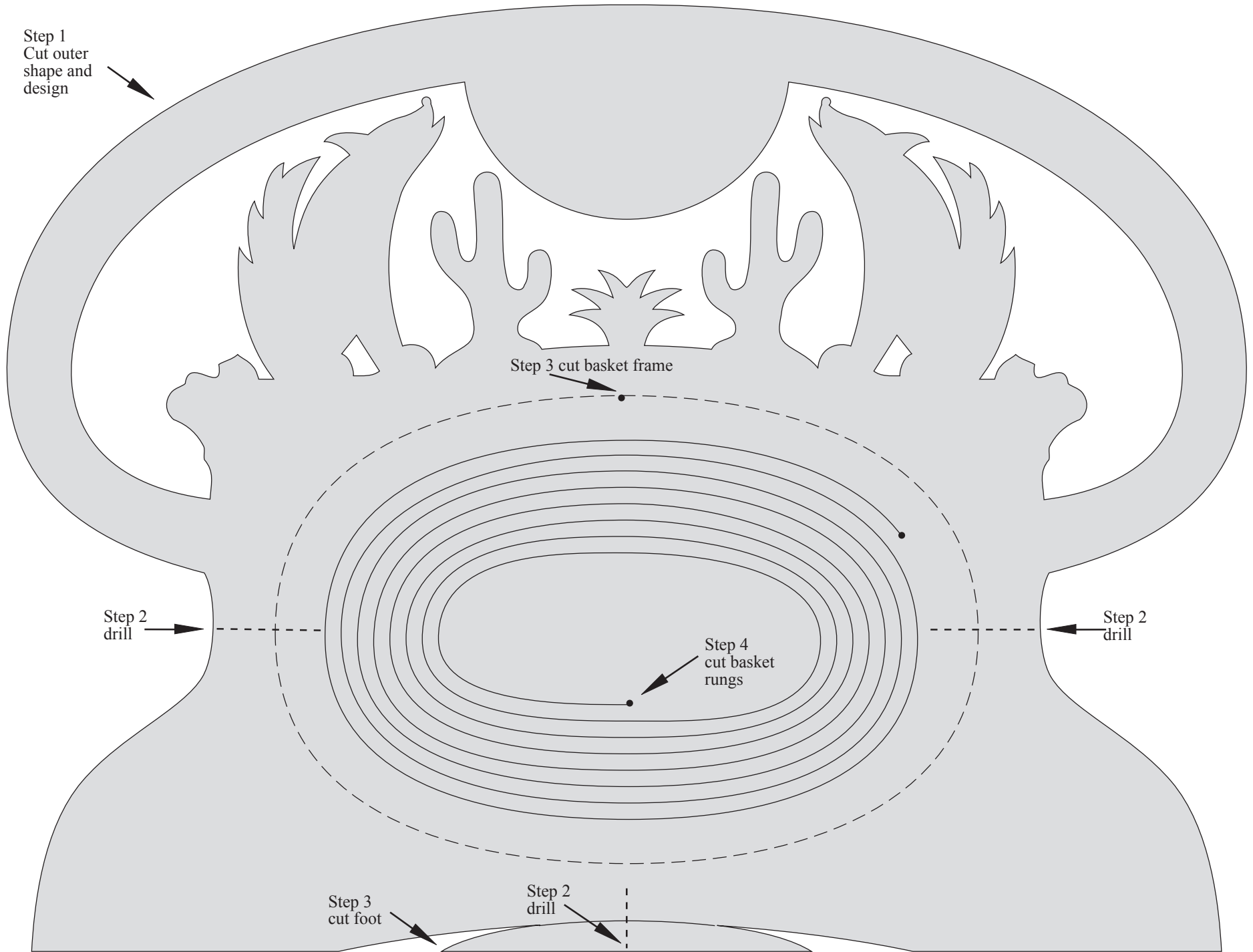

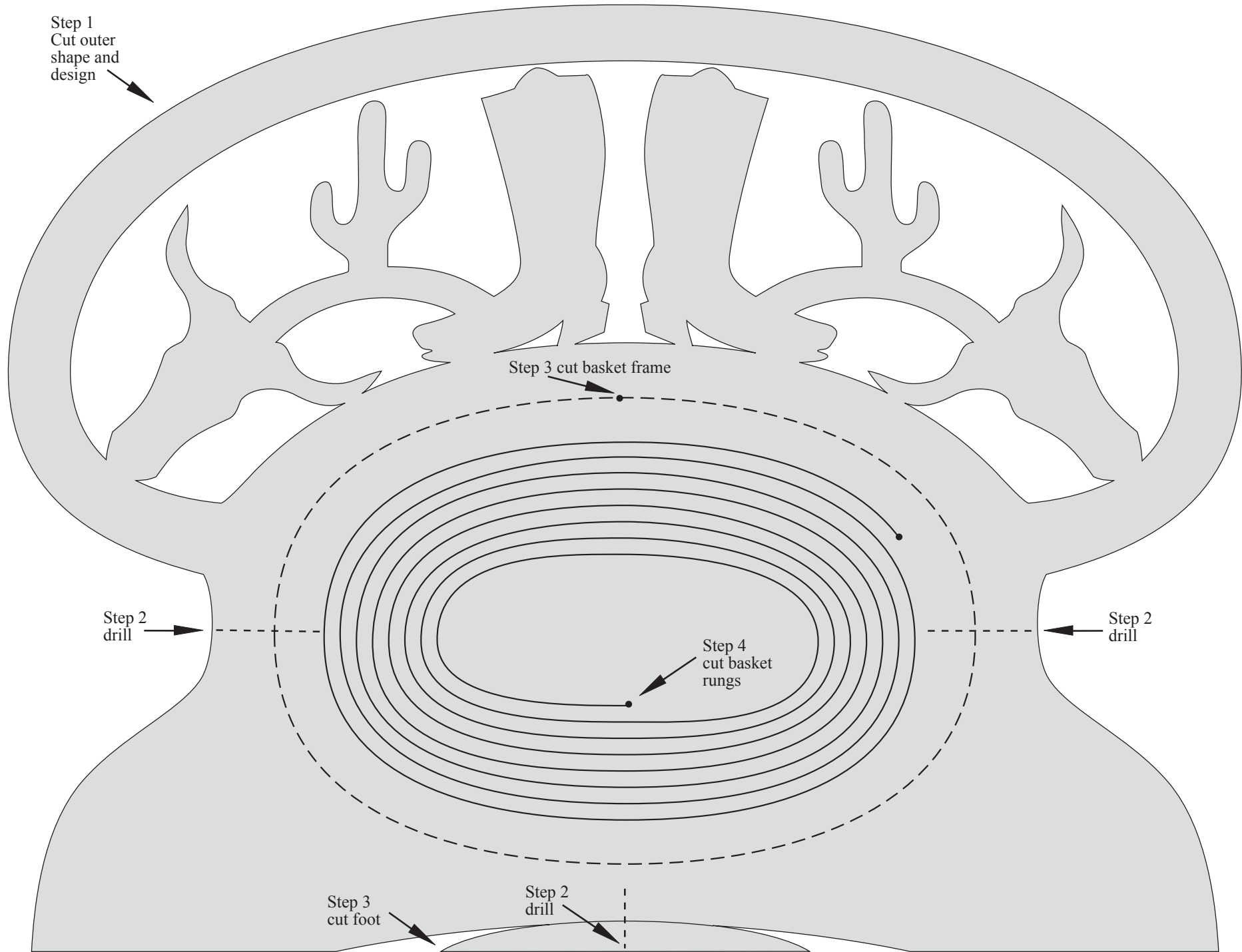

Step 1
Cut outer
shape and
design

Step 3 cut basket frame

Step 2
drill

Step 2
drill

Step 4
cut basket
rungs

Step 3
cut foot

Step 2
drill

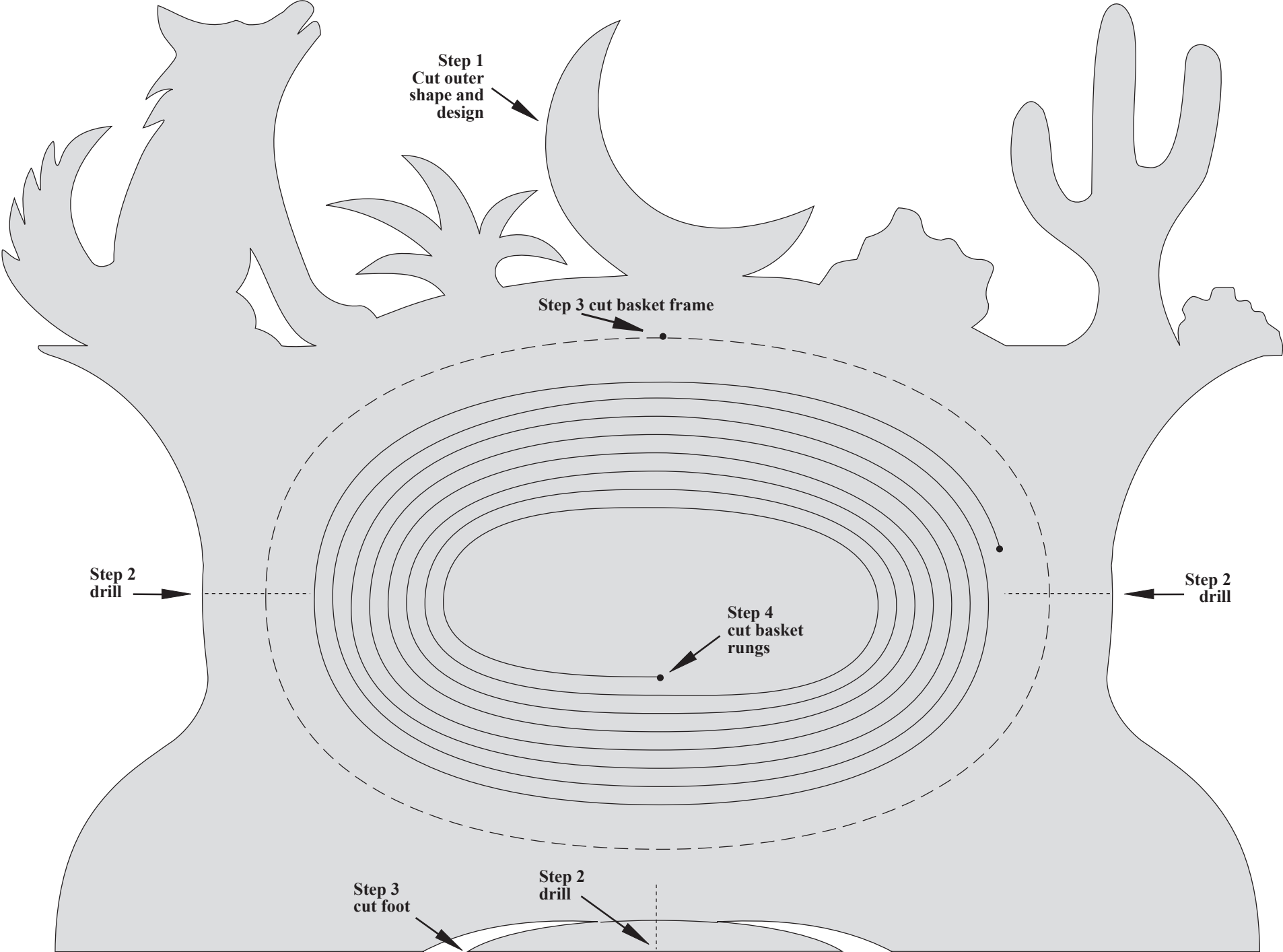

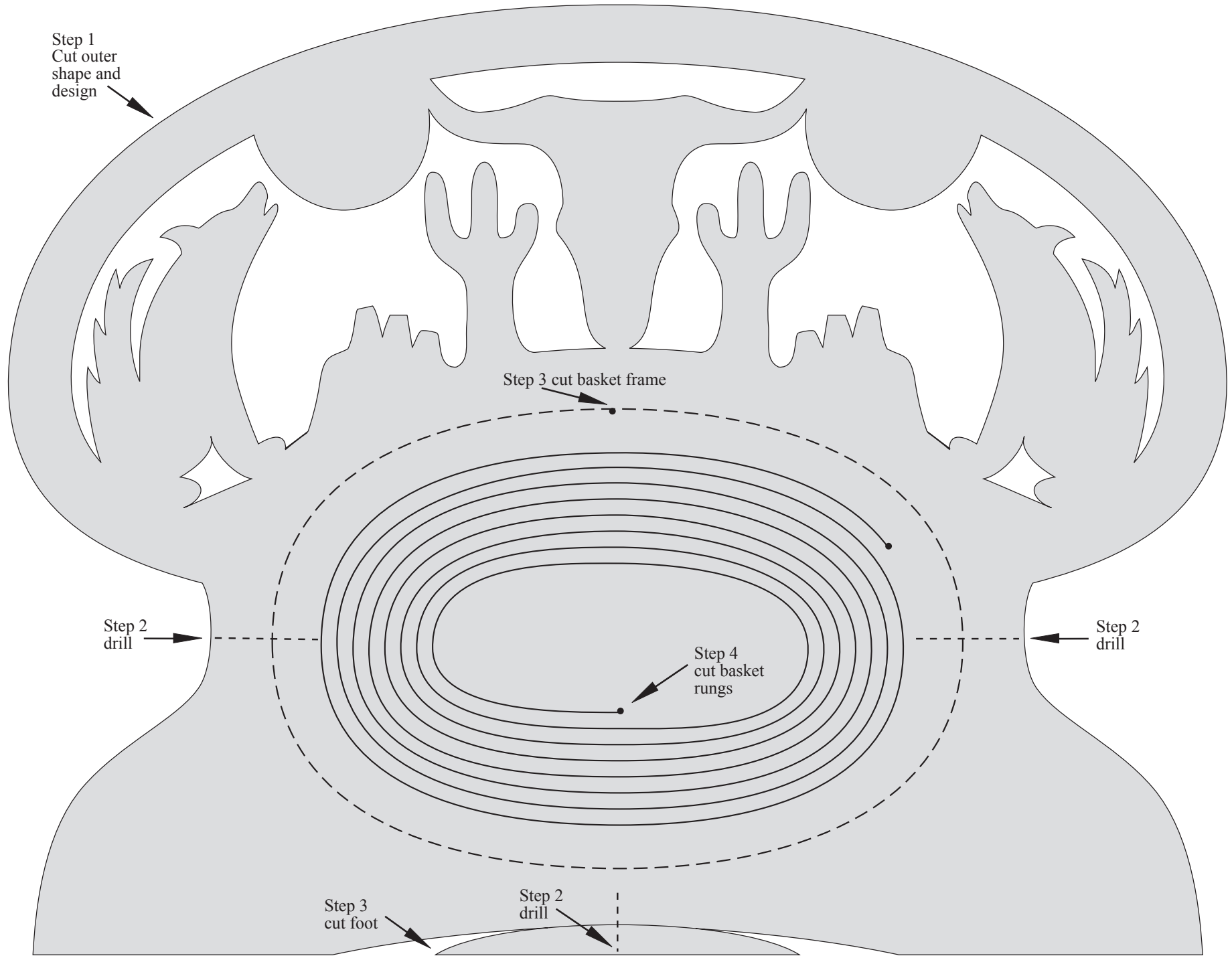

Step 1
Cut outer
shape and
design

Step 3 cut basket frame

Step 2
drill

Step 2
drill

Step 4
cut basket
rungs

Step 3
cut foot

Step 2
drill

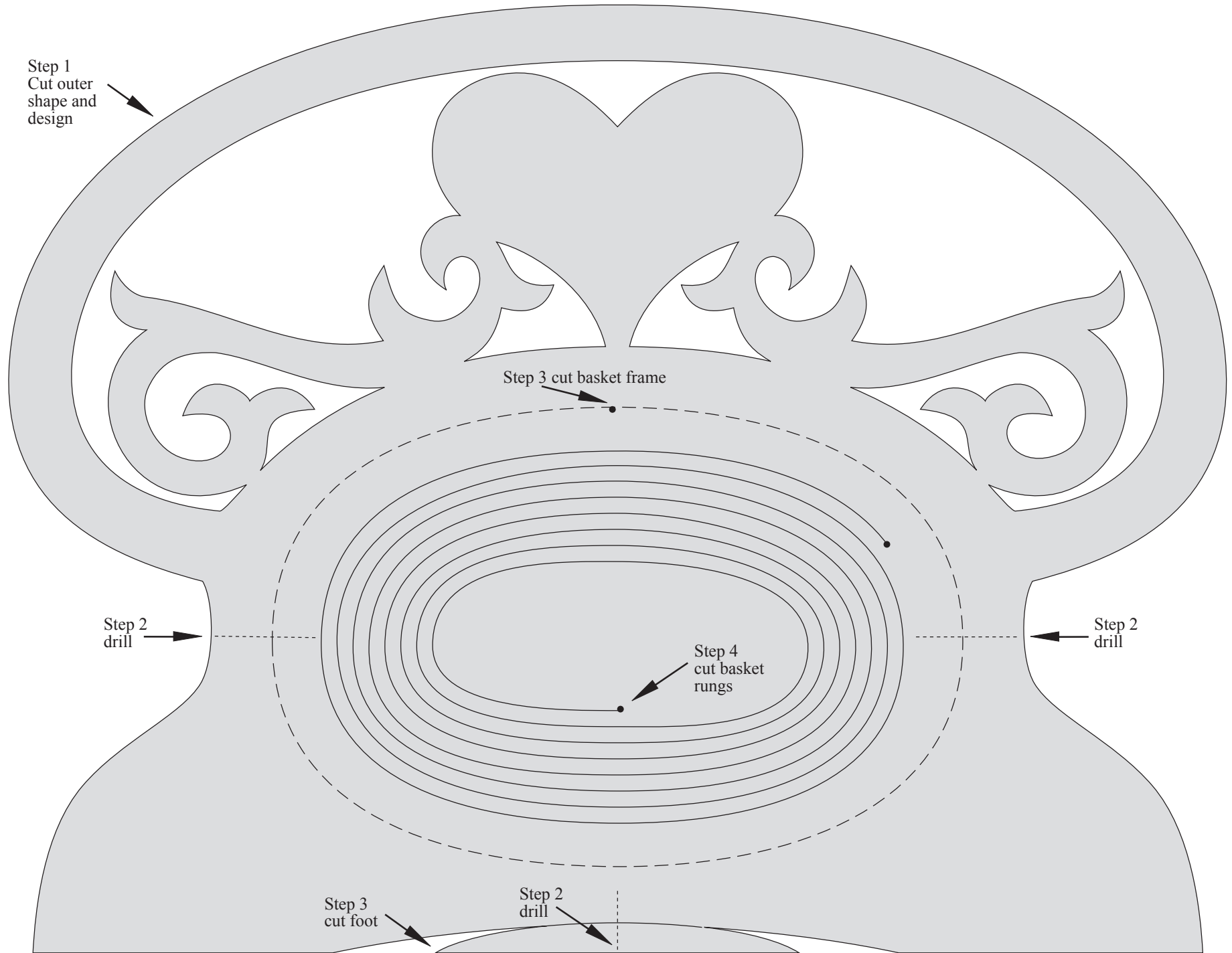

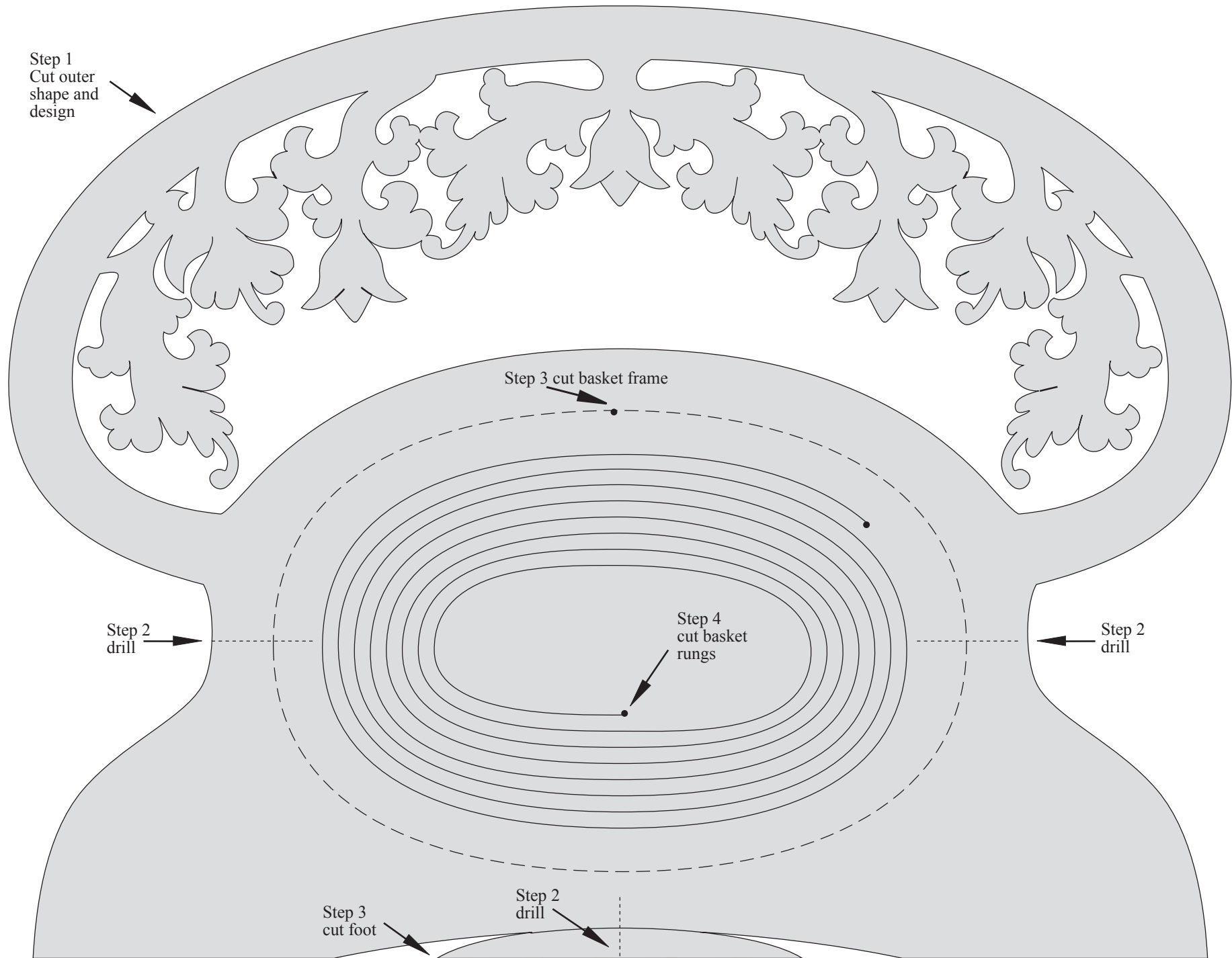

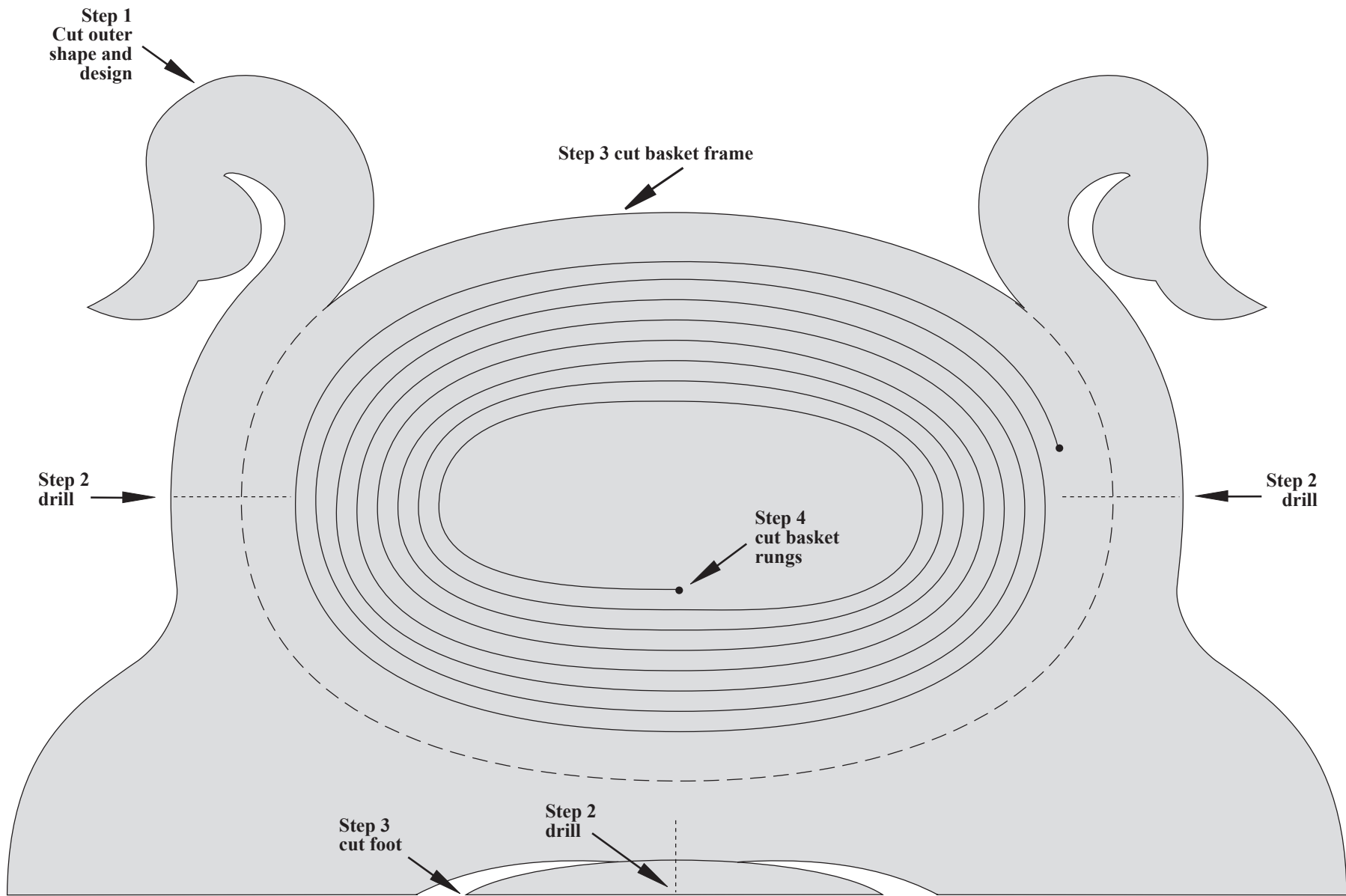

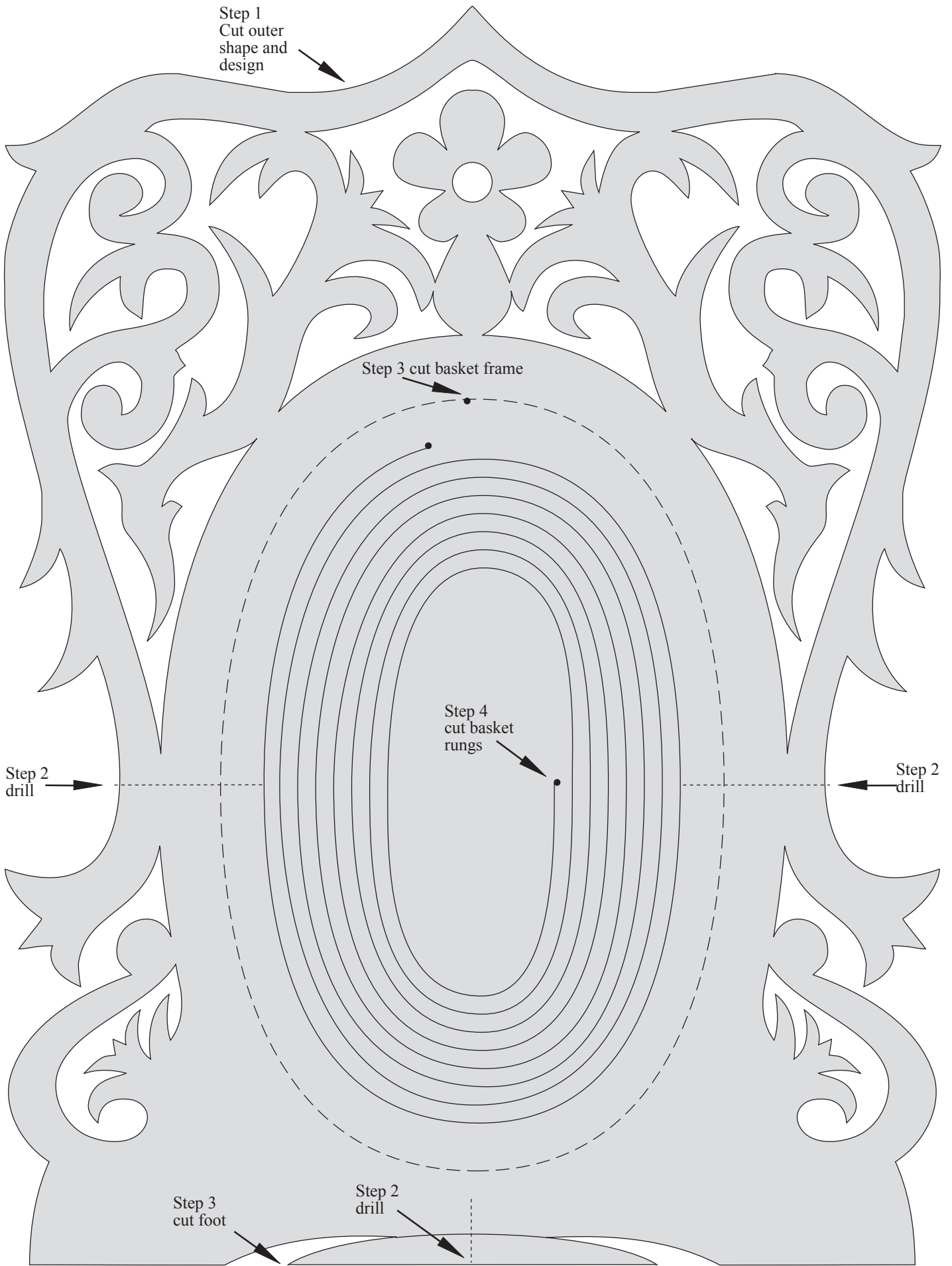

Step 1
Cut outer
shape and
design

Step 3 cut basket frame

Step 4
cut basket
rungs

Step 2
drill

Step 2
drill

Step 3
cut foot

Step 2
drill

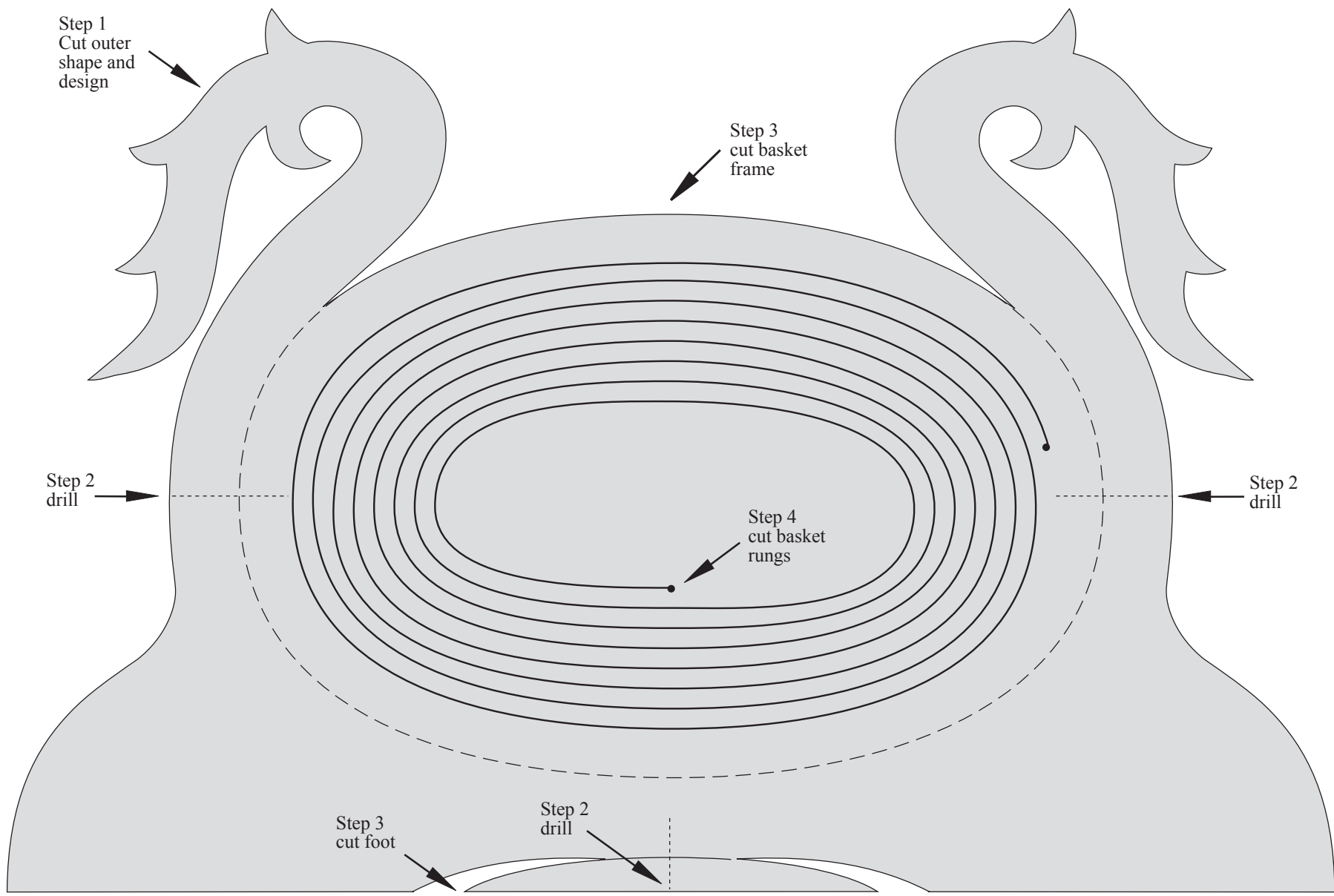

Step 1
Cut outer
shape and
design

Step 3
cut basket
frame

Step 2
drill

Step 2
drill

Step 4
cut basket
rungs

Step 3
cut foot

Step 2
drill

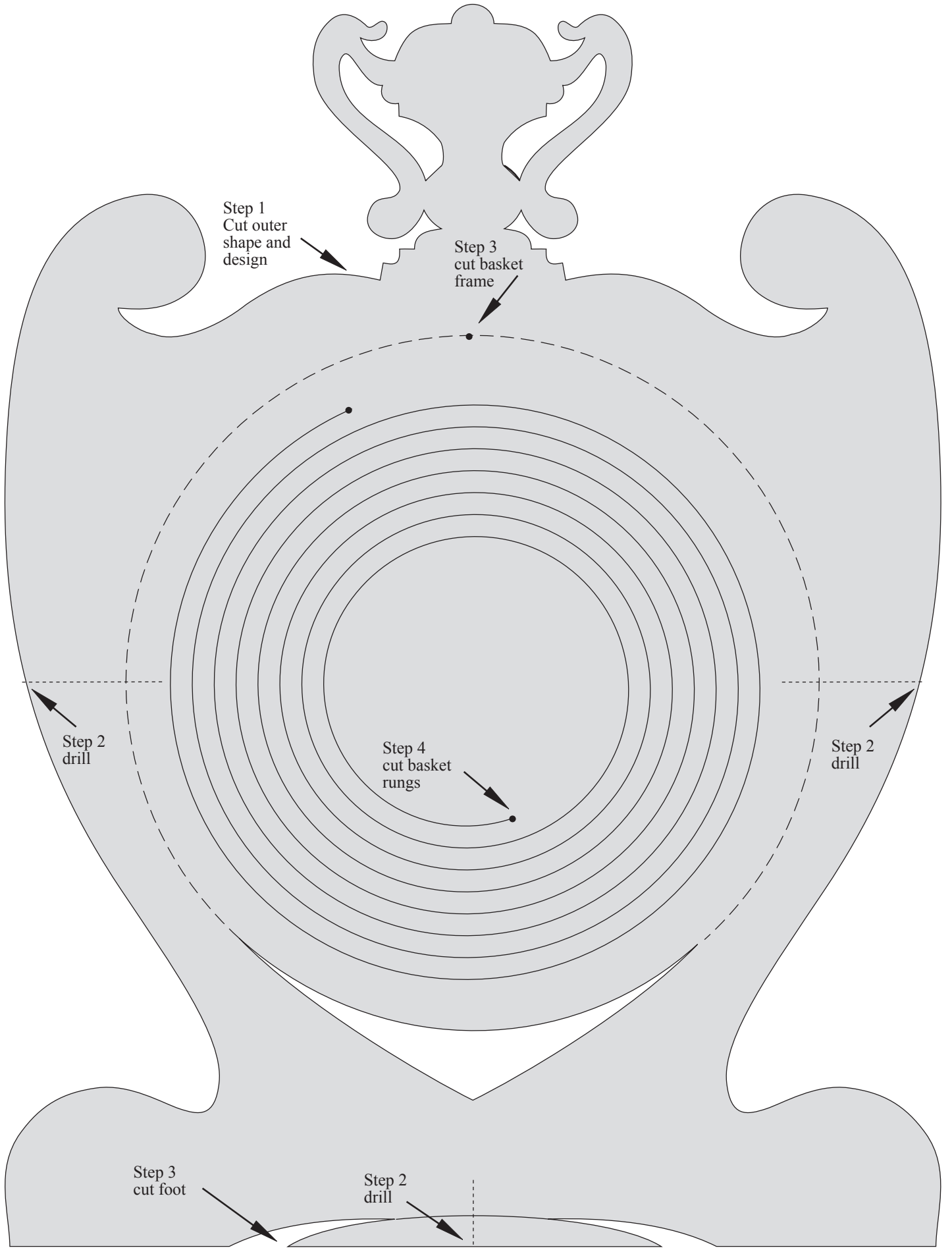

Step 1
Cut outer
shape and
design

Step 3
cut basket
frame

Step 2
drill

Step 2
drill

Step 4
cut basket
rungs

Step 3
cut foot

Step 2
drill

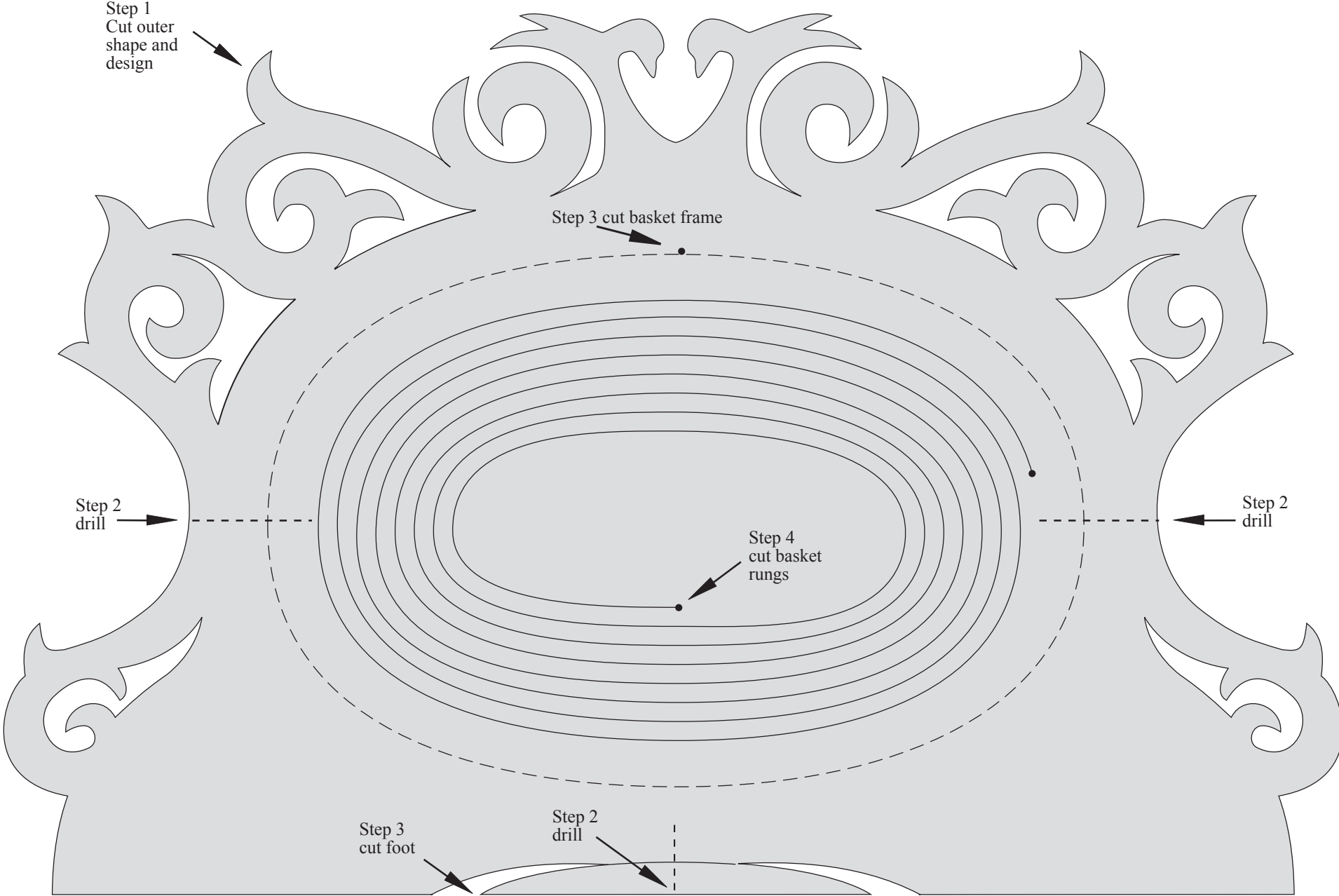

Step 1
Cut outer
shape and
design

Step 3 cut basket frame

Step 2
drill

Step 2
drill

Step 4
cut basket
rungs

Step 3
cut foot

Step 2
drill

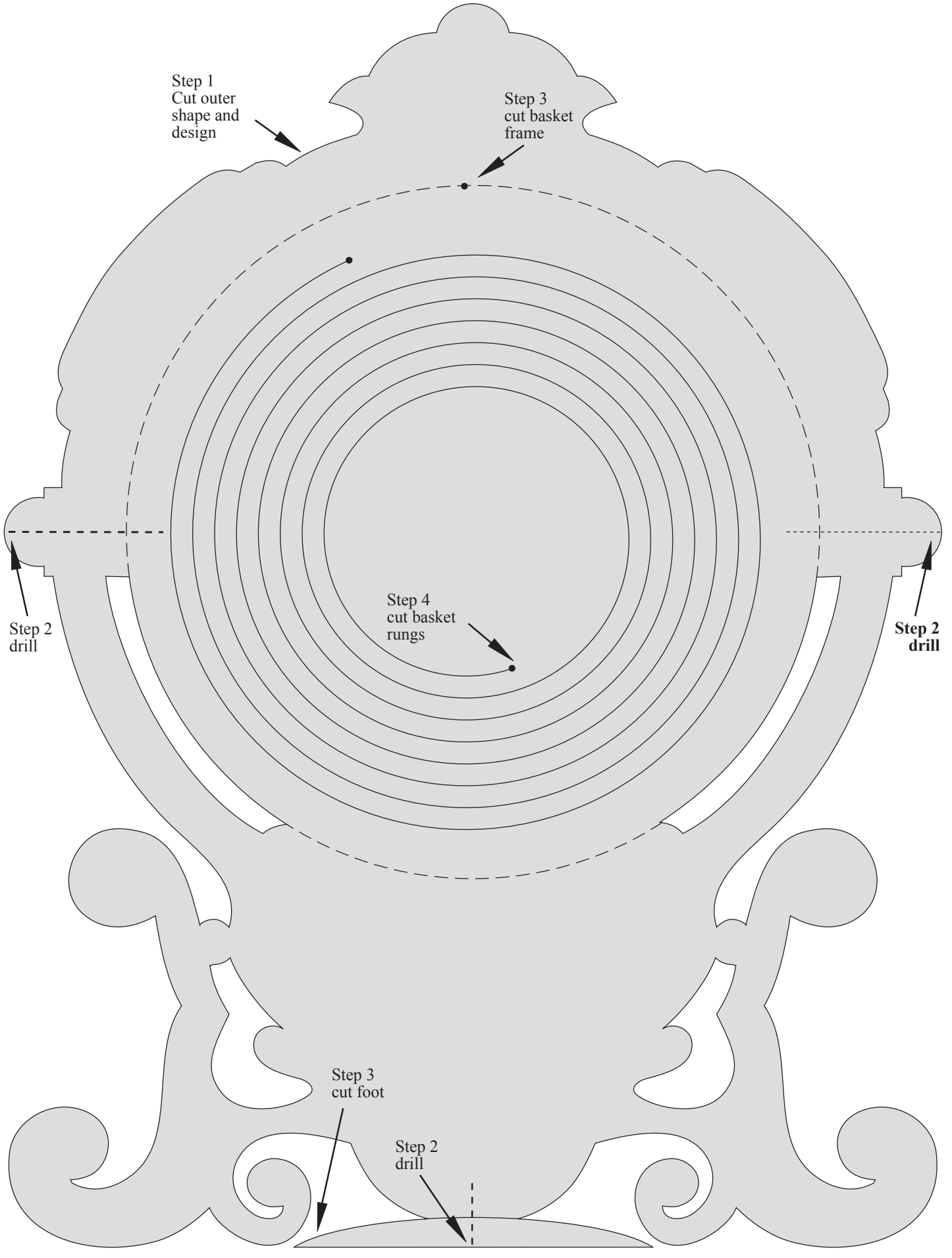

Step 1
Cut outer
shape and
design

Step 3
cut basket
frame

Step 4
cut basket
rungs

Step 2
drill

Step 2
drill

Step 3
cut foot

Step 2
drill

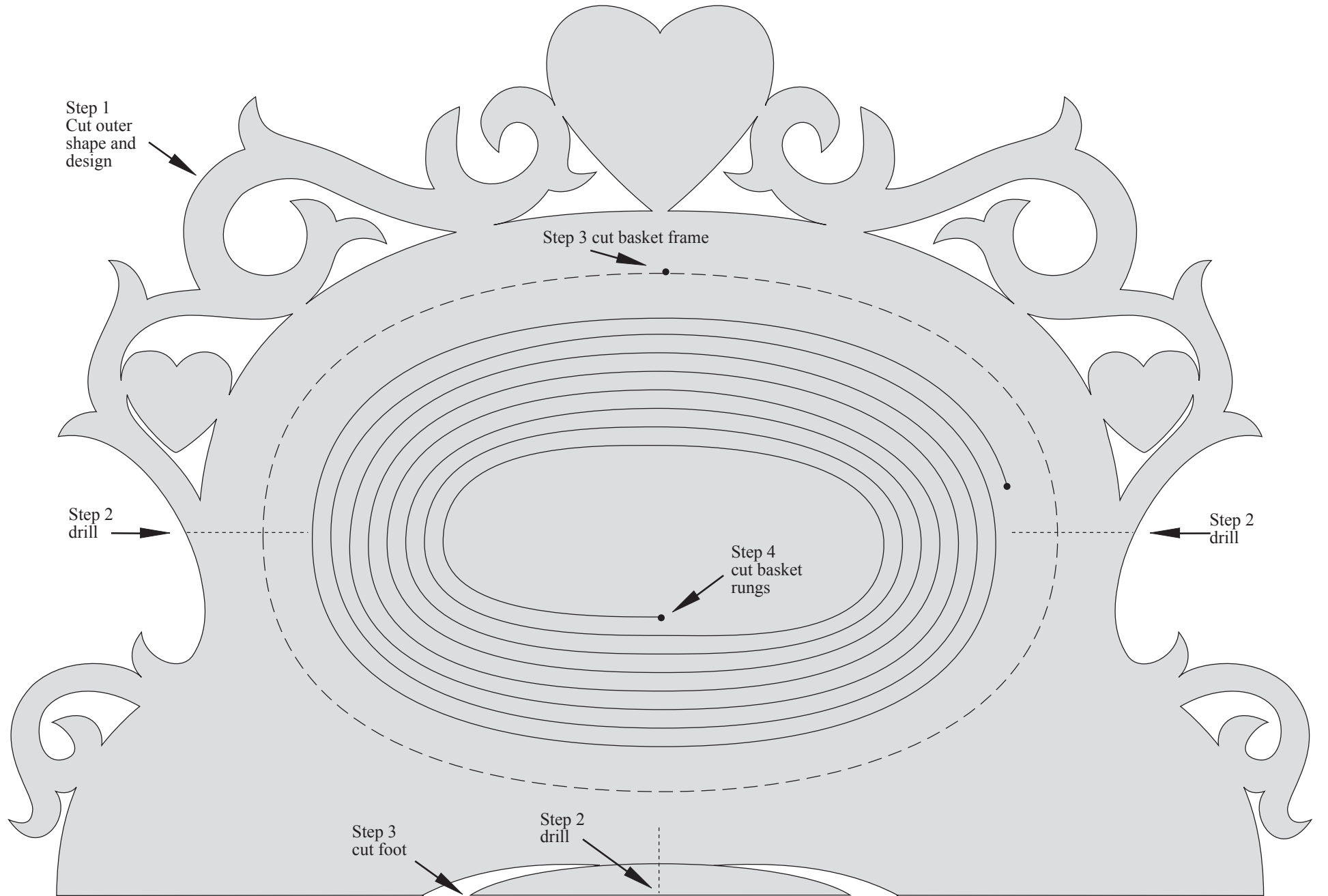

Step 1
Cut outer
shape and
design

Step 3 cut basket frame

Step 2
drill

Step 2
drill

Step 4
cut basket
rungs

Step 3
cut foot

Step 2
drill

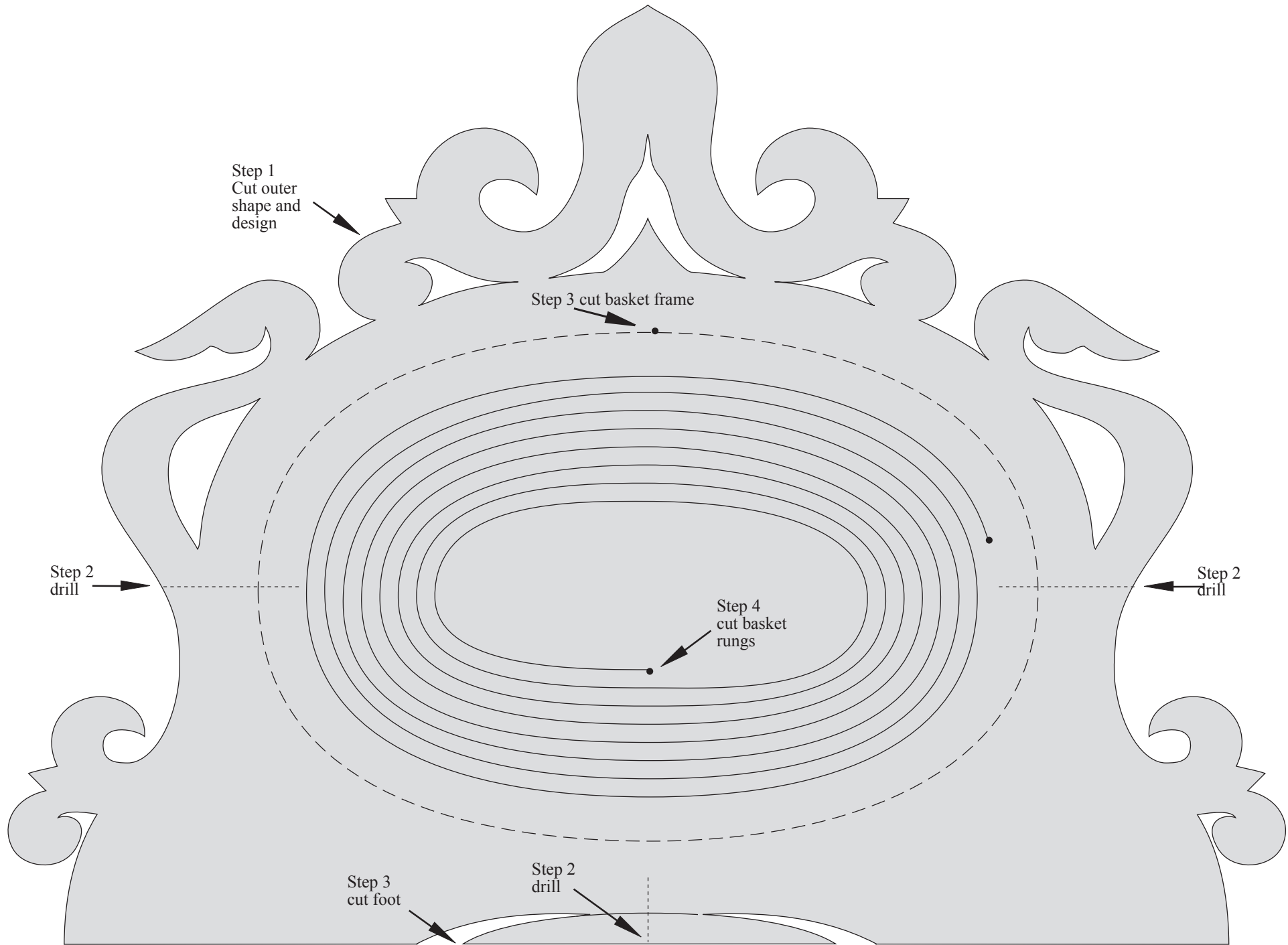

Step 1
Cut outer
shape and
design

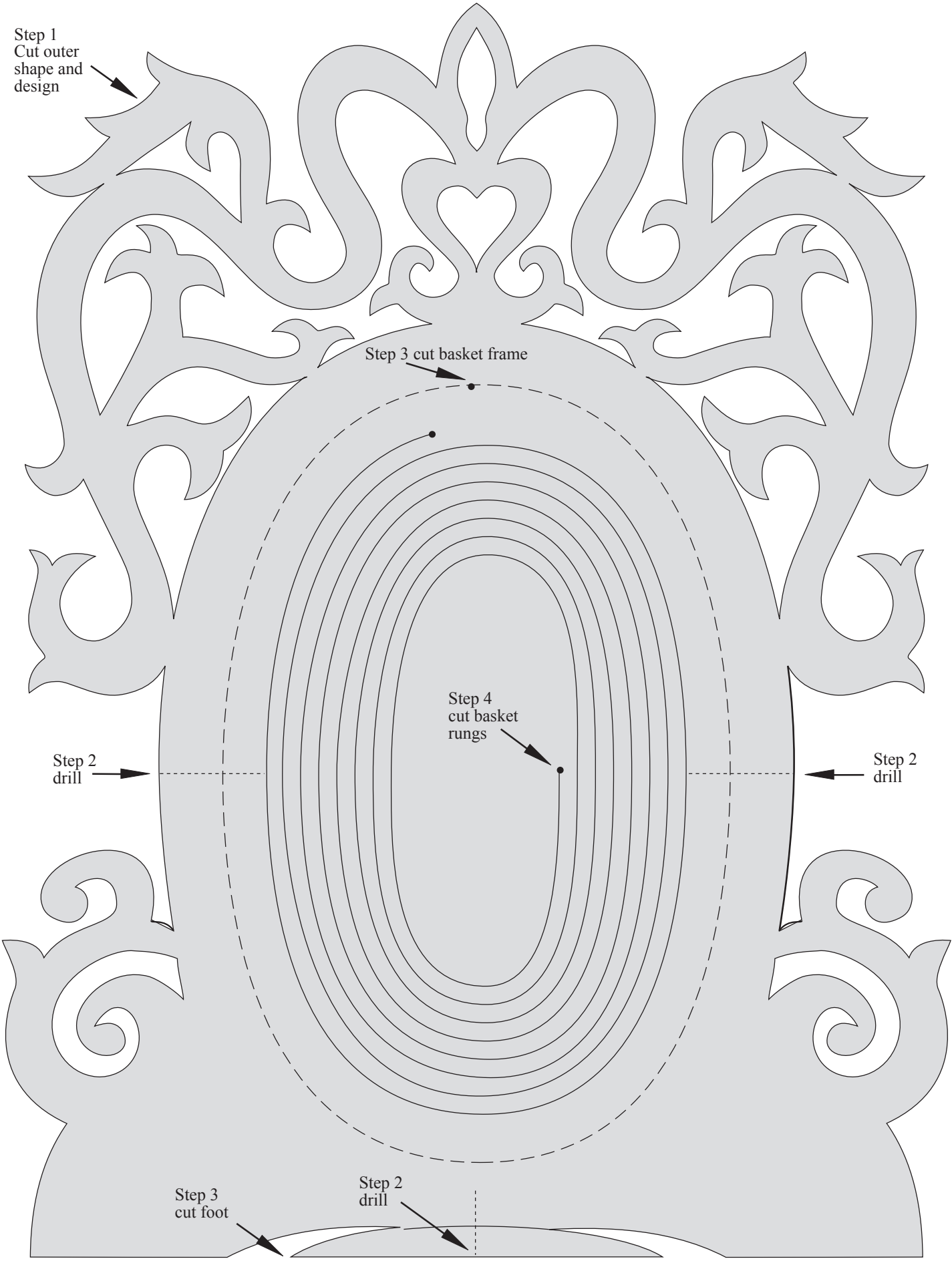

Step 3 cut basket frame

Step 4
cut basket
rungs

Step 2
drill

Step 2
drill

Step 3
cut foot

Step 2
drill

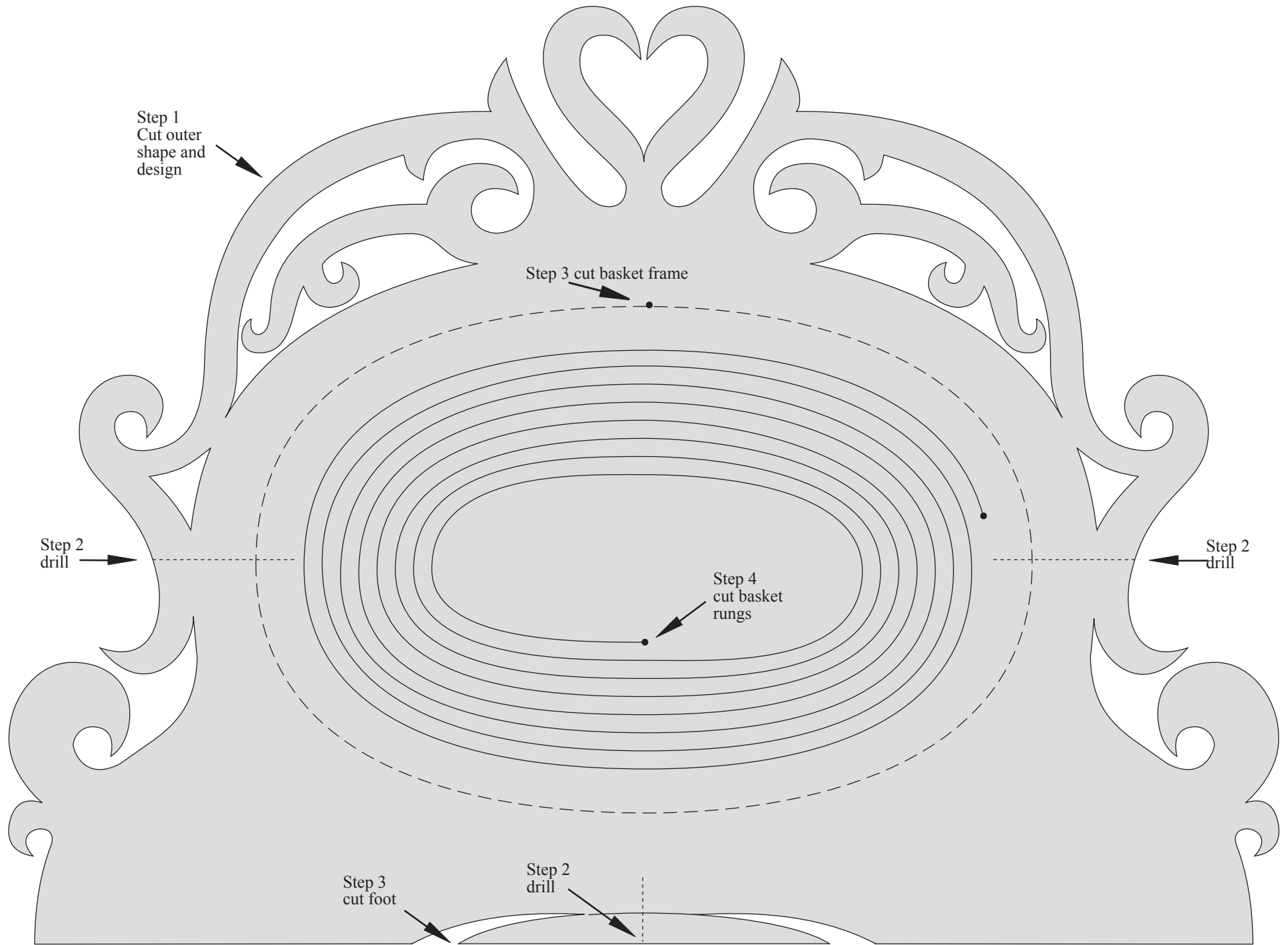

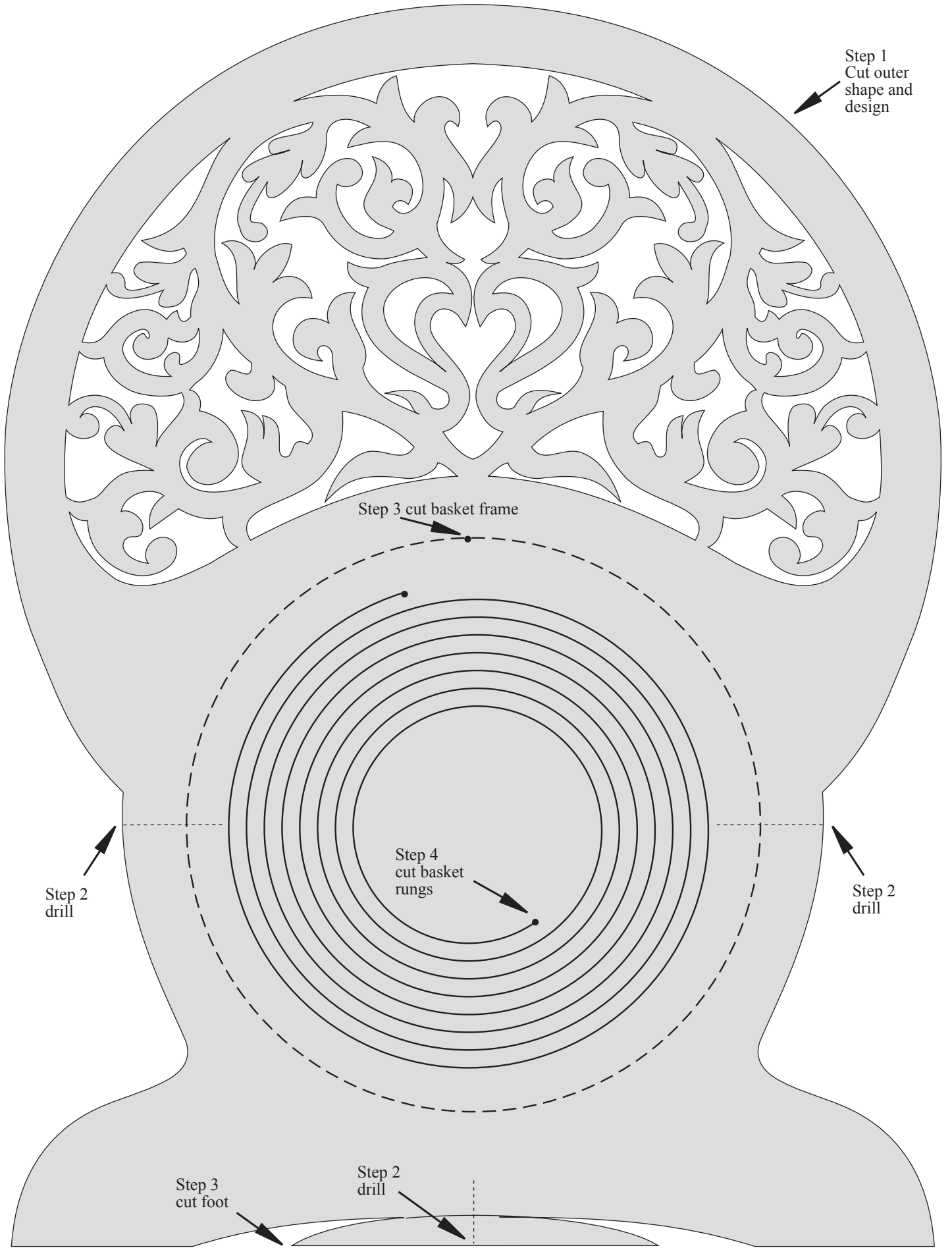

Step 1
Cut outer
shape and
design

Step 3 cut basket frame

Step 4
cut basket
rungs

Step 2
drill

Step 2
drill

Step 3
cut foot

Step 2
drill

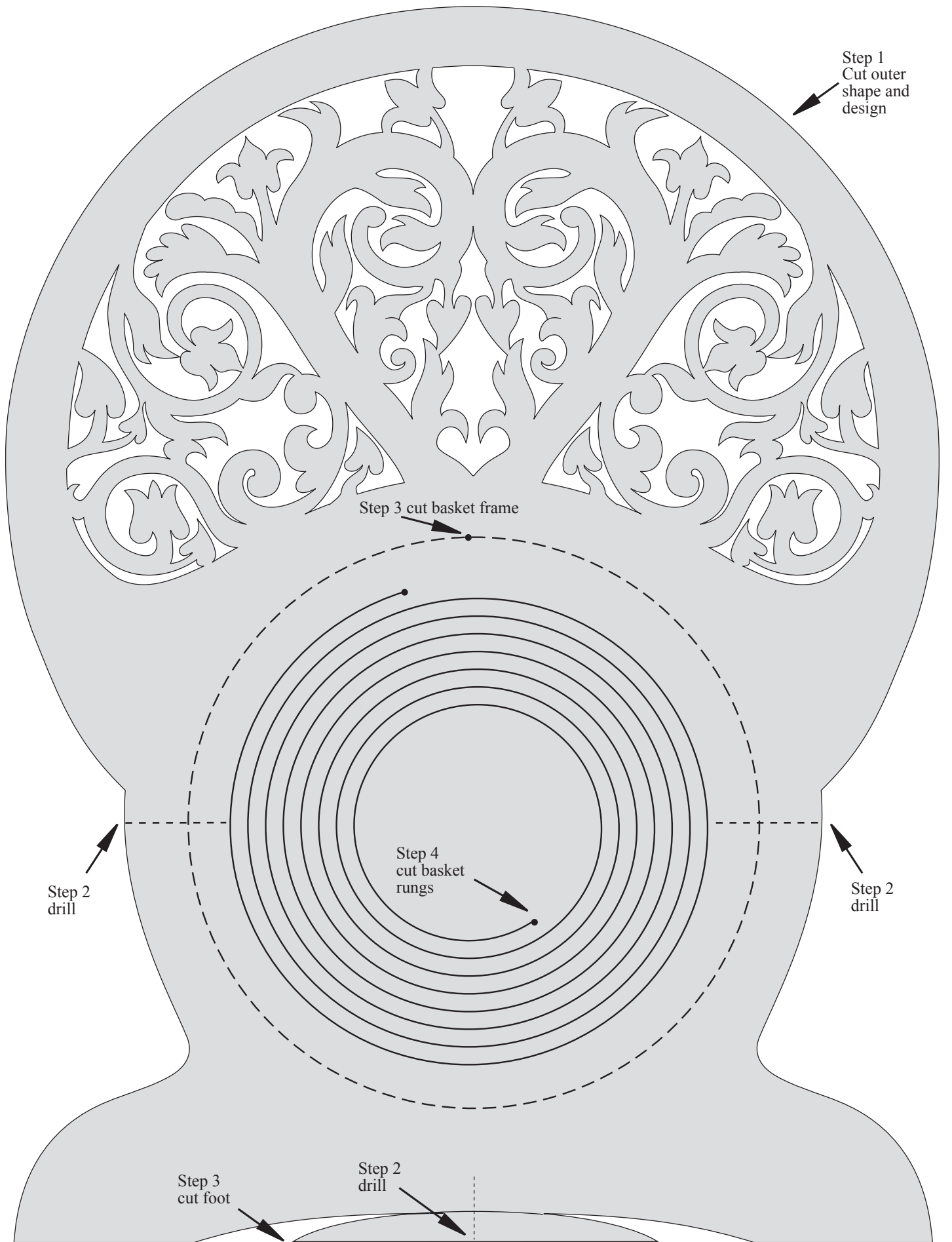

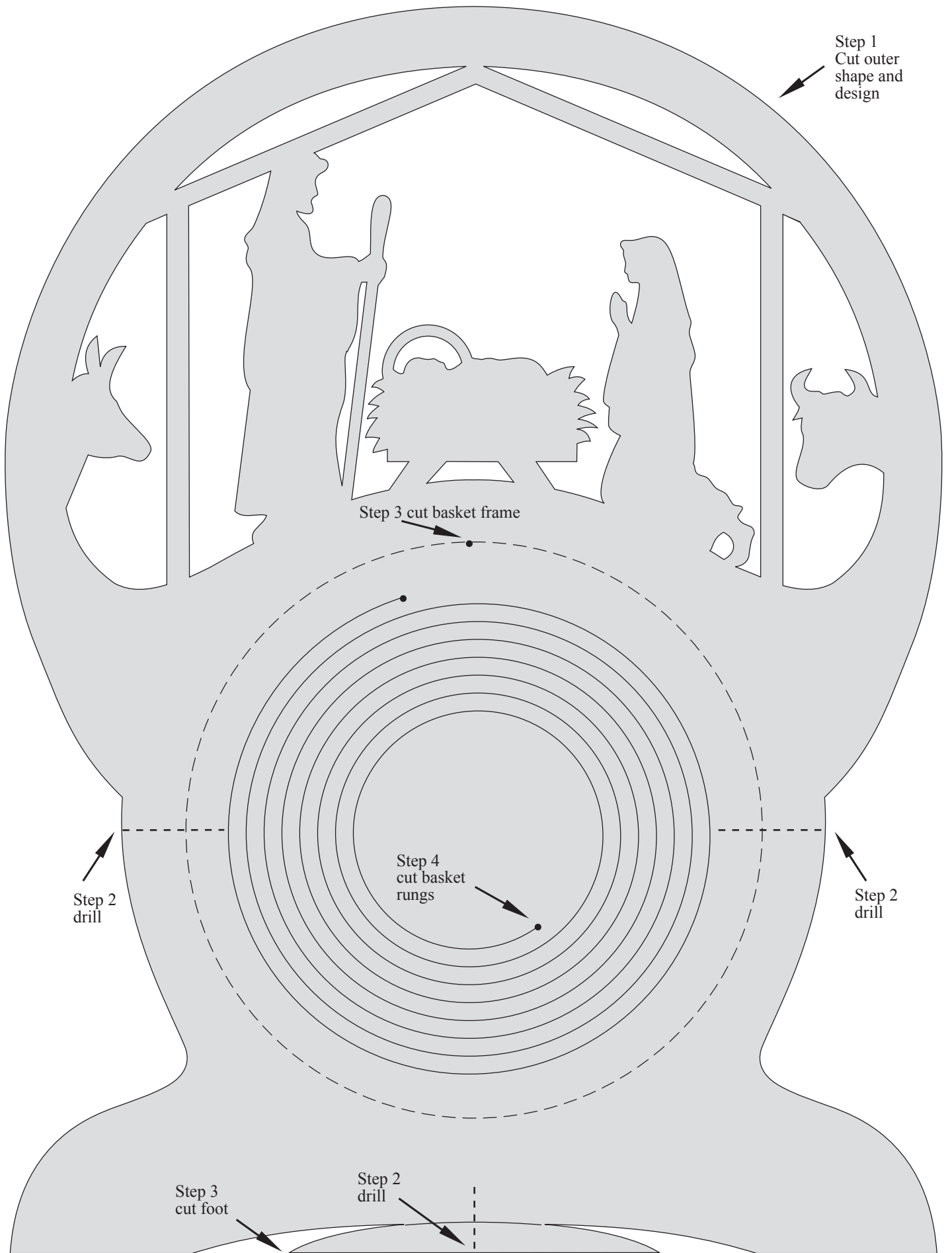

Step 1
Cut outer
shape and
design

Step 3 cut basket frame

Step 2
drill

Step 4
cut basket
rungs

Step 2
drill

Step 3
cut foot

Step 2
drill

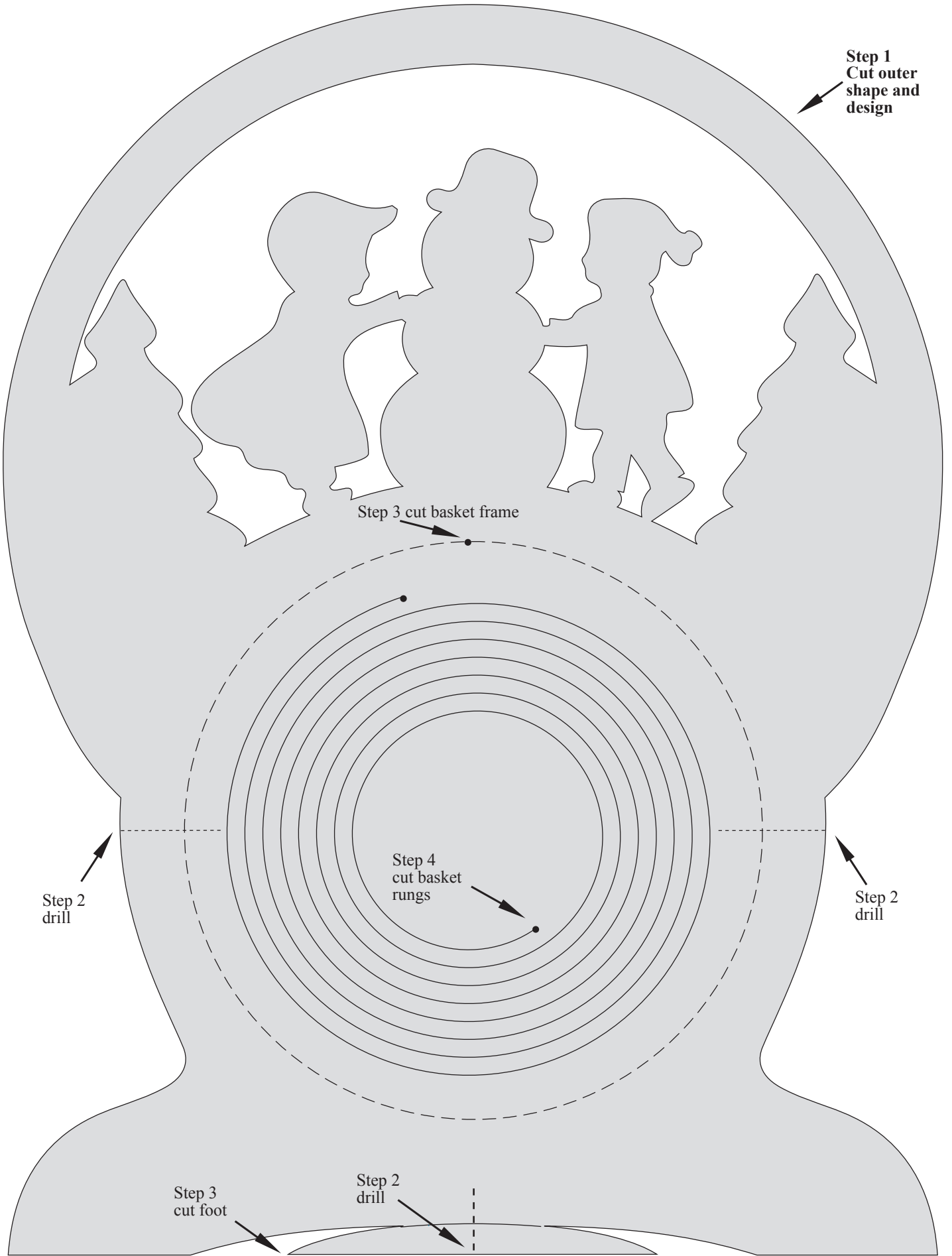

Step 1
Cut outer
shape and
design

Step 3 cut basket frame

Step 4
cut basket
rungs

Step 2
drill

Step 2
drill

Step 3
cut foot

Step 2
drill

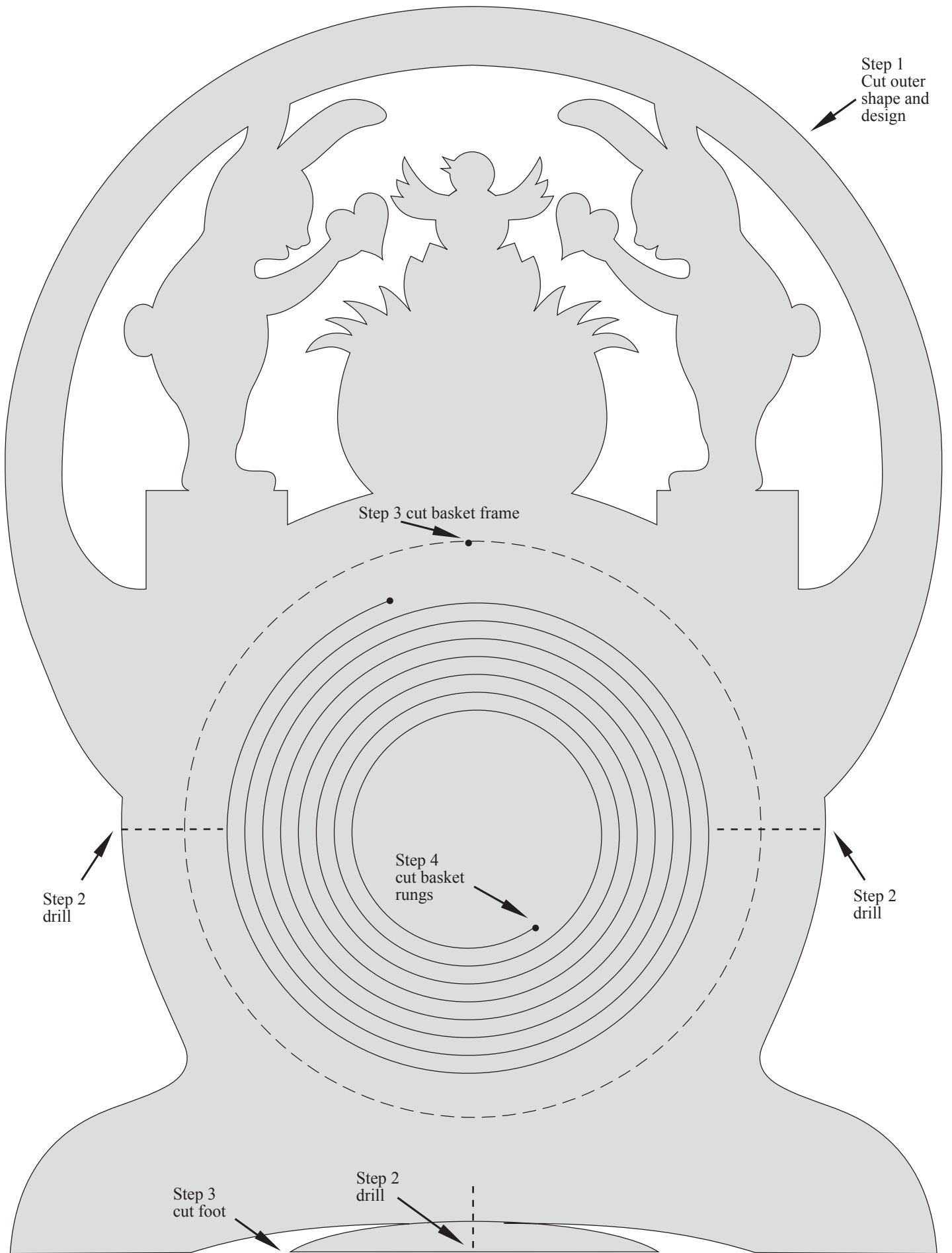

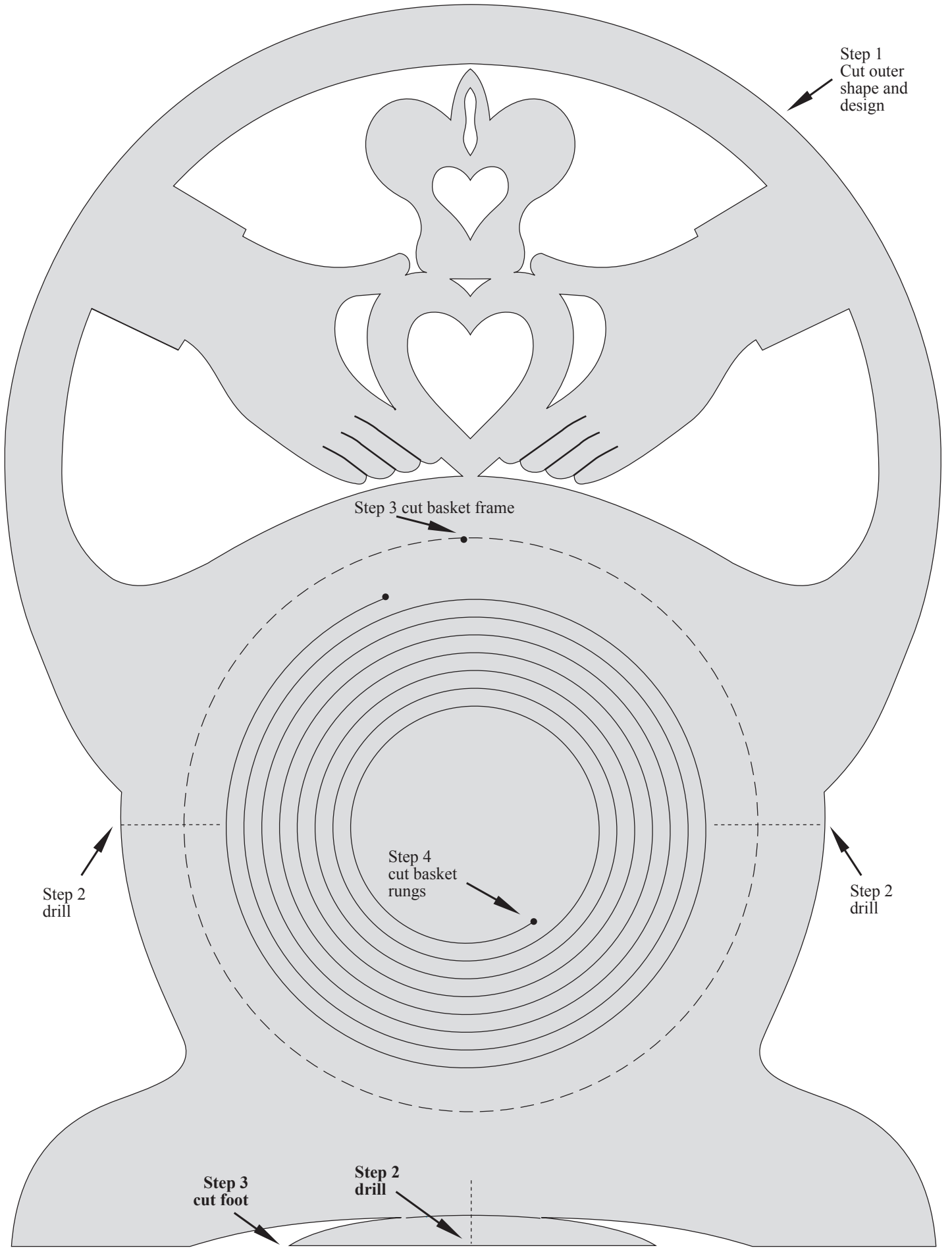

Step 1
Cut outer
shape and
design

Step 3 cut basket frame

Step 2
drill

Step 4
cut basket
rungs

Step 2
drill

Step 3
cut foot

Step 2
drill

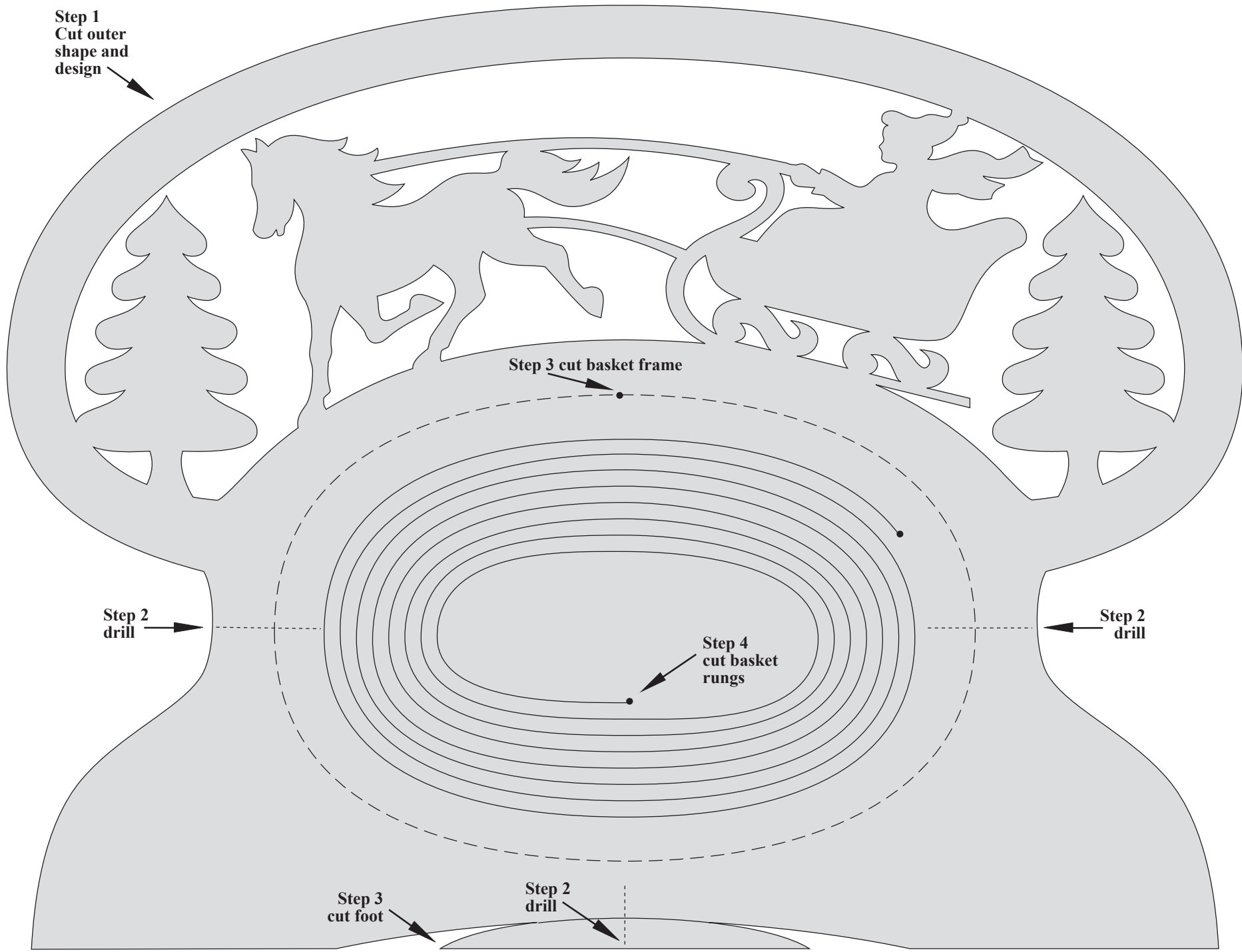

Step 1
Cut outer
shape and
design

Step 3 cut basket frame

Step 2
drill

Step 2
drill

Step 4
cut basket
rungs

Step 3
cut foot

Step 2
drill

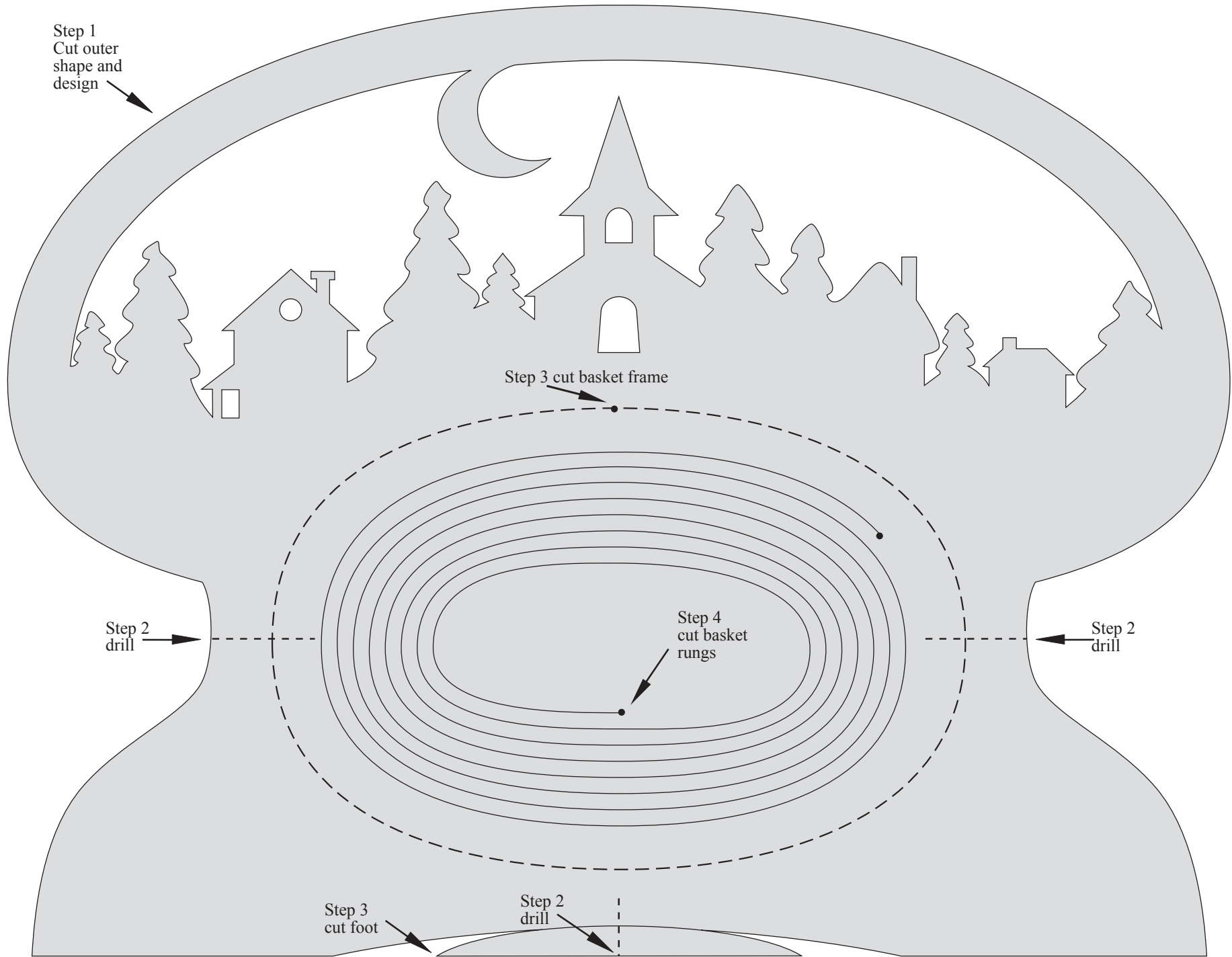

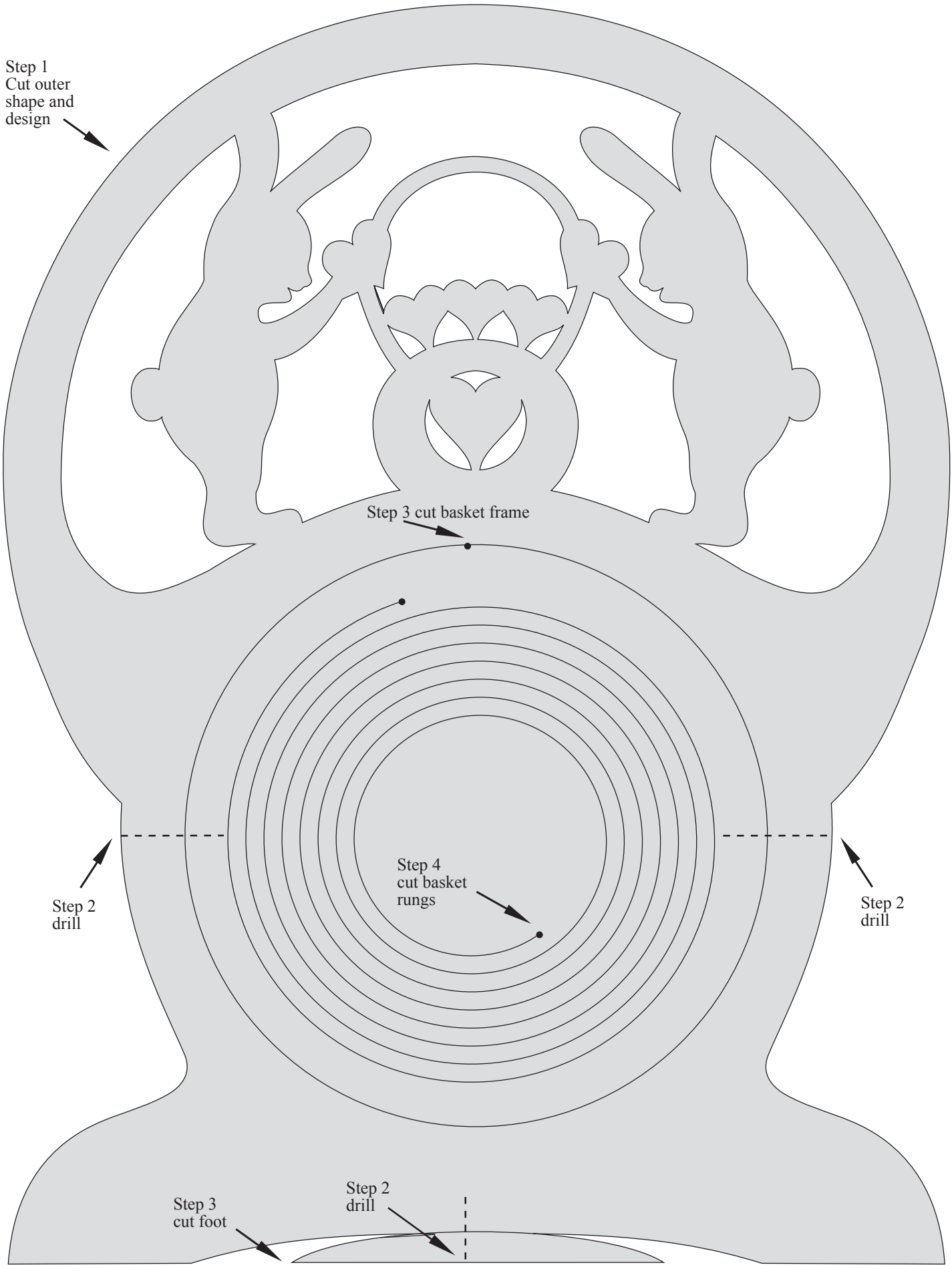

Step 1
Cut outer
shape and
design

Step 3 cut basket frame

Step 4
cut basket
rungs

Step 2
drill

Step 2
drill

Step 3
cut foot

Step 2
drill

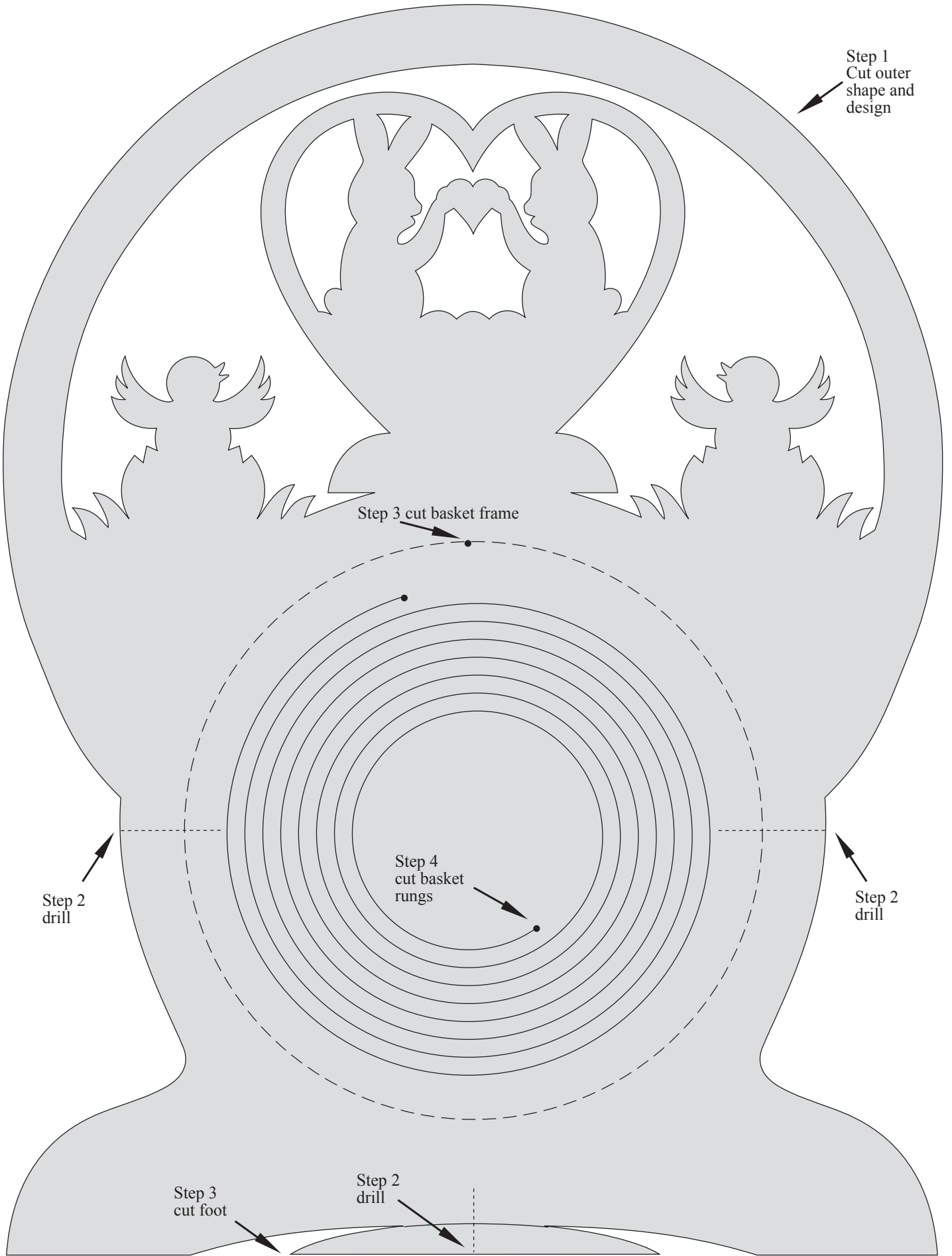

Step 1
Cut outer
shape and
design

Step 3 cut basket frame

Step 2
drill

Step 2
drill

Step 4
cut basket
rungs

Step 3
cut foot

Step 2
drill

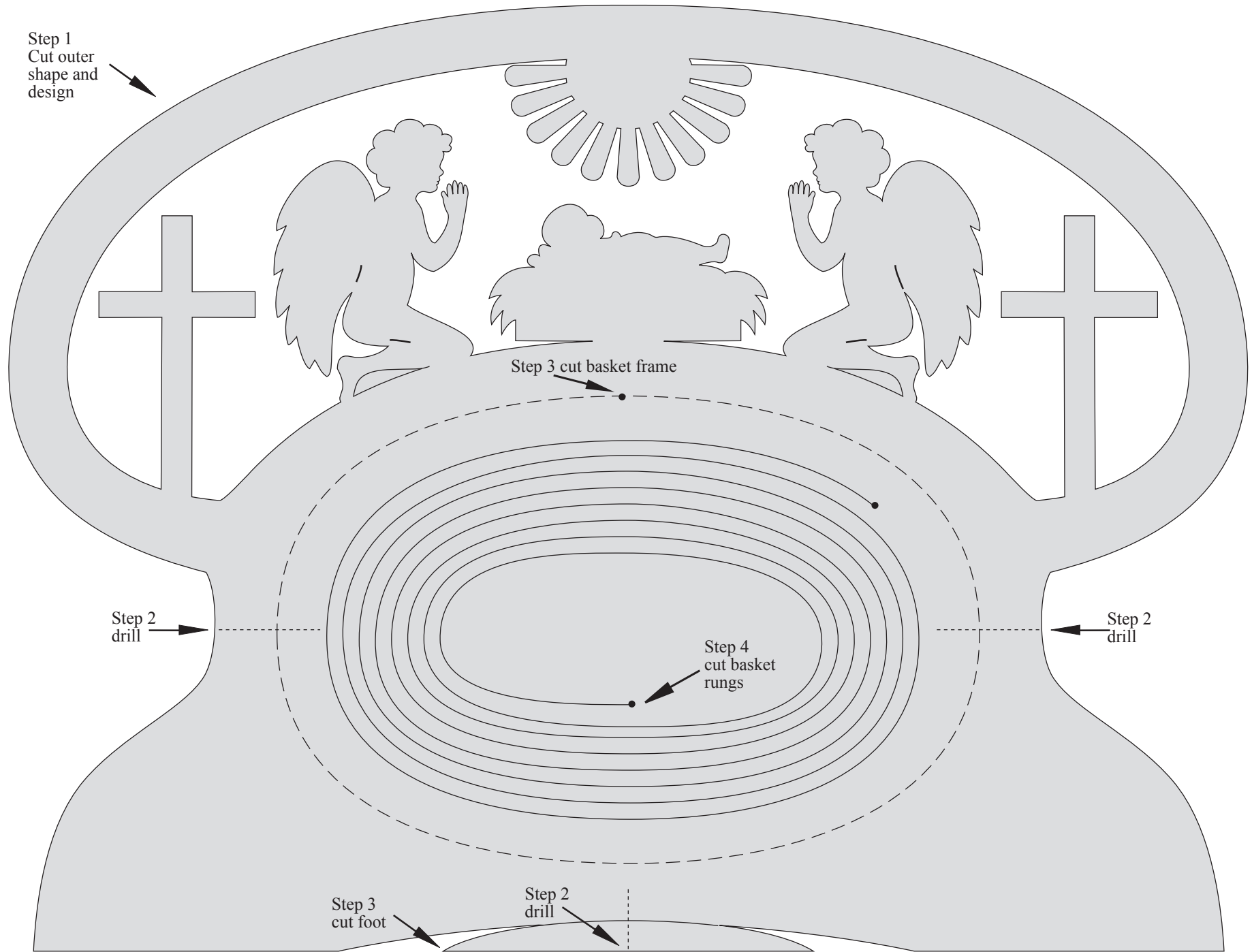

Step 1
Cut outer
shape and
design

Step 3 cut basket frame

Step 2
drill

Step 2
drill

Step 4
cut basket
rungs

Step 3
cut foot

Step 2
drill

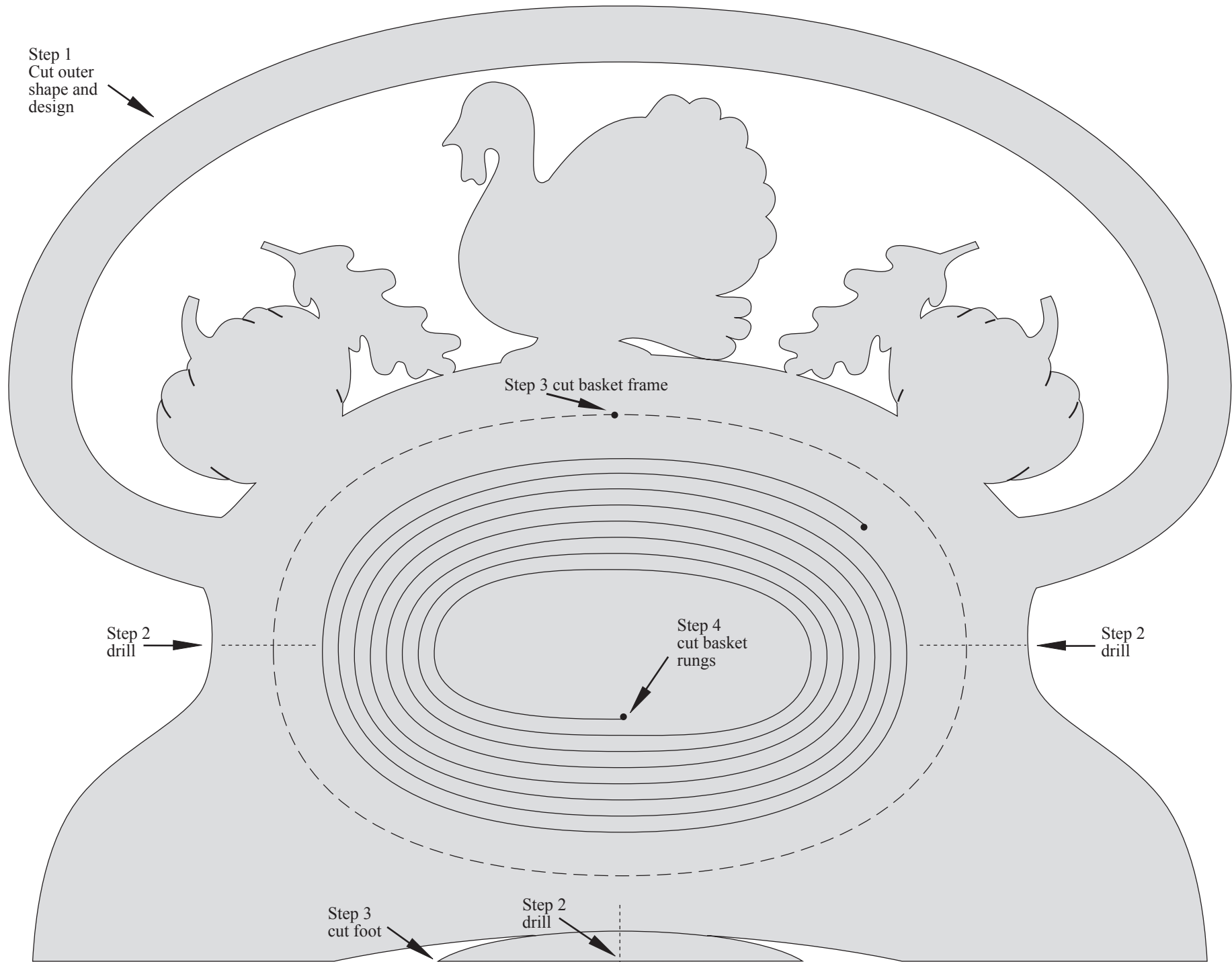

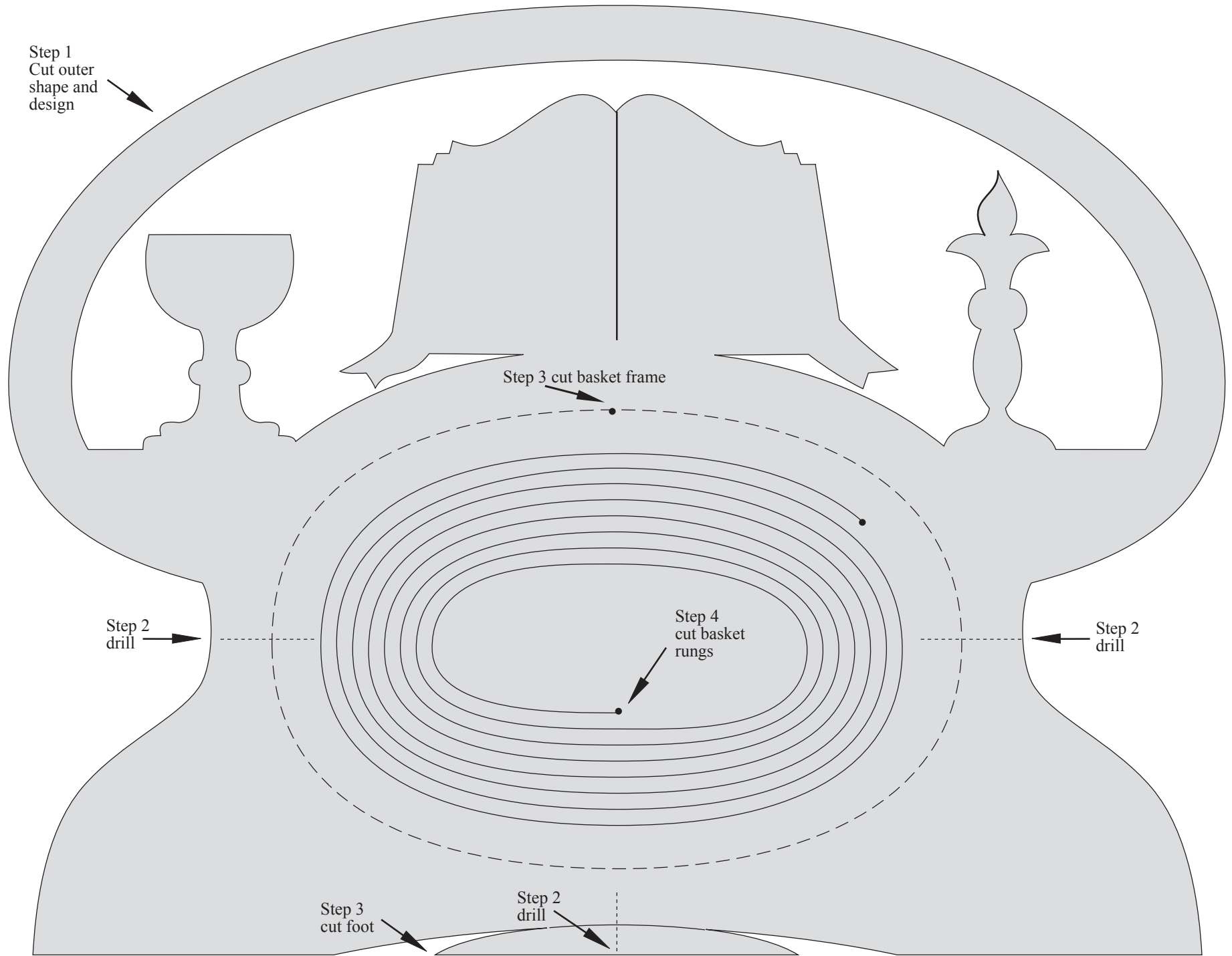

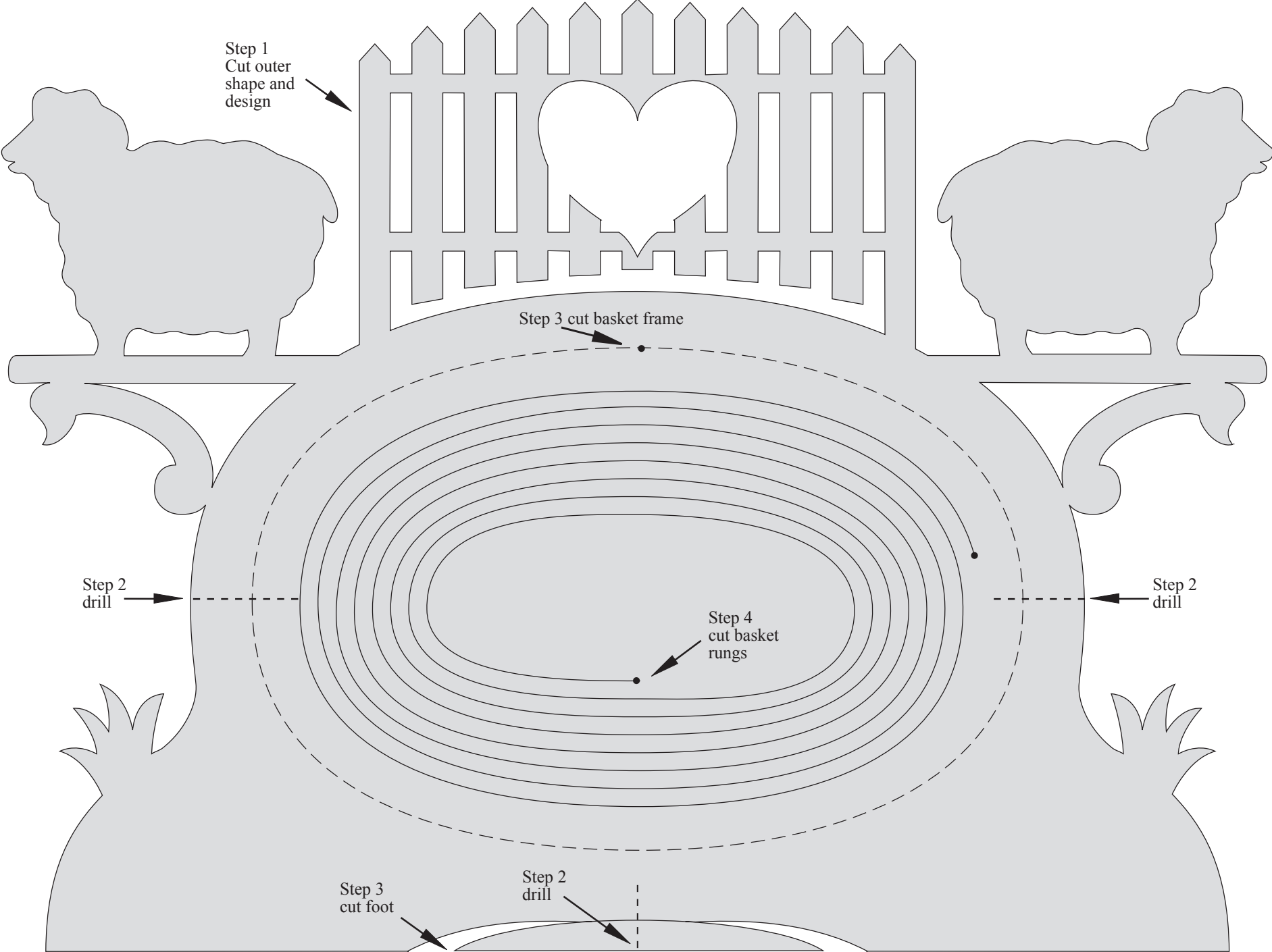

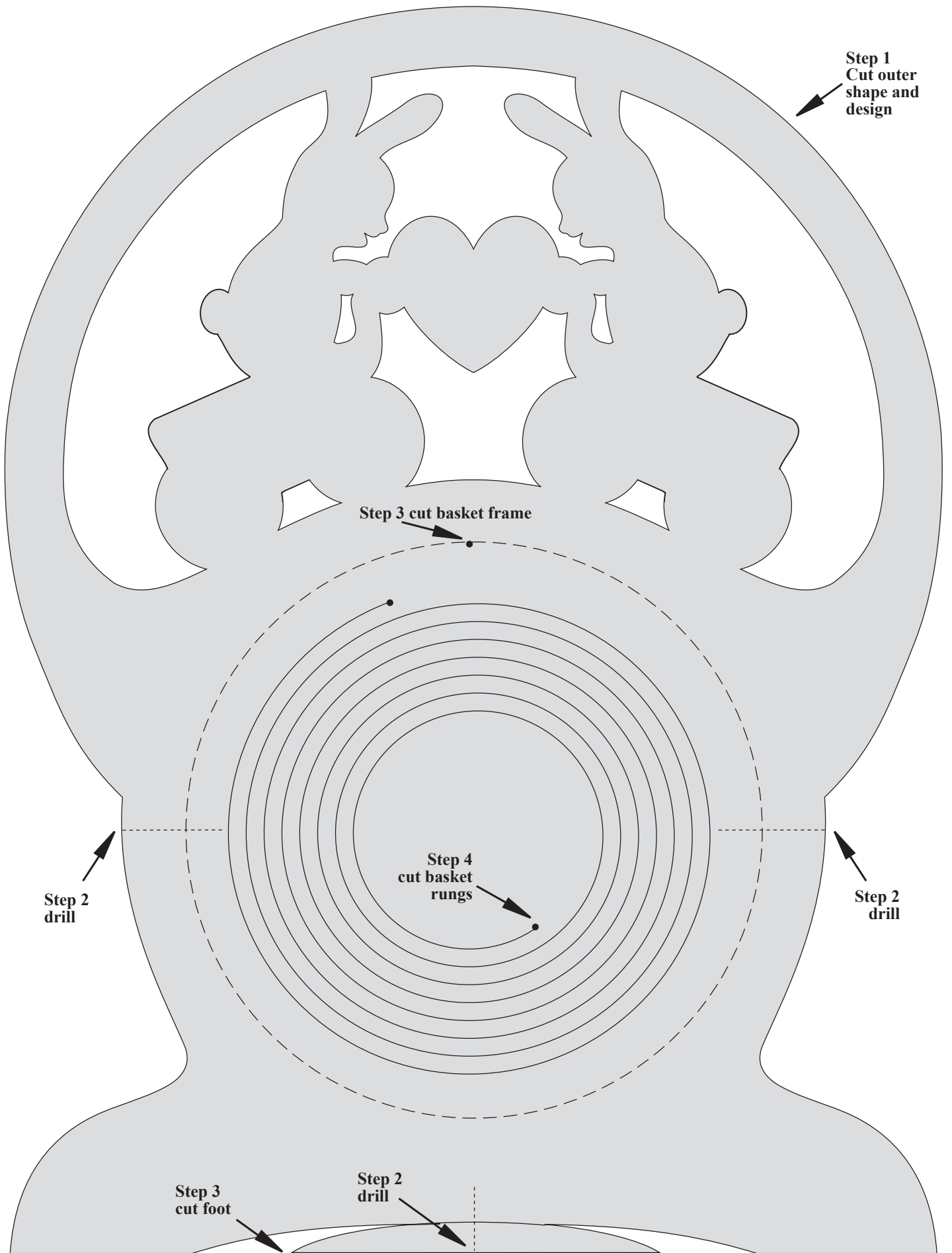

Step 1
Cut outer
shape and
design

Step 3 cut basket frame

Step 2
drill

Step 4
cut basket
rungs

Step 2
drill

Step 3
cut foot

Step 2
drill

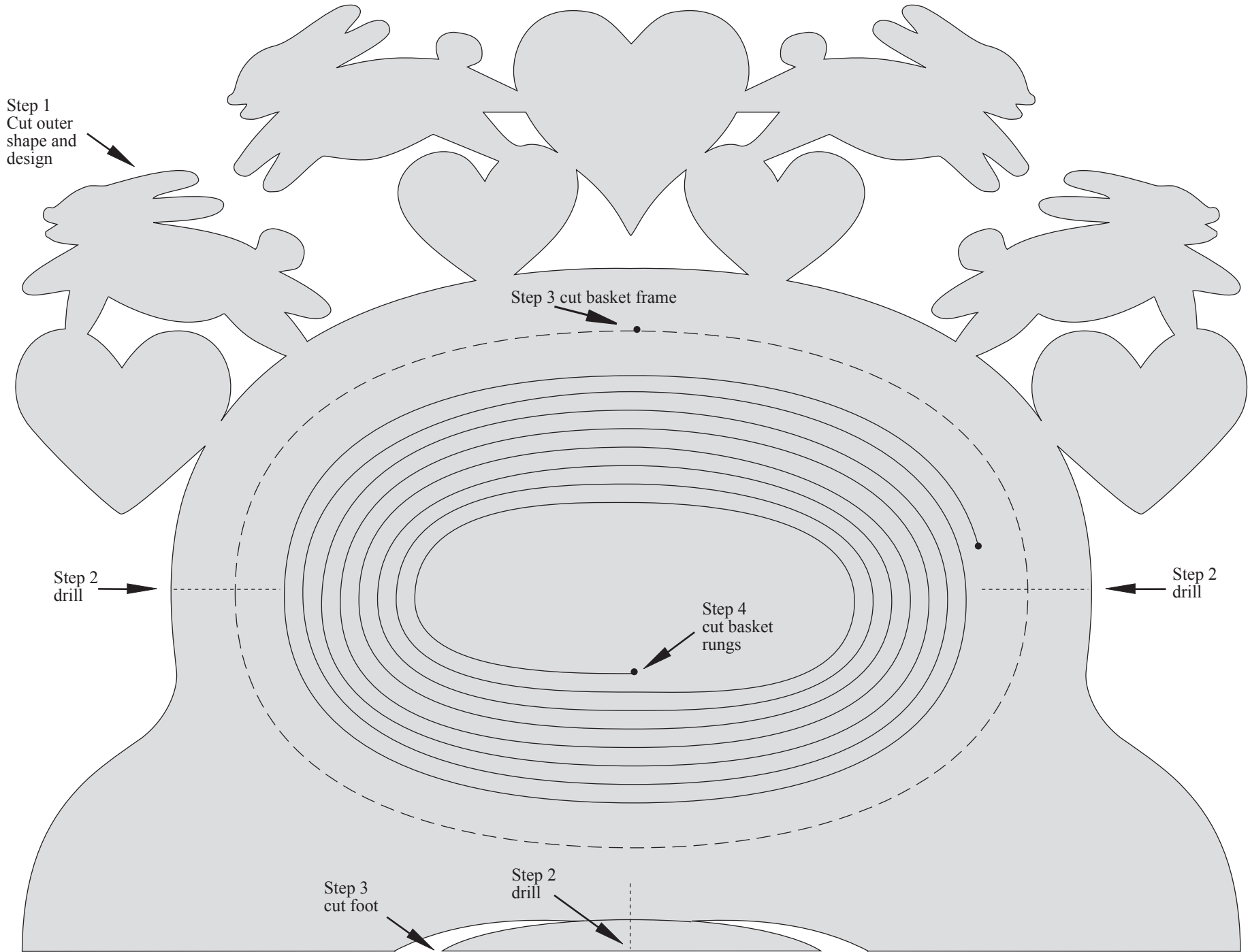

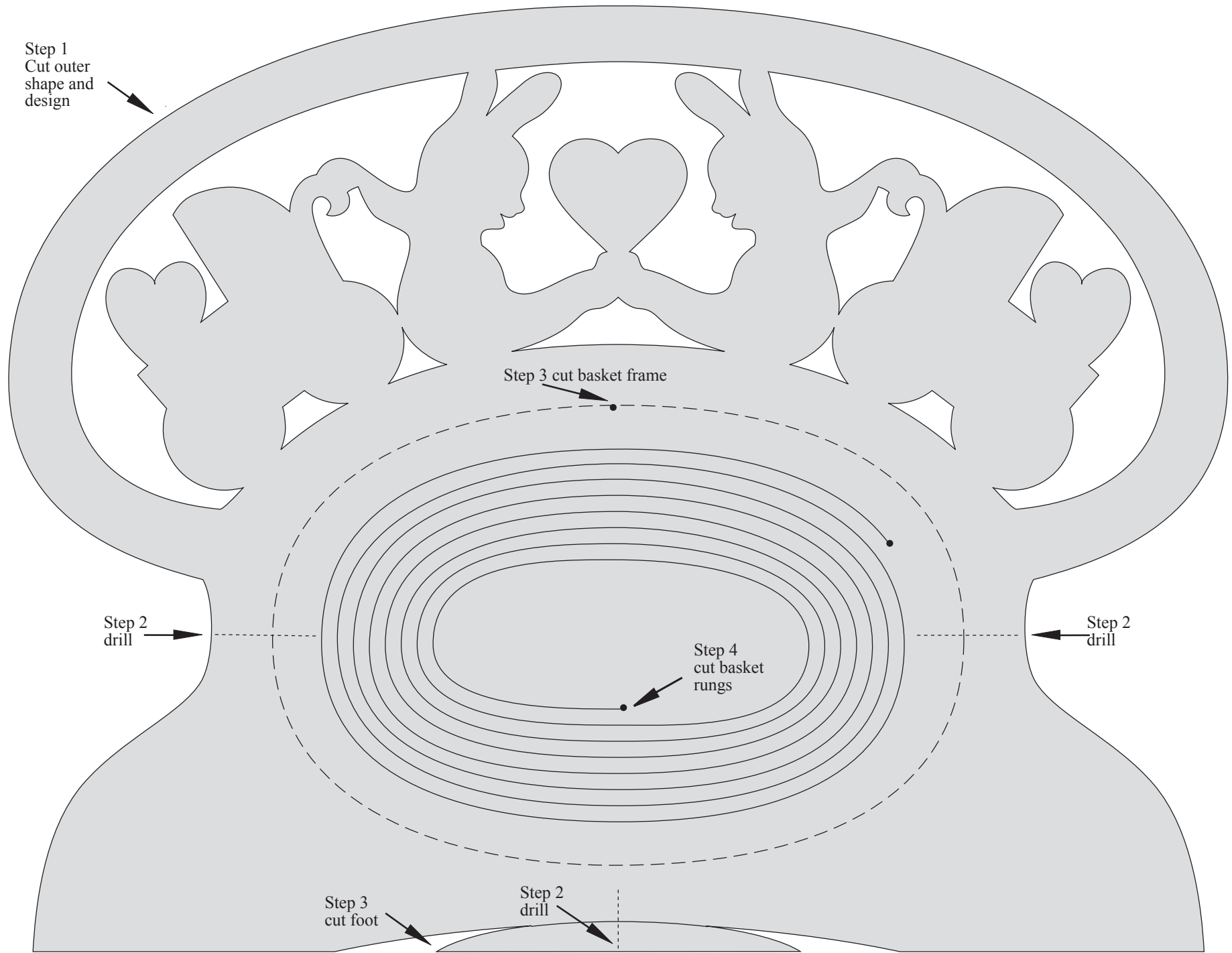

Step 1
Cut outer
shape and
design

Step 3 cut basket frame

Step 2
drill

Step 2
drill

Step 4
cut basket
rungs

Step 3
cut foot

Step 2
drill

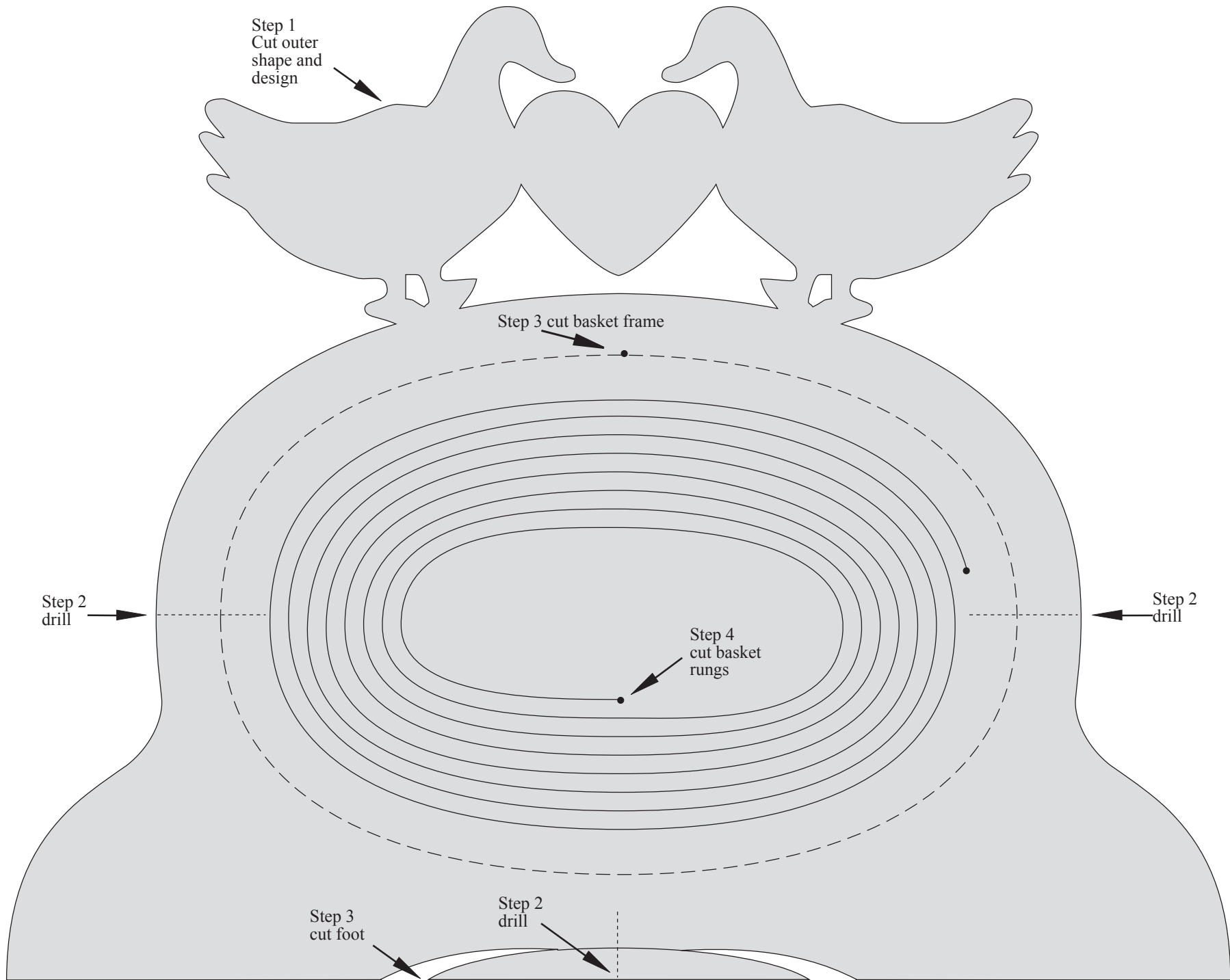

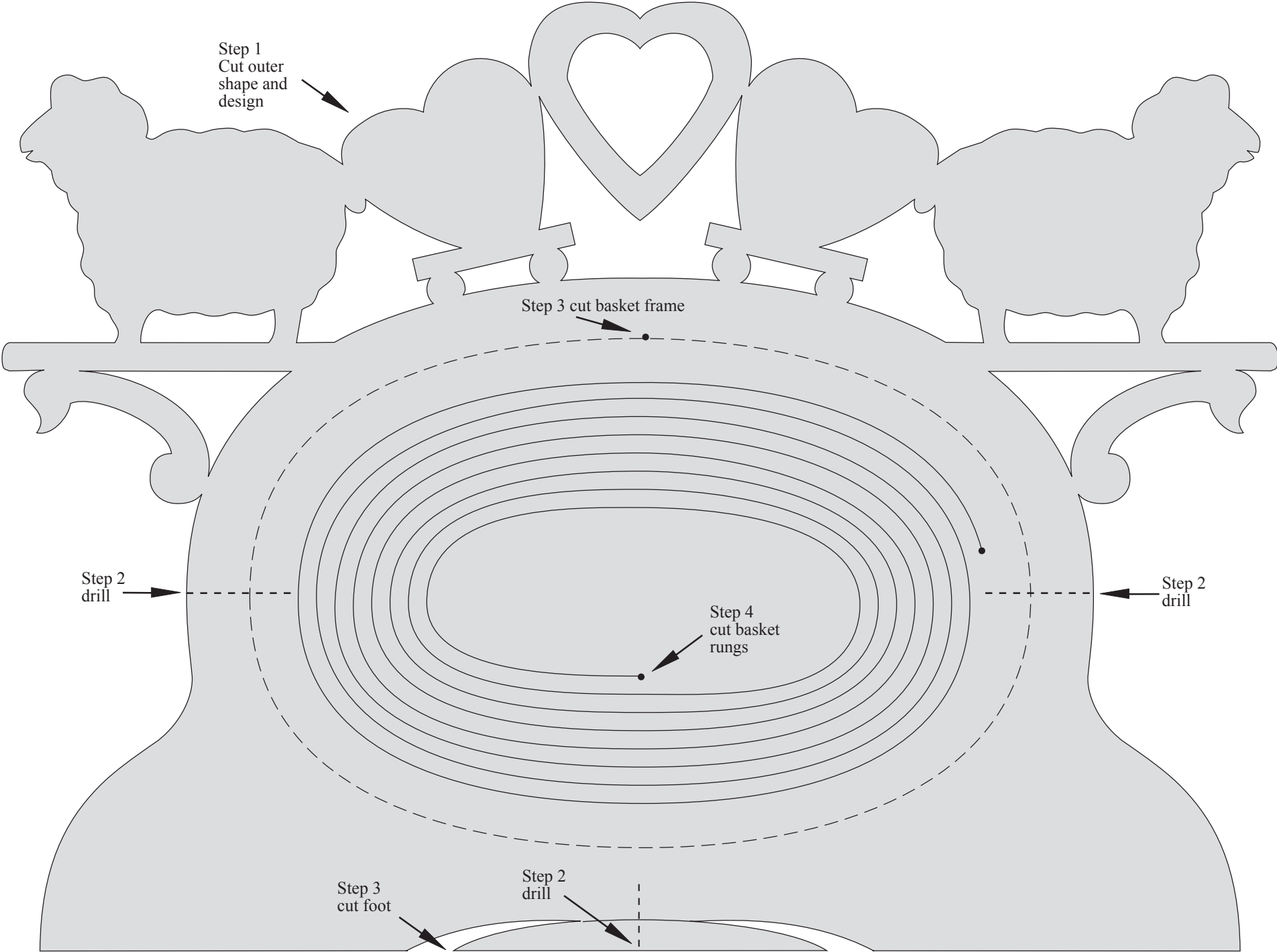

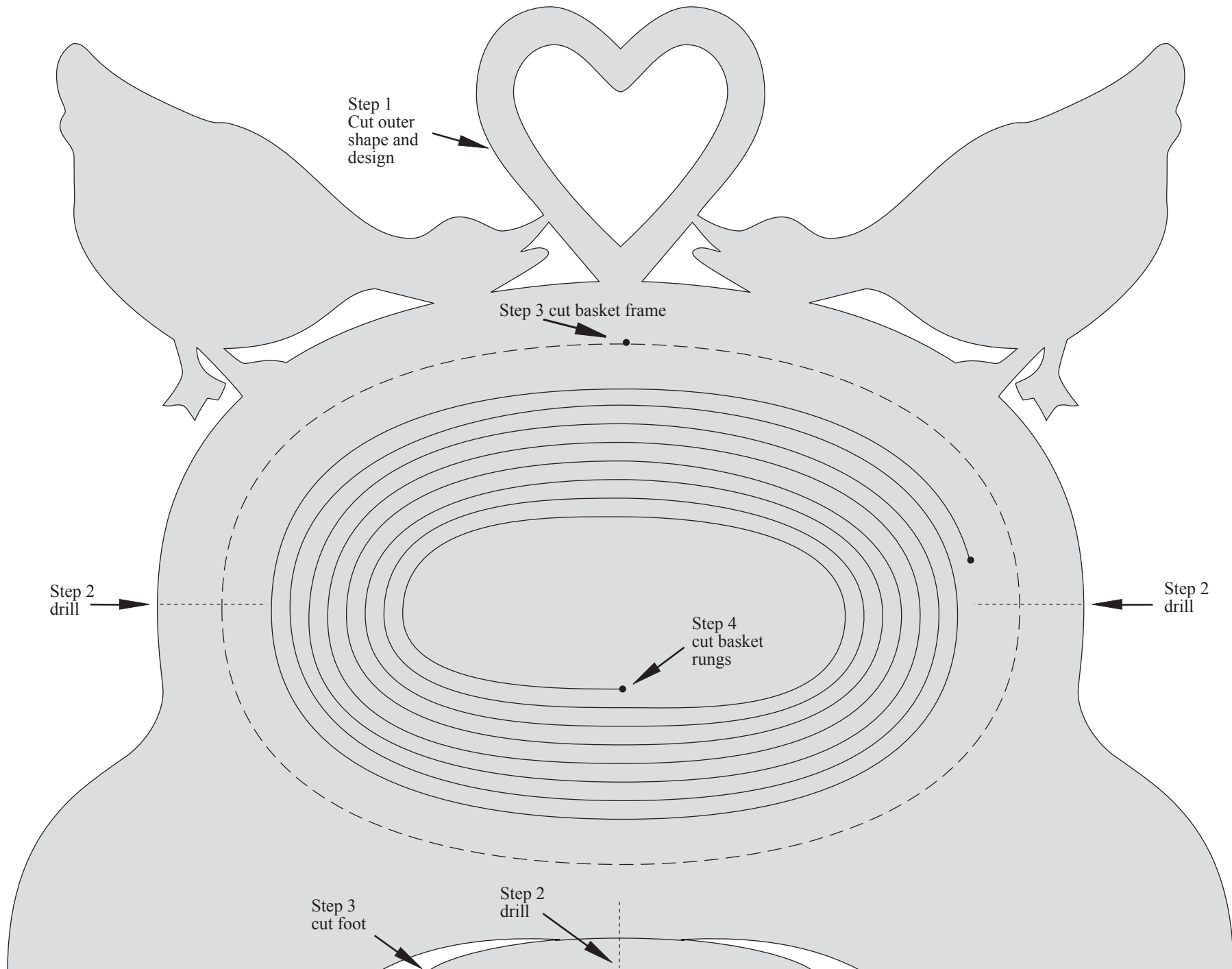

Step 1
Cut outer
shape and
design

Step 3 cut basket frame

Step 2
drill

Step 2
drill

Step 4
cut basket
rungs

Step 3
cut foot

Step 2
drill

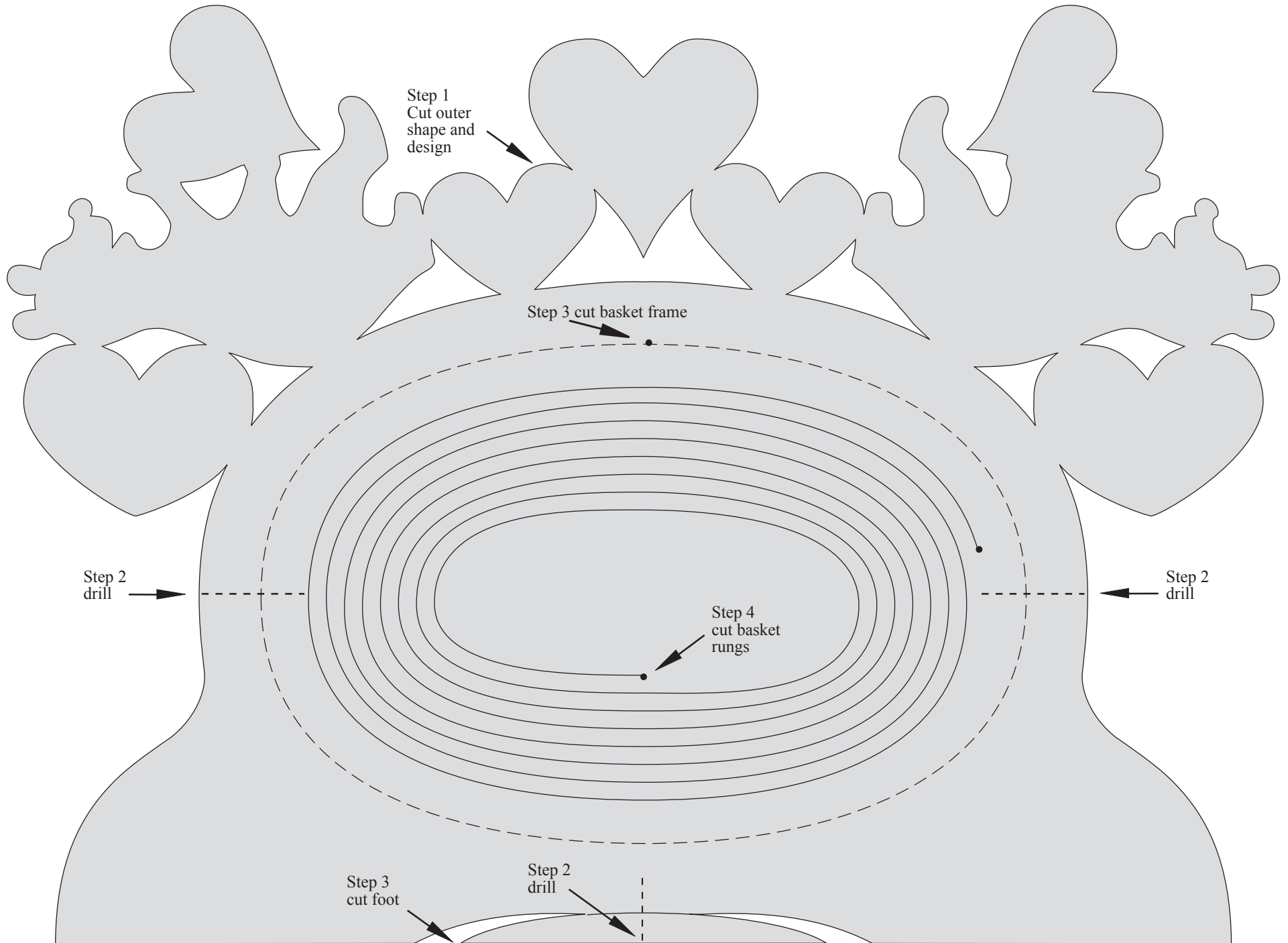

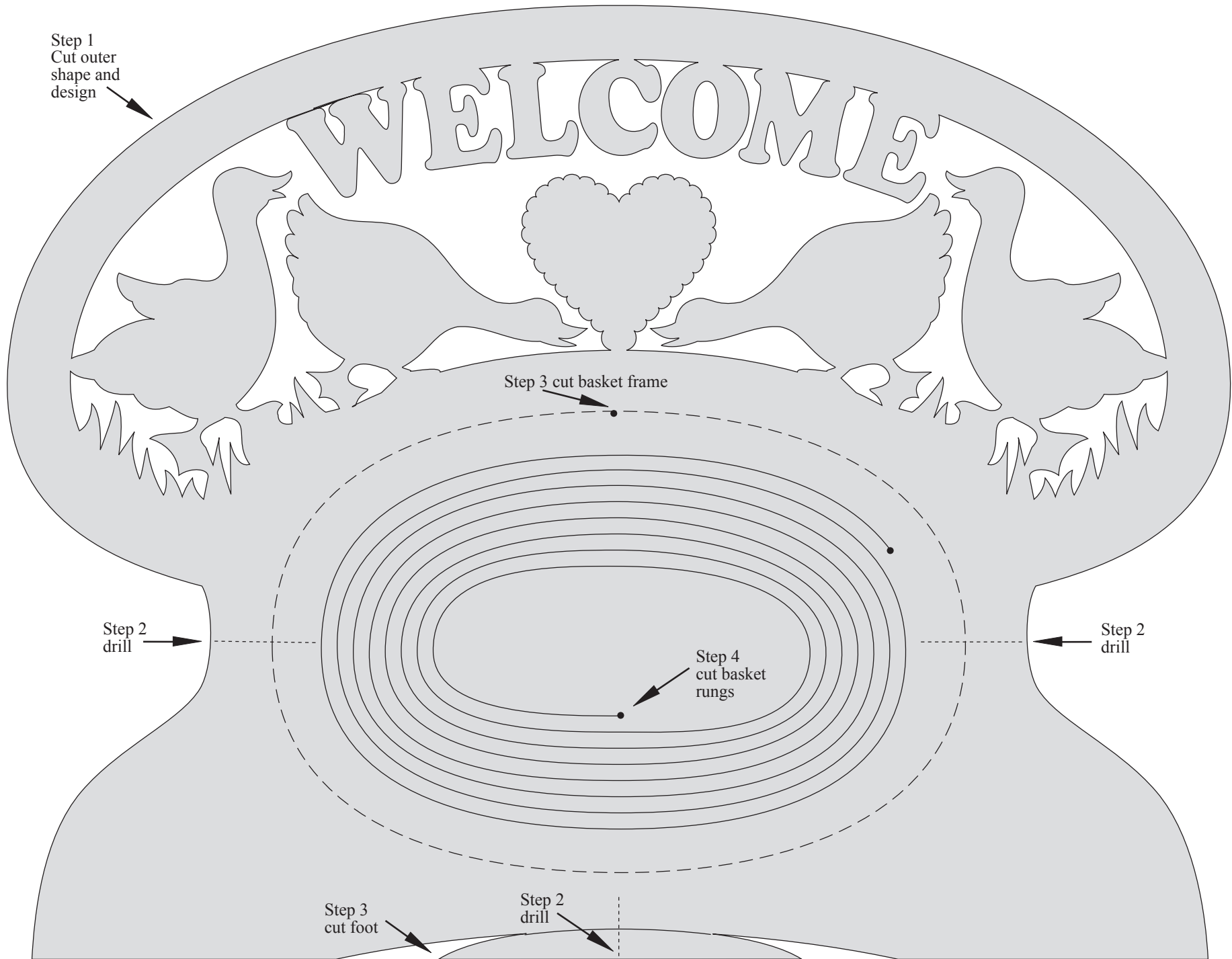

Step 1
Cut outer
shape and
design

WELCOME

Step 3 cut basket frame

Step 2
drill

Step 2
drill

Step 4
cut basket
rungs

Step 3
cut foot

Step 2
drill

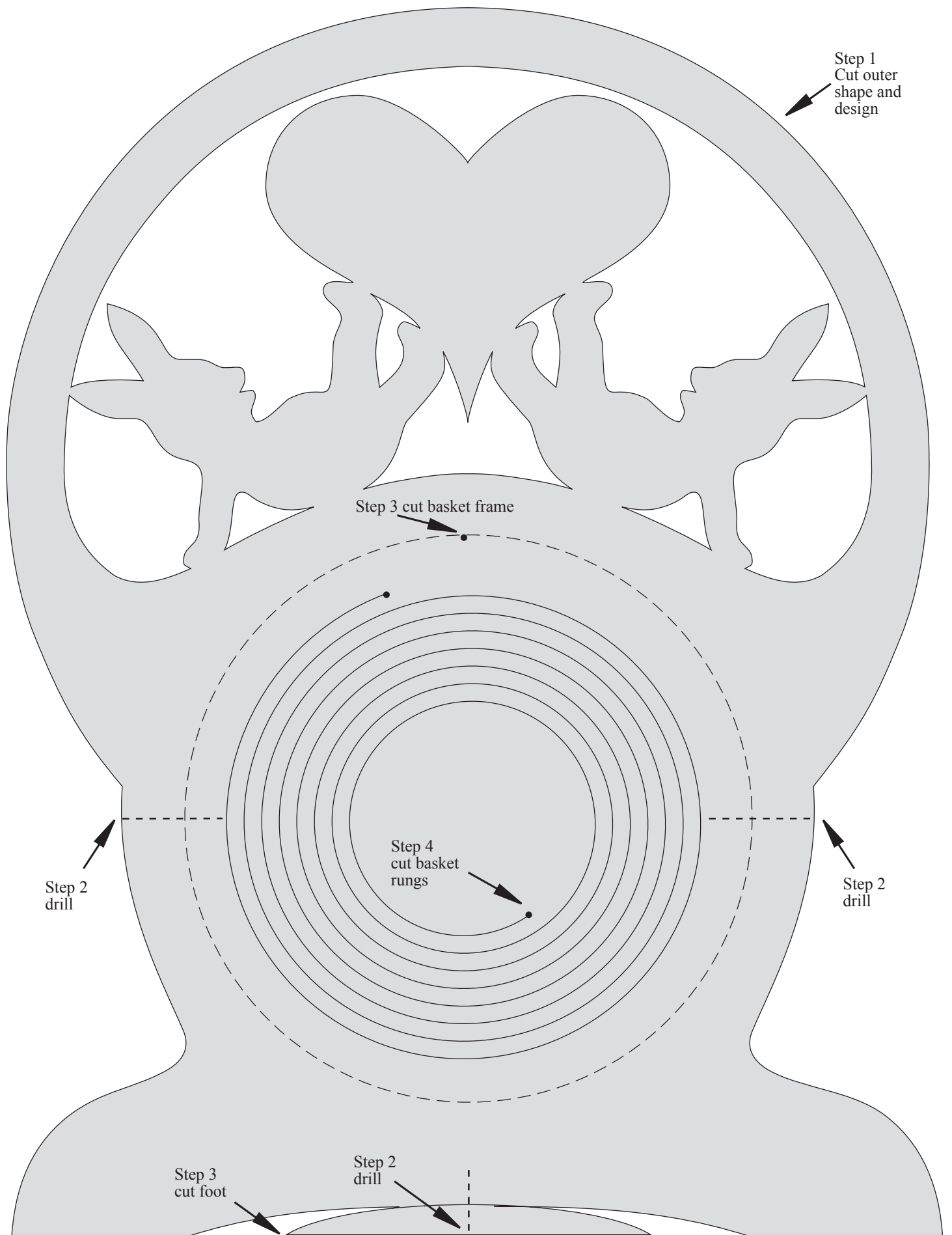

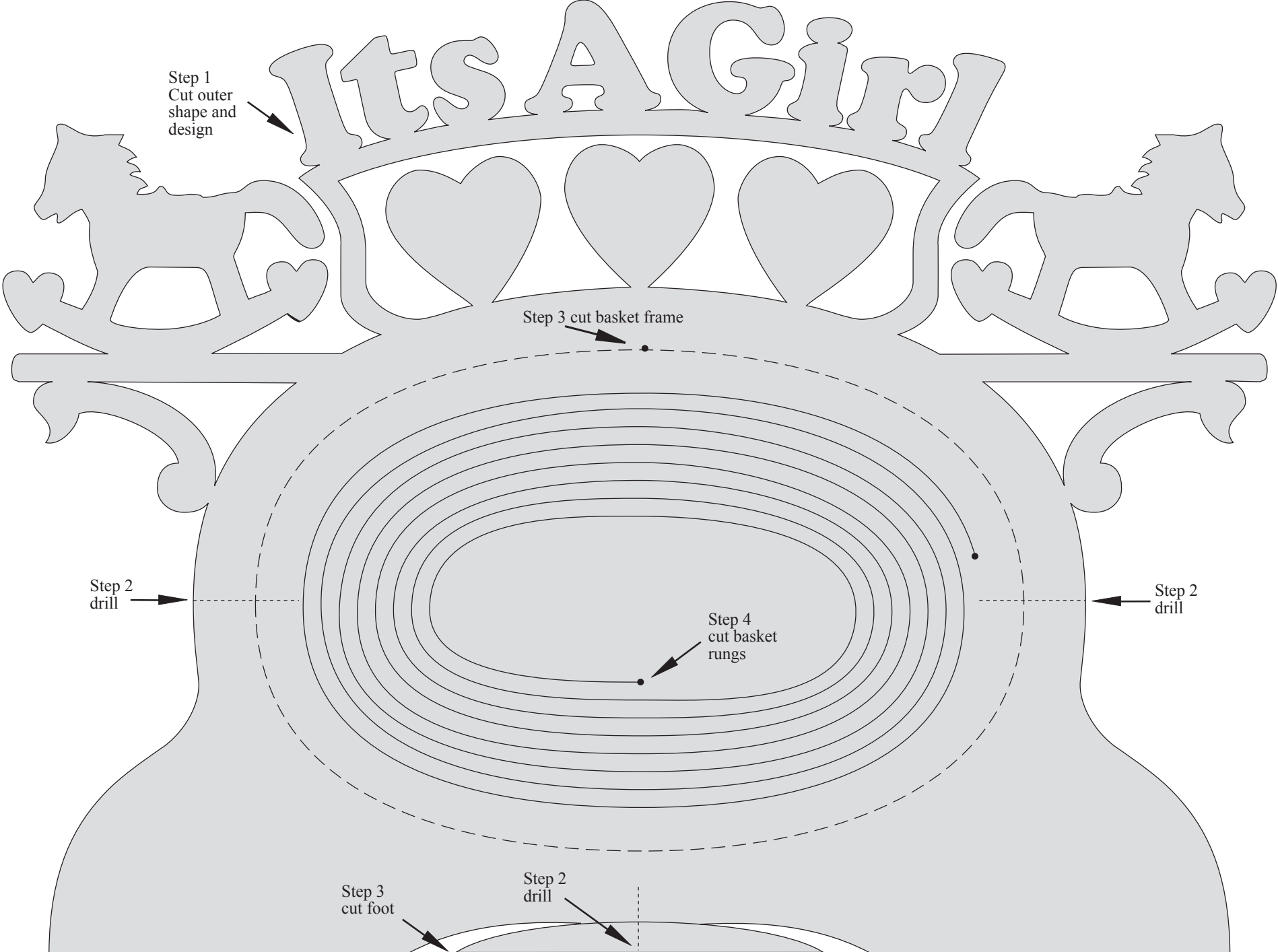

Step 1
Cut outer
shape and
design

Step 3 cut basket frame

Step 2
drill

Step 2
drill

Step 4
cut basket
rungs

Step 3
cut foot

Step 2
drill

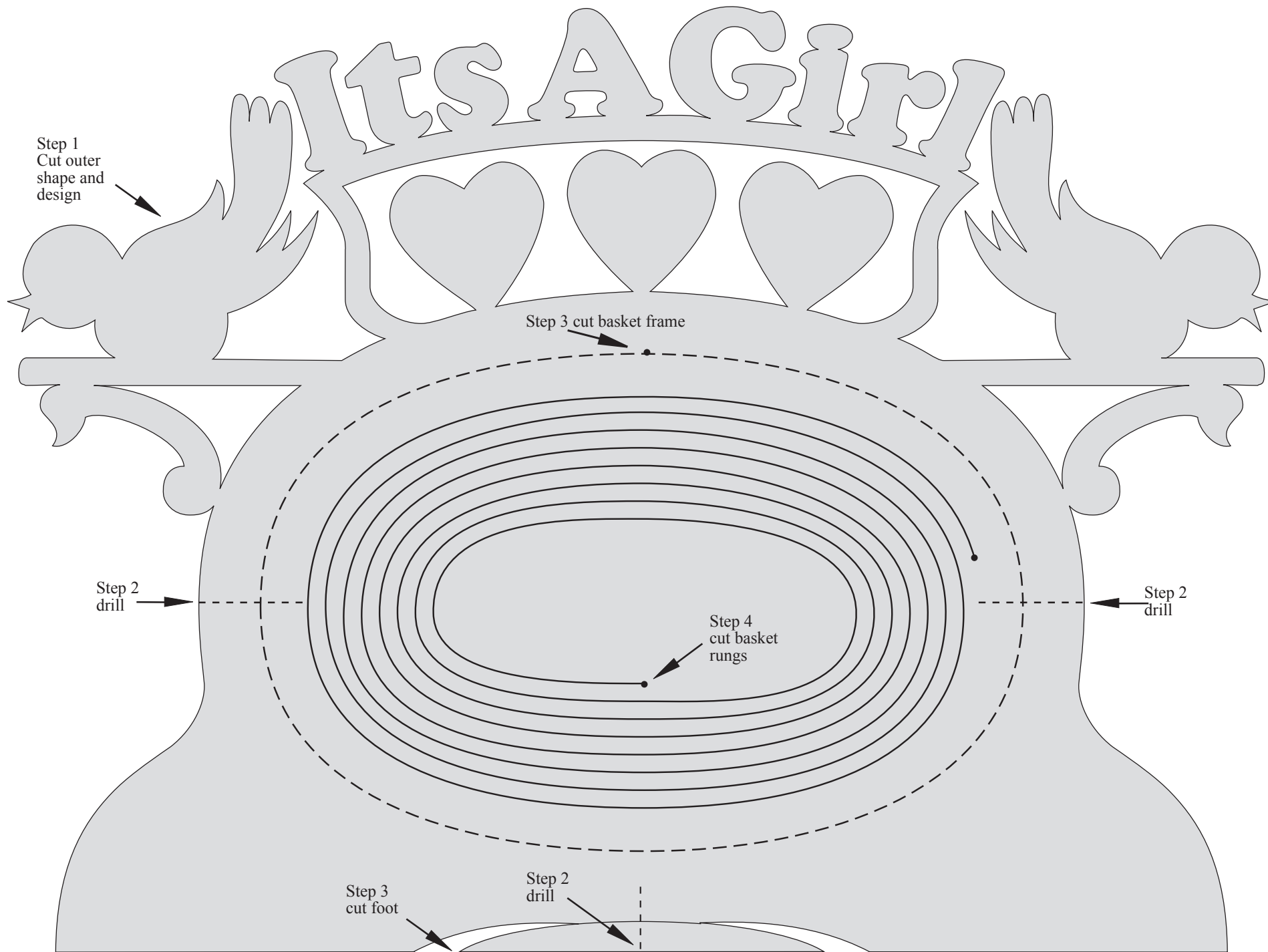

Step 1
Cut outer
shape and
design

Step 3 cut basket frame

Step 2
drill

Step 2
drill

Step 4
cut basket
rungs

Step 3
cut foot

Step 2
drill

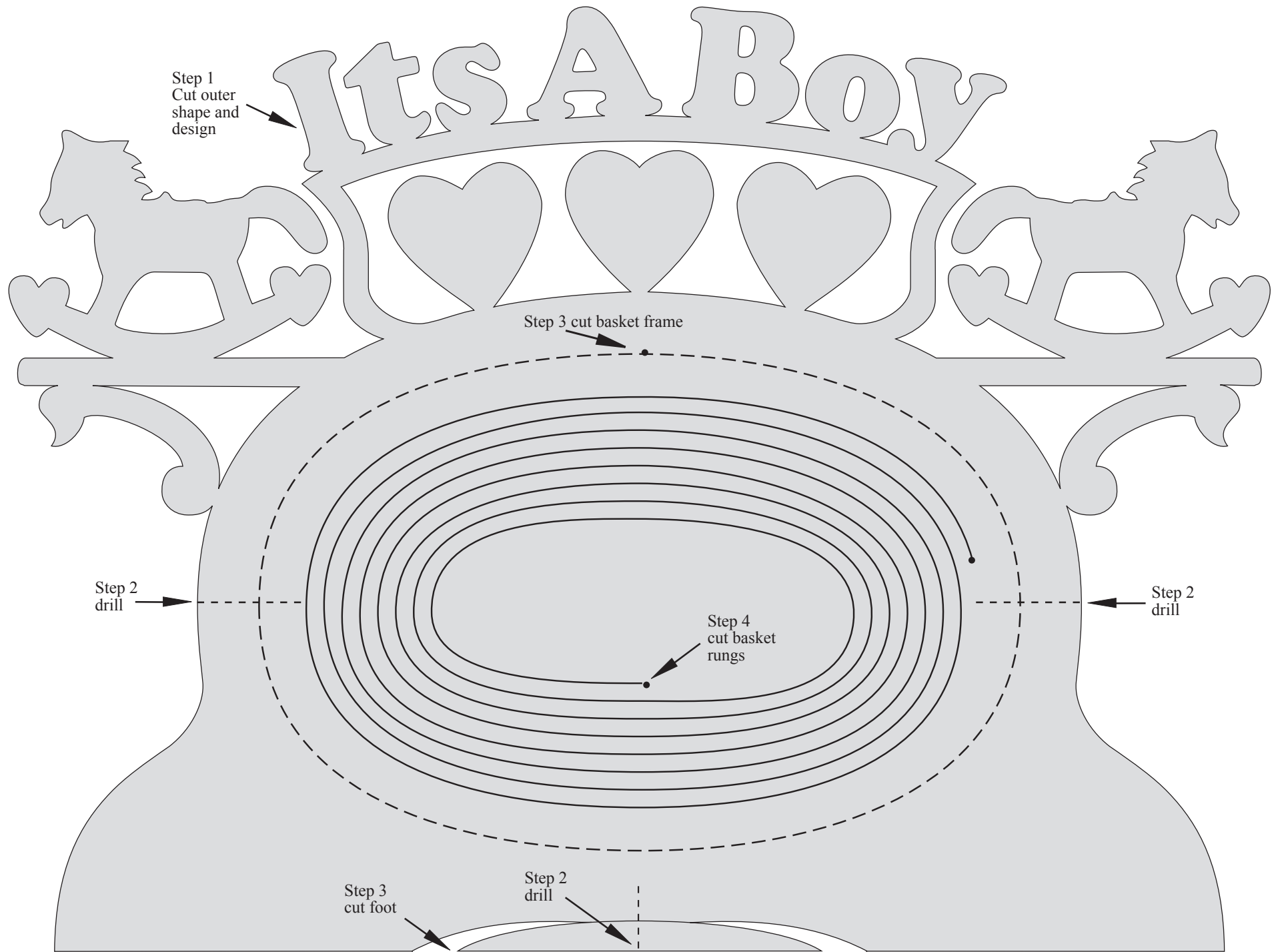

Step 1
Cut outer
shape and
design

Step 3 cut basket frame

Step 2
drill

Step 2
drill

Step 4
cut basket
rungs

Step 3
cut foot

Step 2
drill

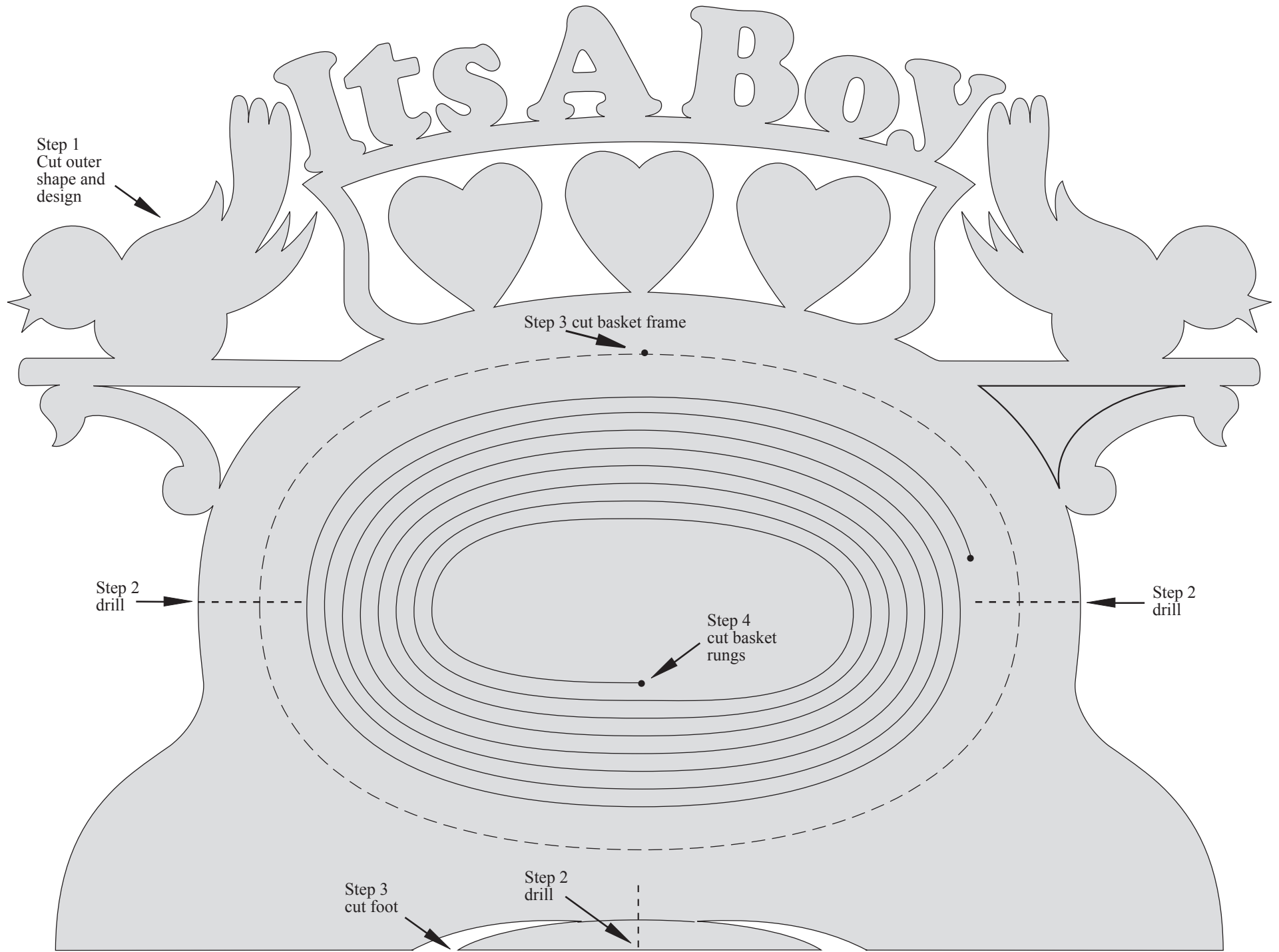

Step 1
Cut outer
shape and
design

Step 3 cut basket frame

Step 2
drill

Step 2
drill

Step 4
cut basket
rungs

Step 3
cut foot

Step 2
drill

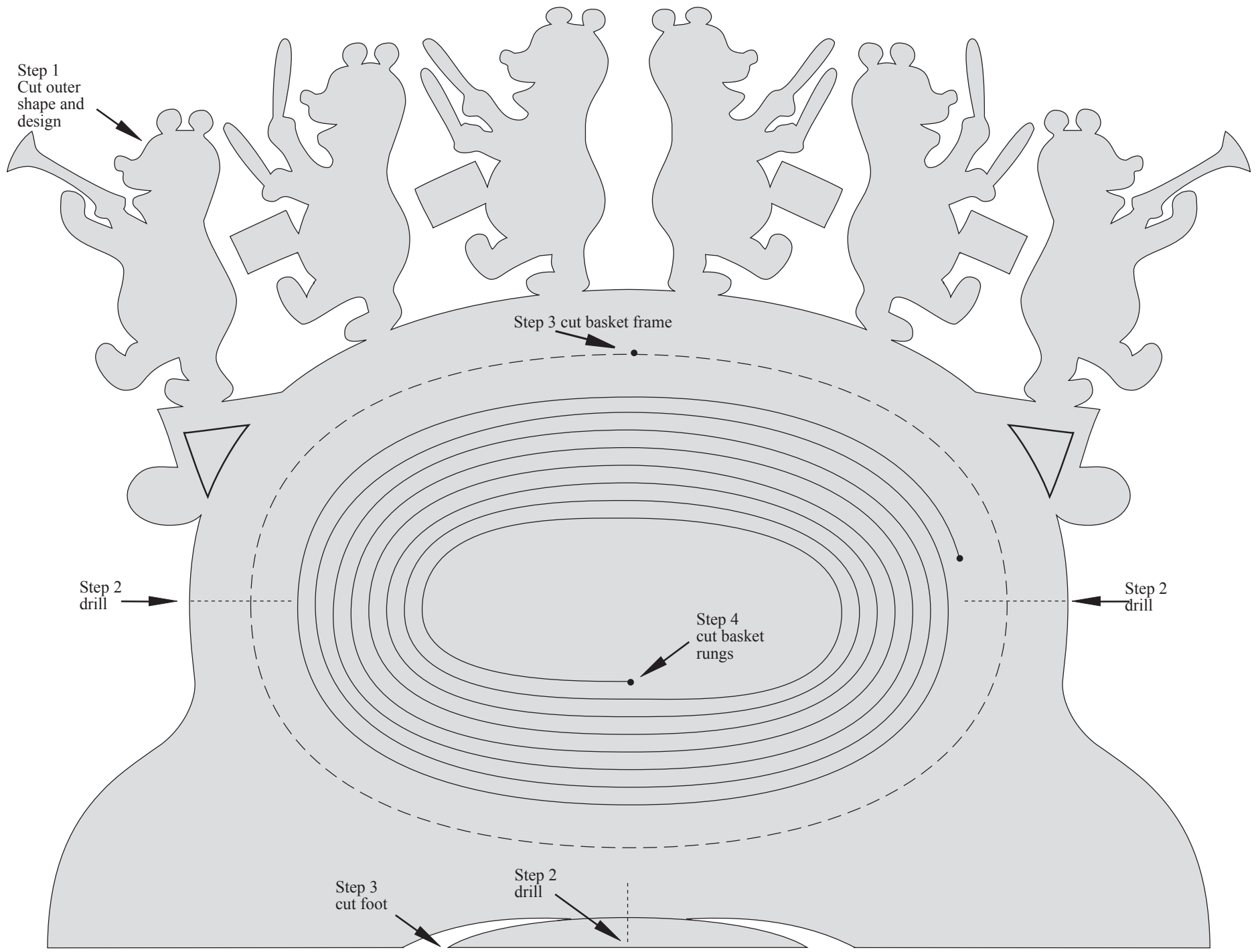

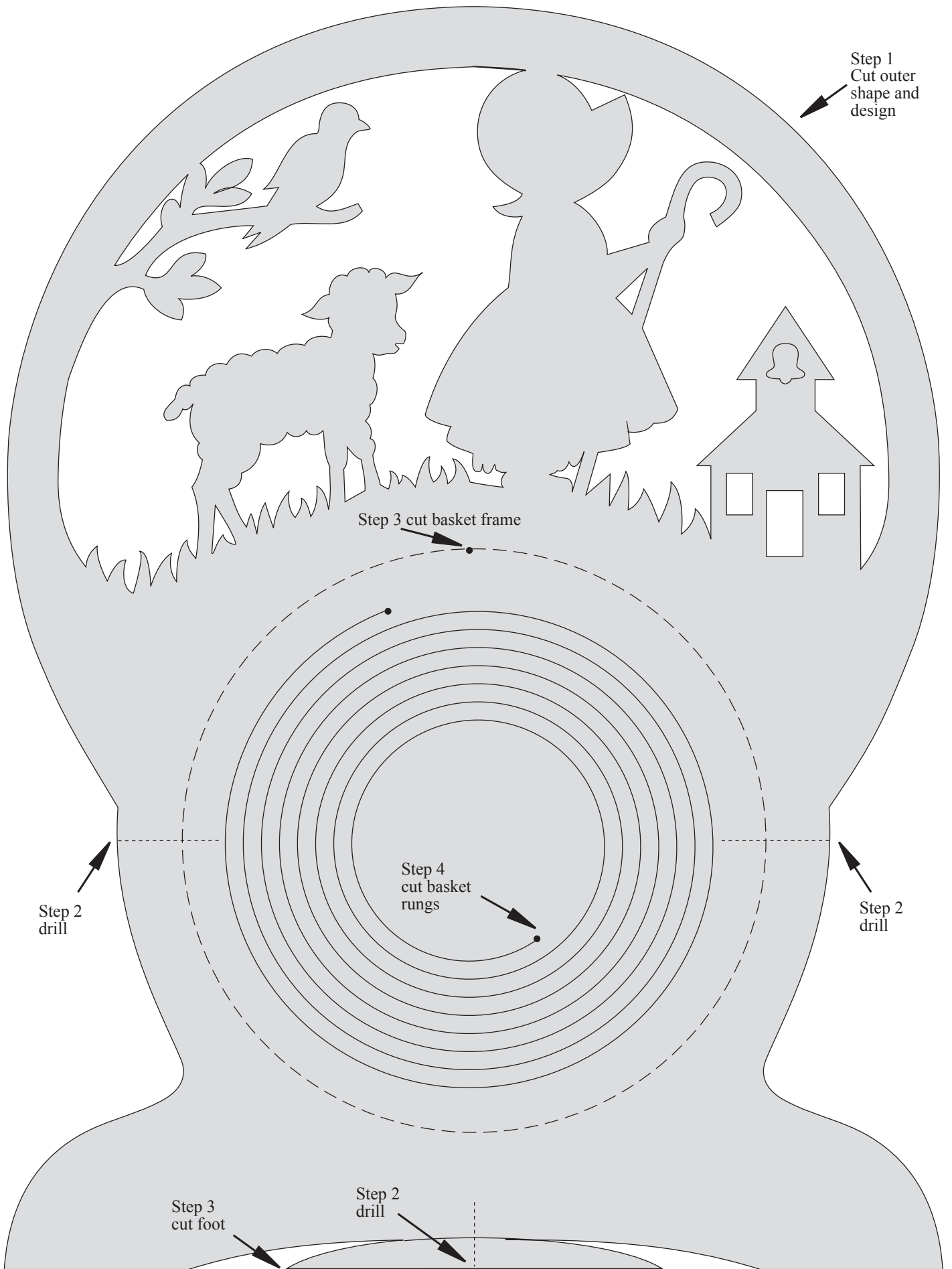

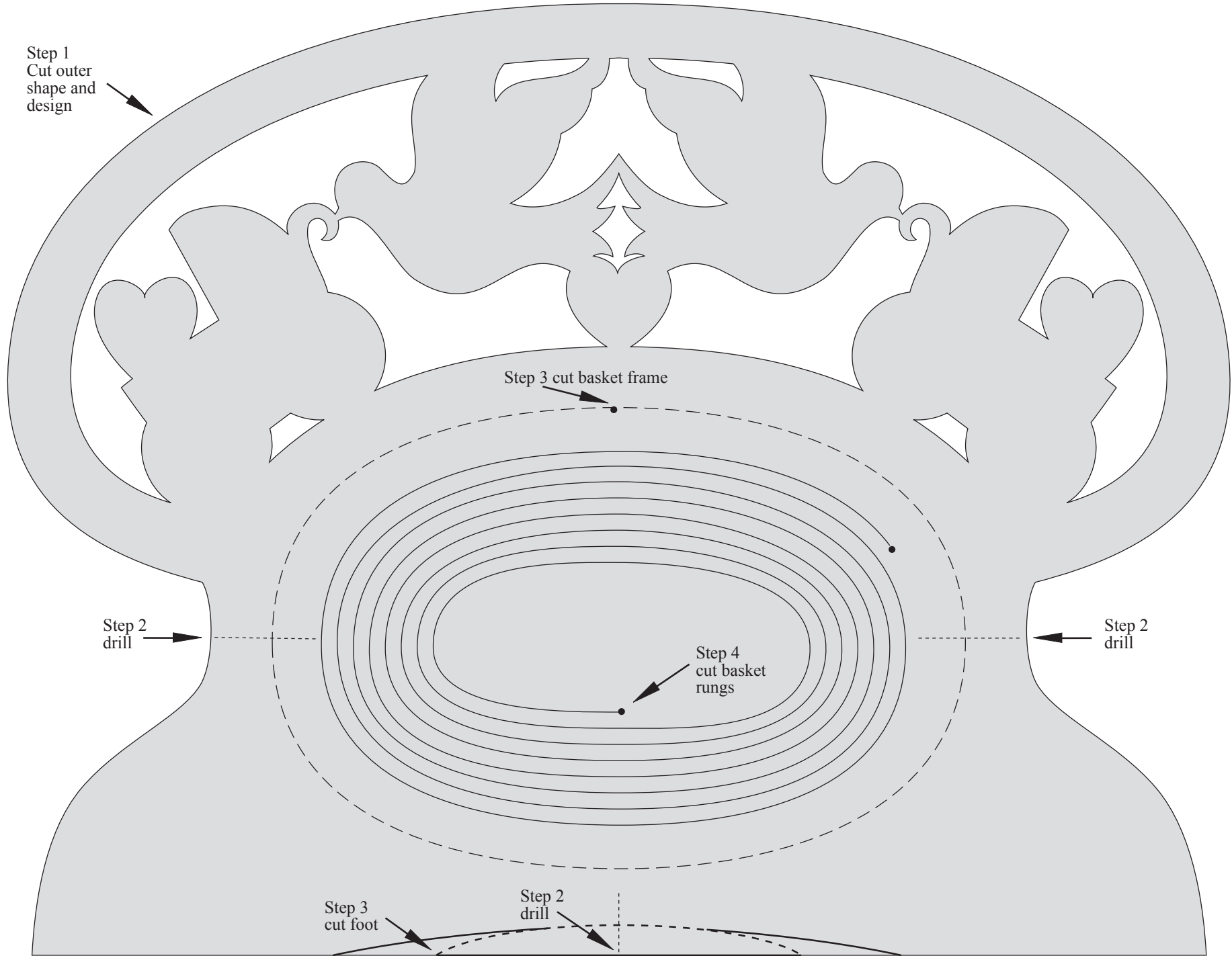

Step 1
Cut outer
shape and
design

Step 3 cut basket frame

Step 2
drill

Step 2
drill

Step 4
cut basket
rungs

Step 3
cut foot

Step 2
drill

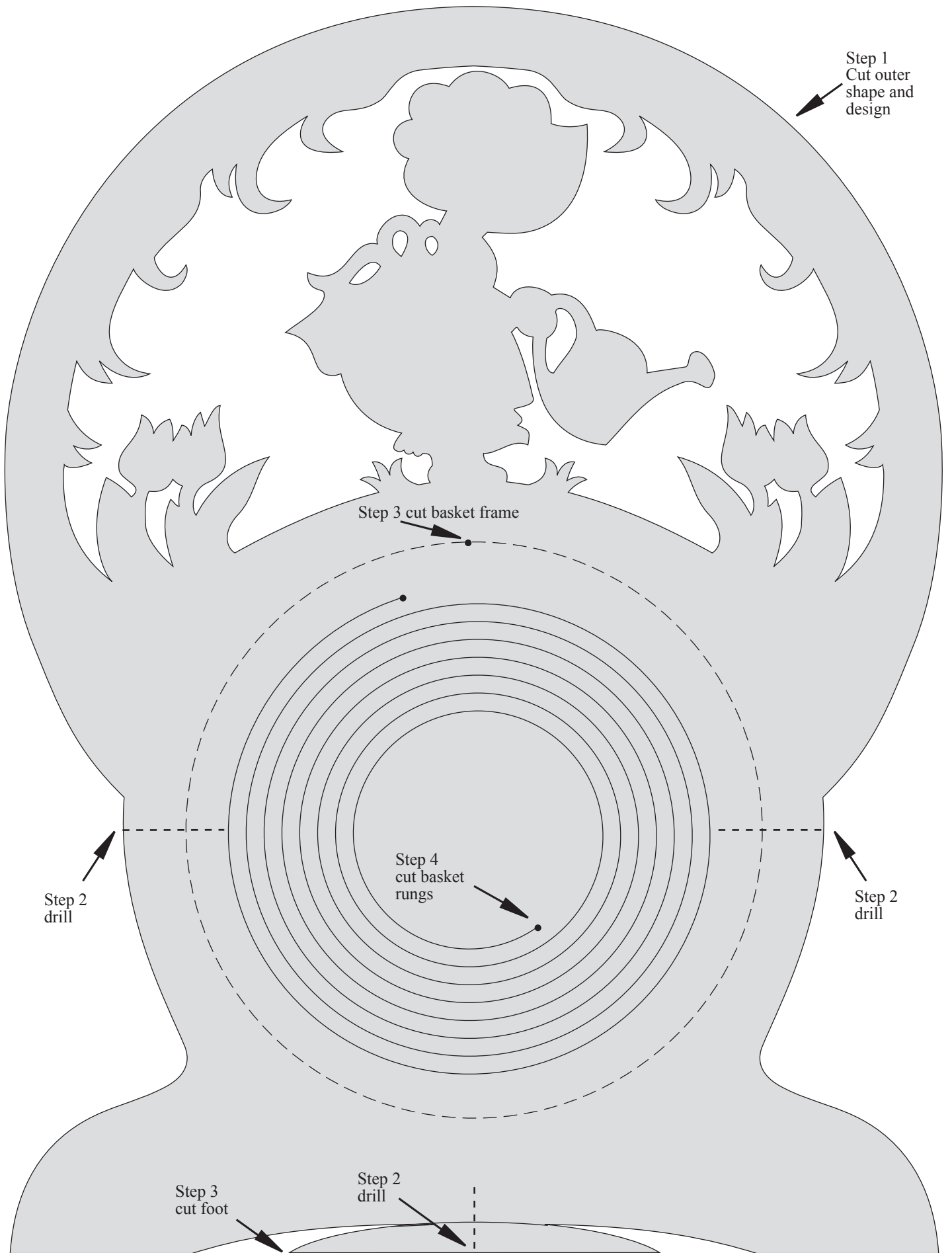

Step 1
Cut outer
shape and
design

Step 3 cut basket frame

Step 2
drill

Step 4
cut basket
rungs

Step 2
drill

Step 3
cut foot

Step 2
drill

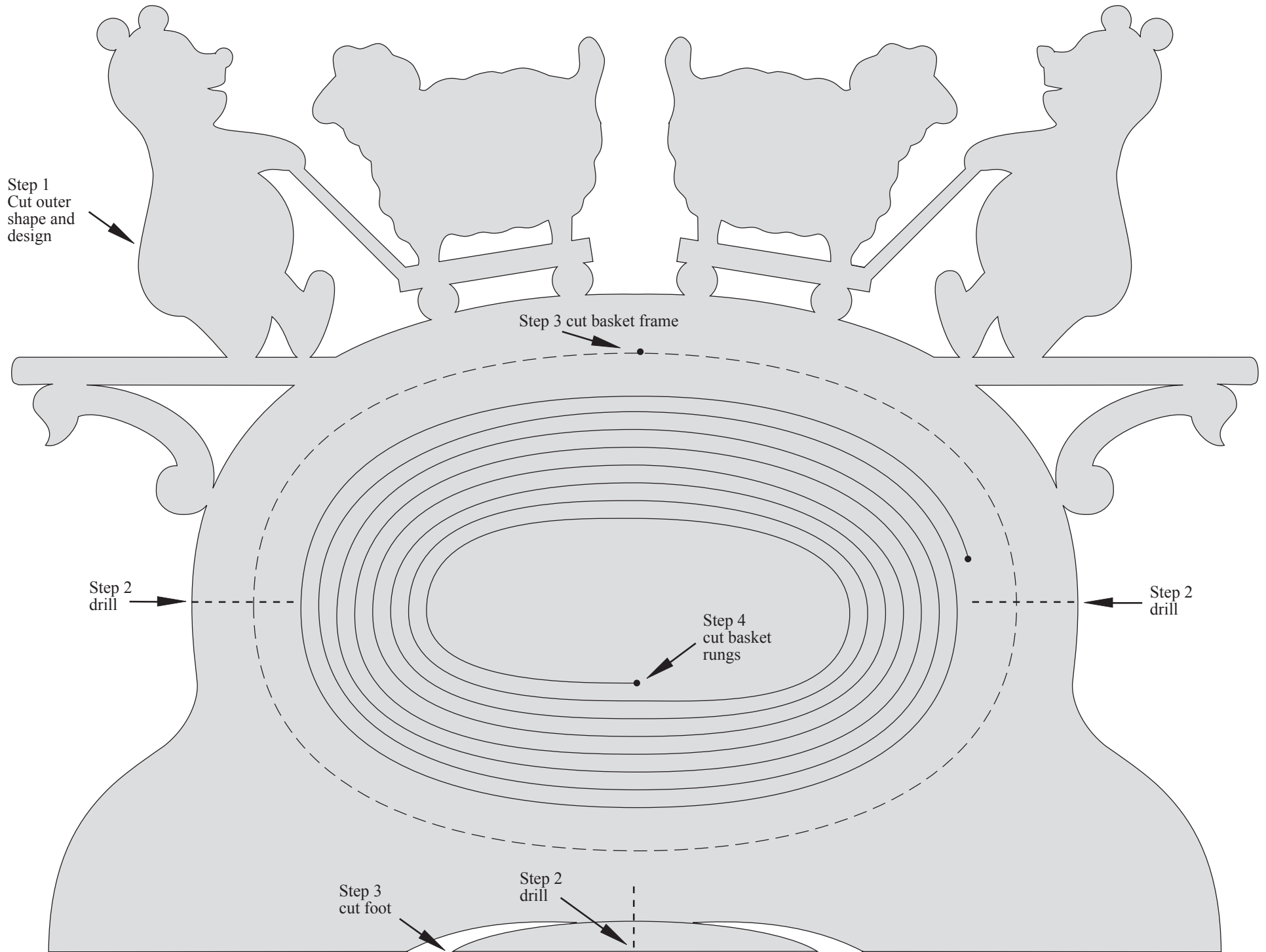

Step 1
Cut outer
shape and
design

Step 3 cut basket frame

Step 2
drill

Step 2
drill

Step 4
cut basket
rungs

Step 3
cut foot

Step 2
drill

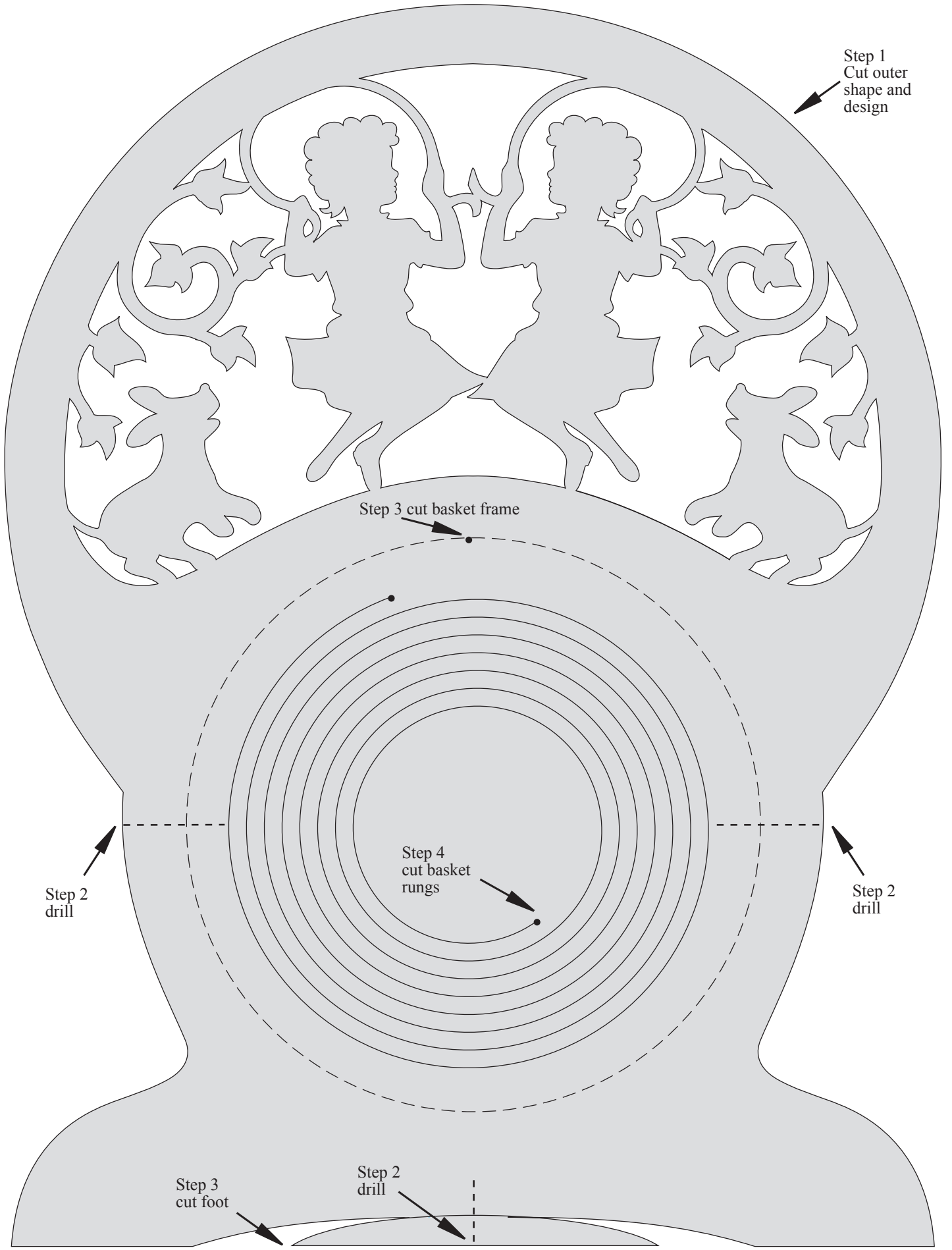

Step 1
Cut outer
shape and
design

Step 3 cut basket frame

Step 4
cut basket
rungs

Step 2
drill

Step 2
drill

Step 3
cut foot

Step 2
drill

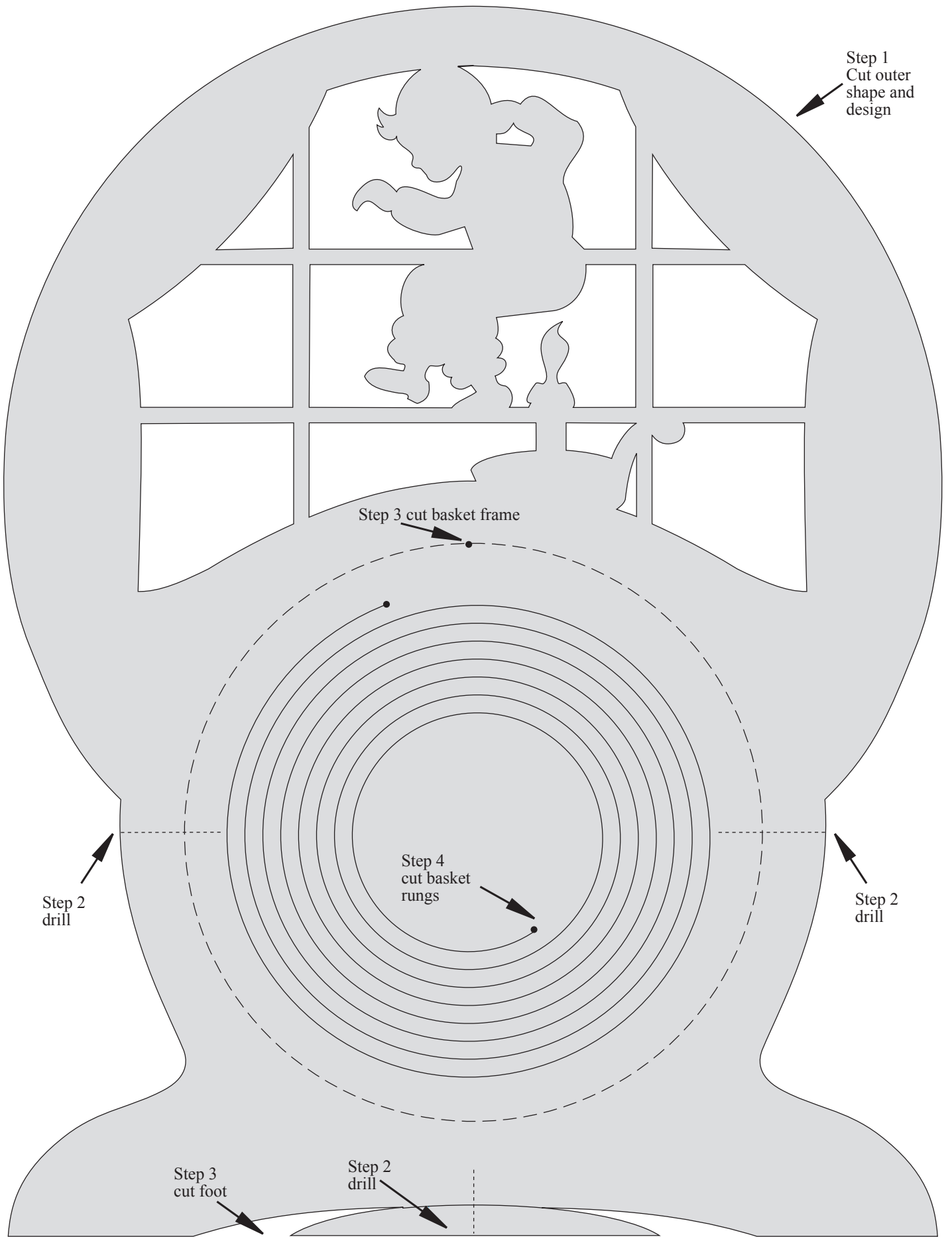

Step 1
Cut outer
shape and
design

Step 3 cut basket frame

Step 2
drill

Step 4
cut basket
rungs

Step 2
drill

Step 3
cut foot

Step 2
drill

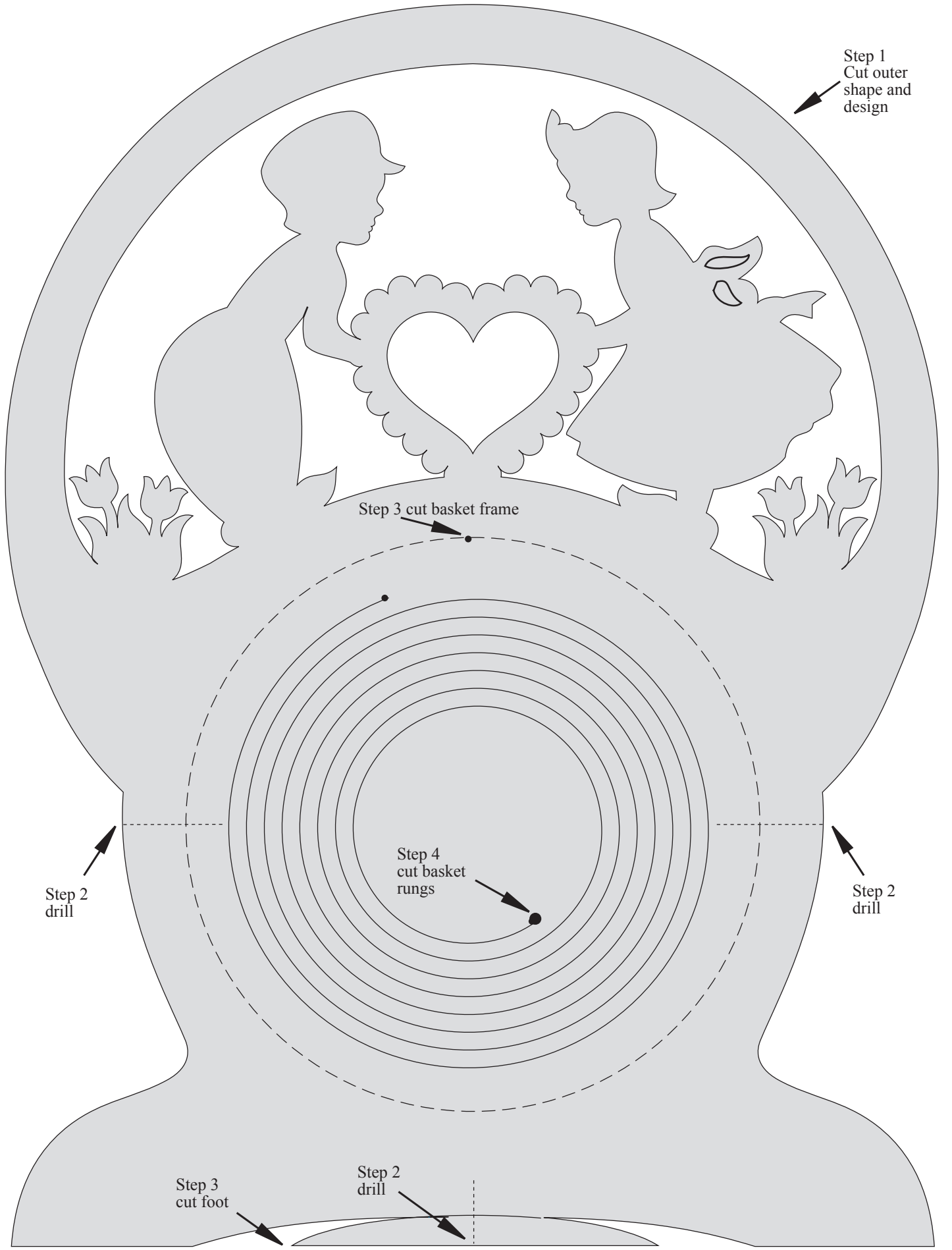

Step 1
Cut outer
shape and
design

Step 3 cut basket frame

Step 4
cut basket
rungs

Step 2
drill

Step 2
drill

Step 3
cut foot

Step 2
drill

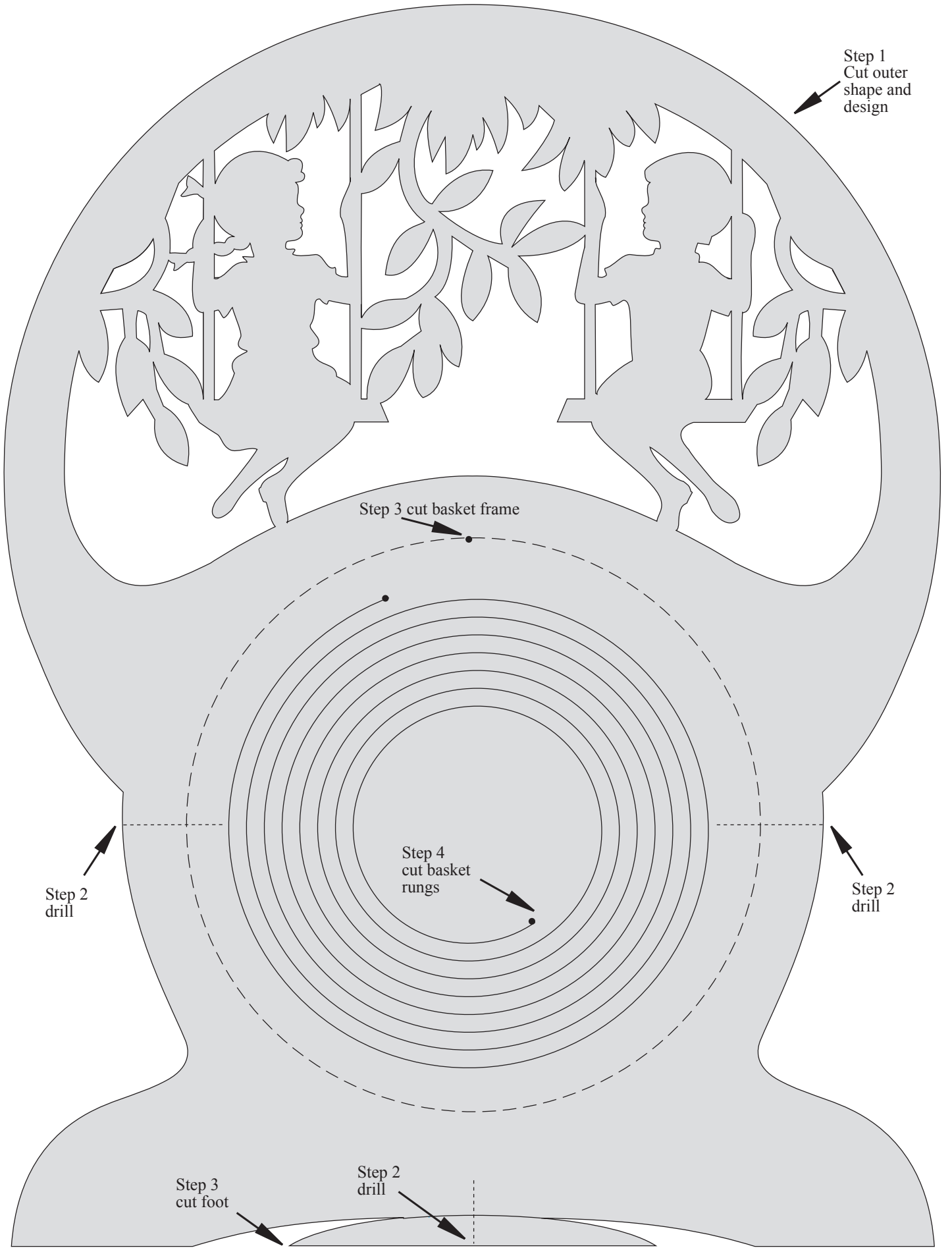

Step 1
Cut outer
shape and
design

Step 3 cut basket frame

Step 2
drill

Step 4
cut basket
rungs

Step 2
drill

Step 3
cut foot

Step 2
drill

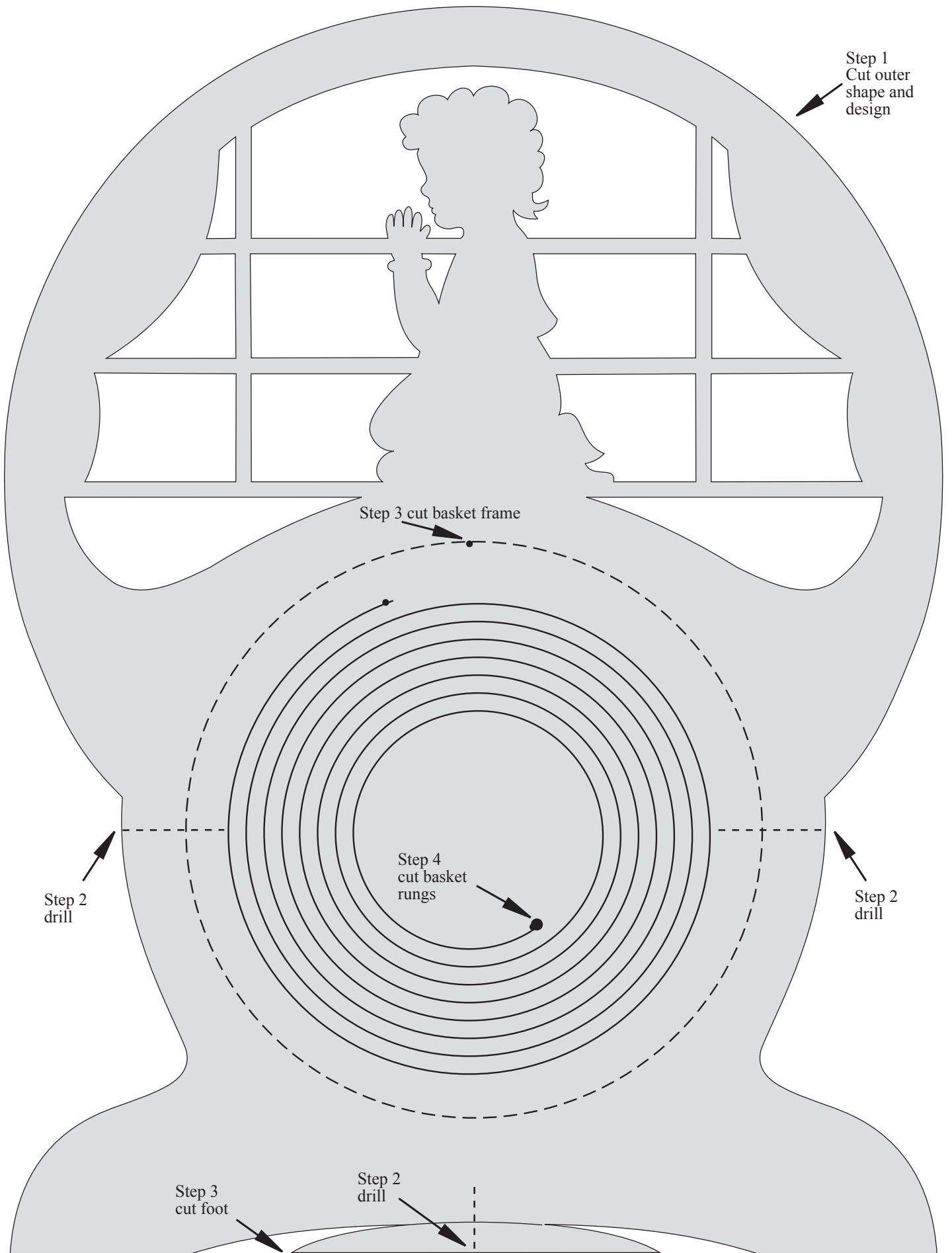

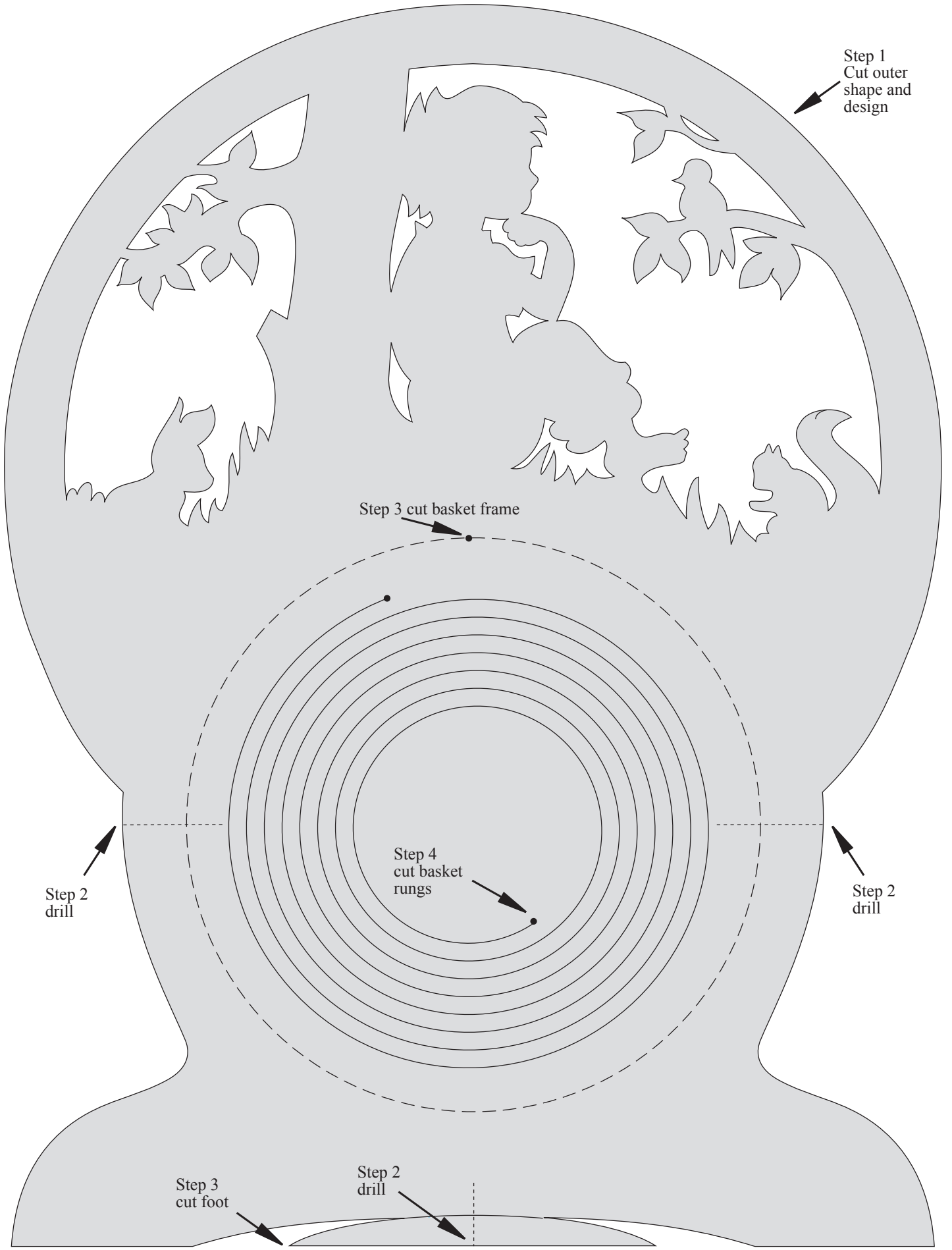

Step 1
Cut outer
shape and
design

Step 3 cut basket frame

Step 2
drill

Step 2
drill

Step 4
cut basket
rungs

Step 3
cut foot

Step 2
drill

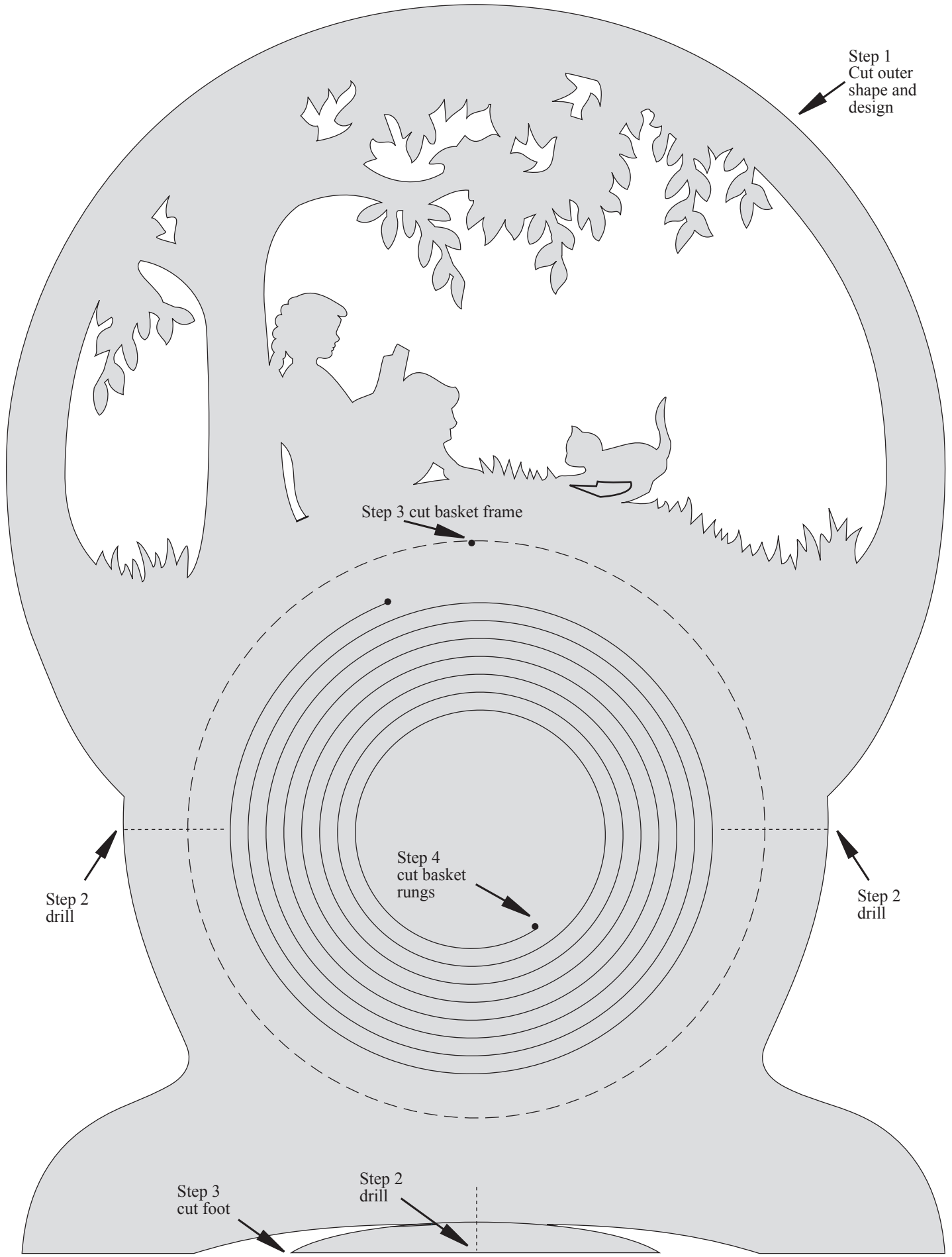

Step 1
Cut outer
shape and
design

Step 3 cut basket frame

Step 4
cut basket
rungs

Step 2
drill

Step 2
drill

Step 3
cut foot

Step 2
drill

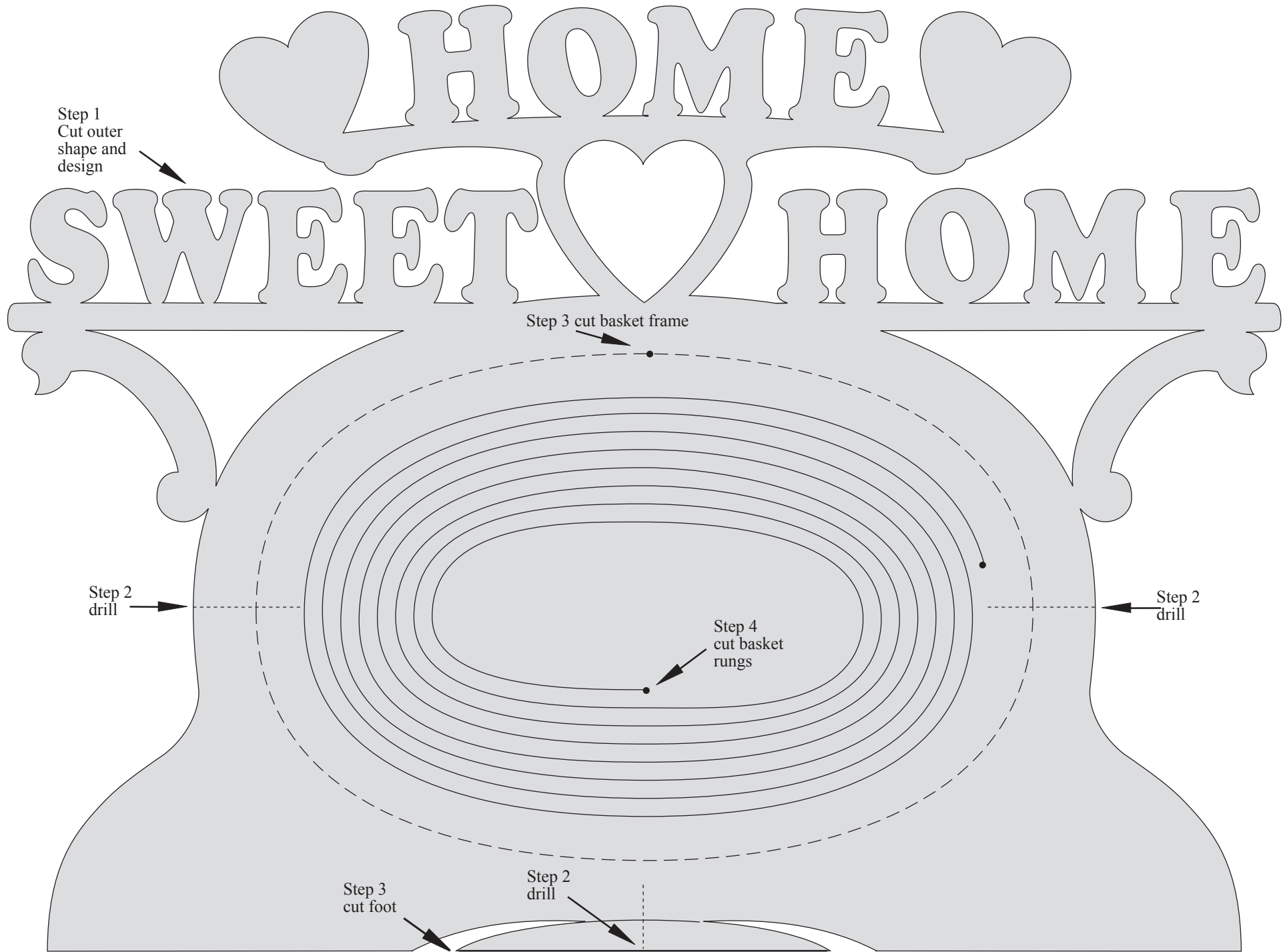

Step 1
Cut outer
shape and
design

Step 3 cut basket frame

Step 2
drill

Step 2
drill

Step 4
cut basket
rungs

Step 3
cut foot

Step 2
drill

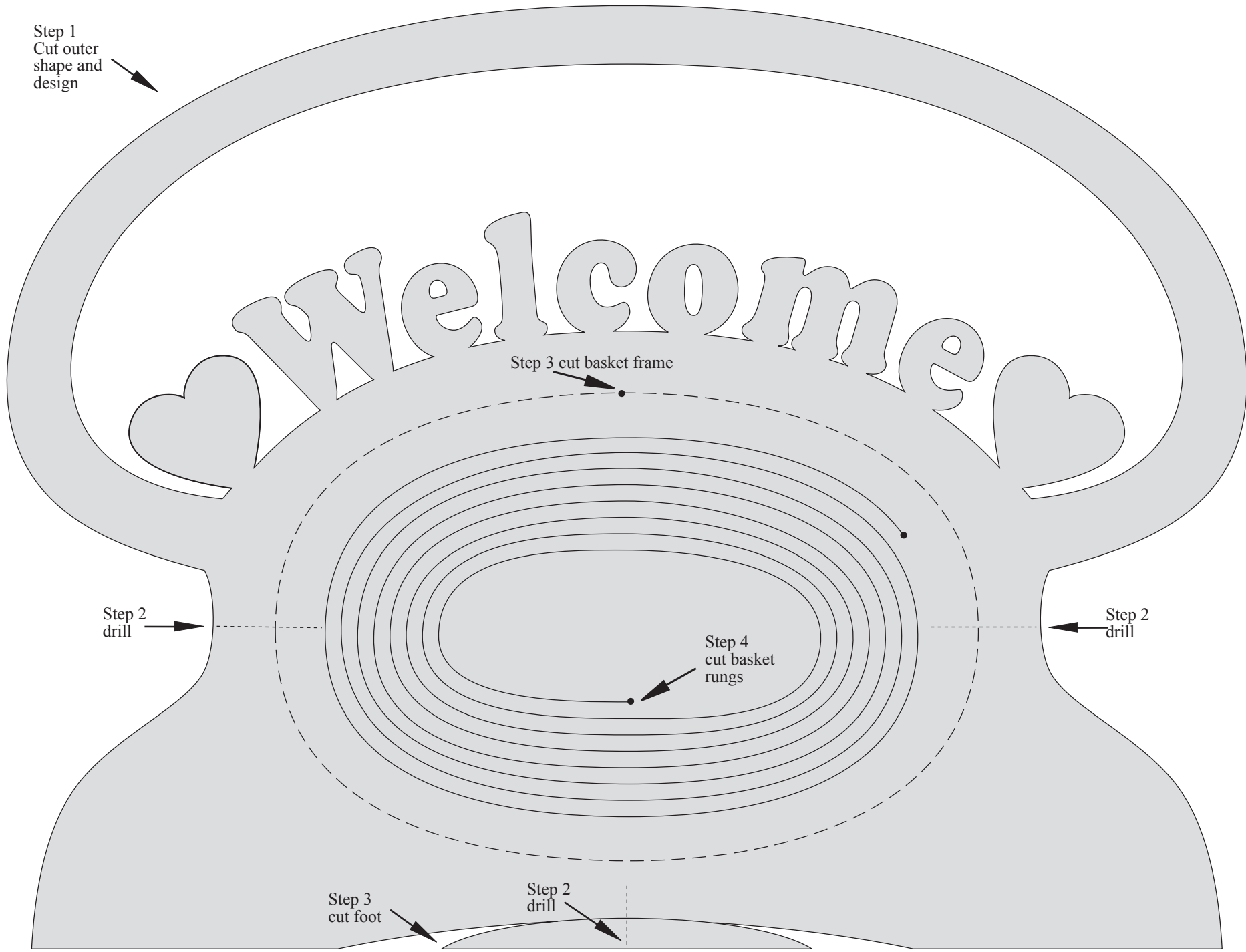

Step 1
Cut outer
shape and
design

Step 3 cut basket frame

Step 2
drill

Step 2
drill

Step 4
cut basket
rungs

Step 3
cut foot

Step 2
drill

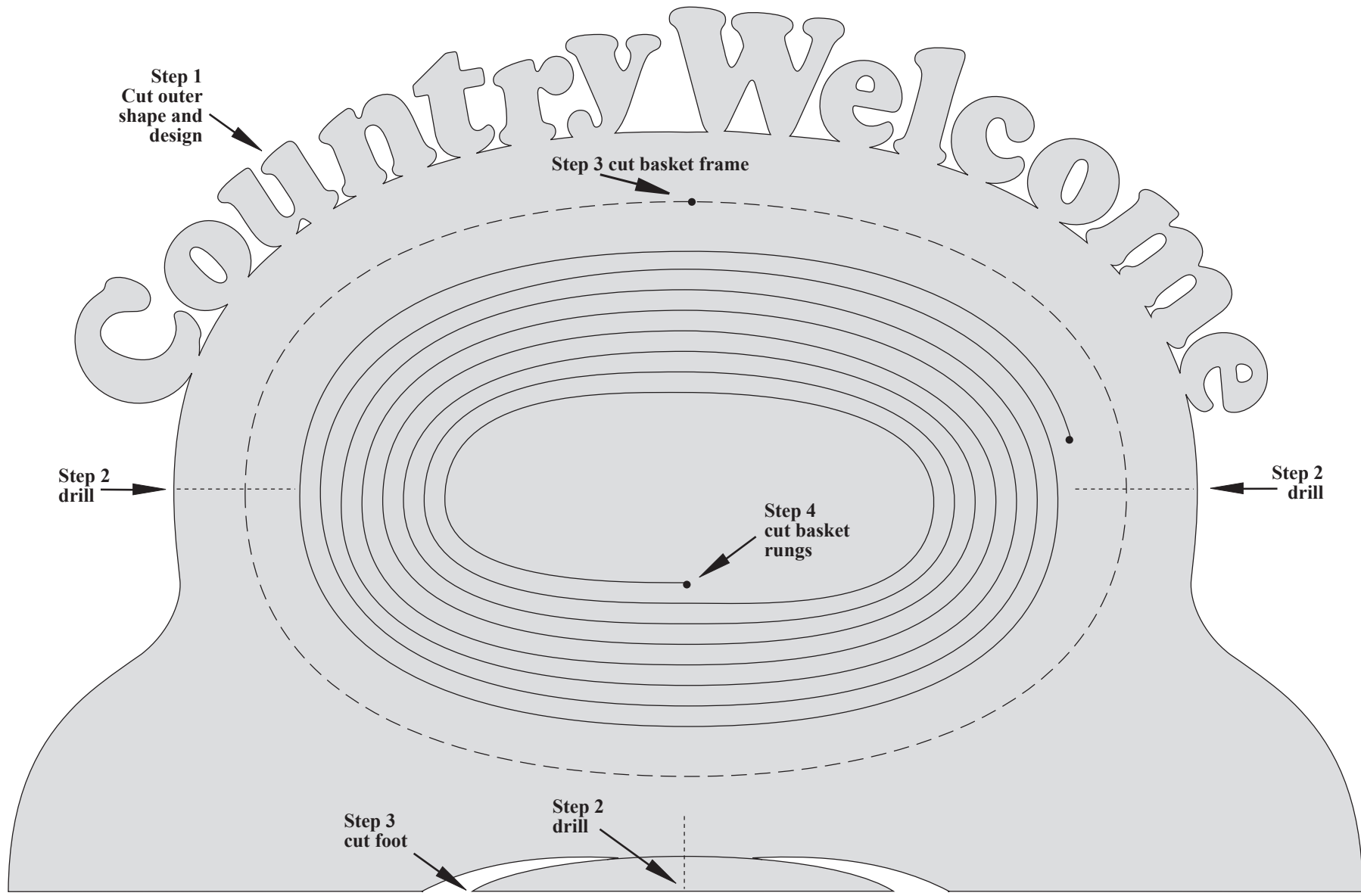

Step 1
Cut outer
shape and
design

Step 3 cut basket frame

Step 2
drill

Step 2
drill

Step 4
cut basket
rungs

Step 3
cut foot

Step 2
drill

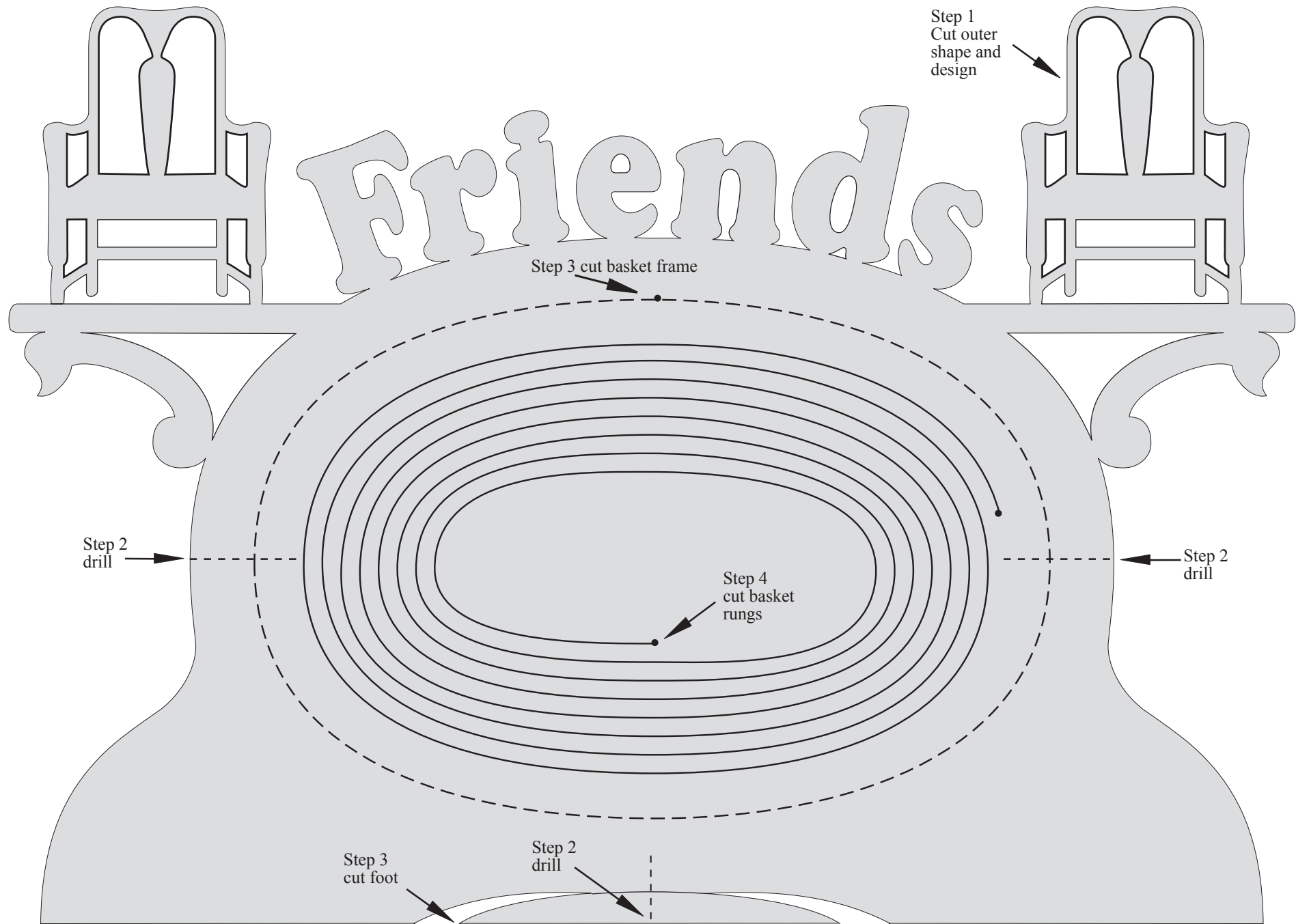

Step 1
Cut outer
shape and
design

Friends

Step 3 cut basket frame

Step 2
drill

Step 2
drill

Step 4
cut basket
rungs

Step 3
cut foot

Step 2
drill

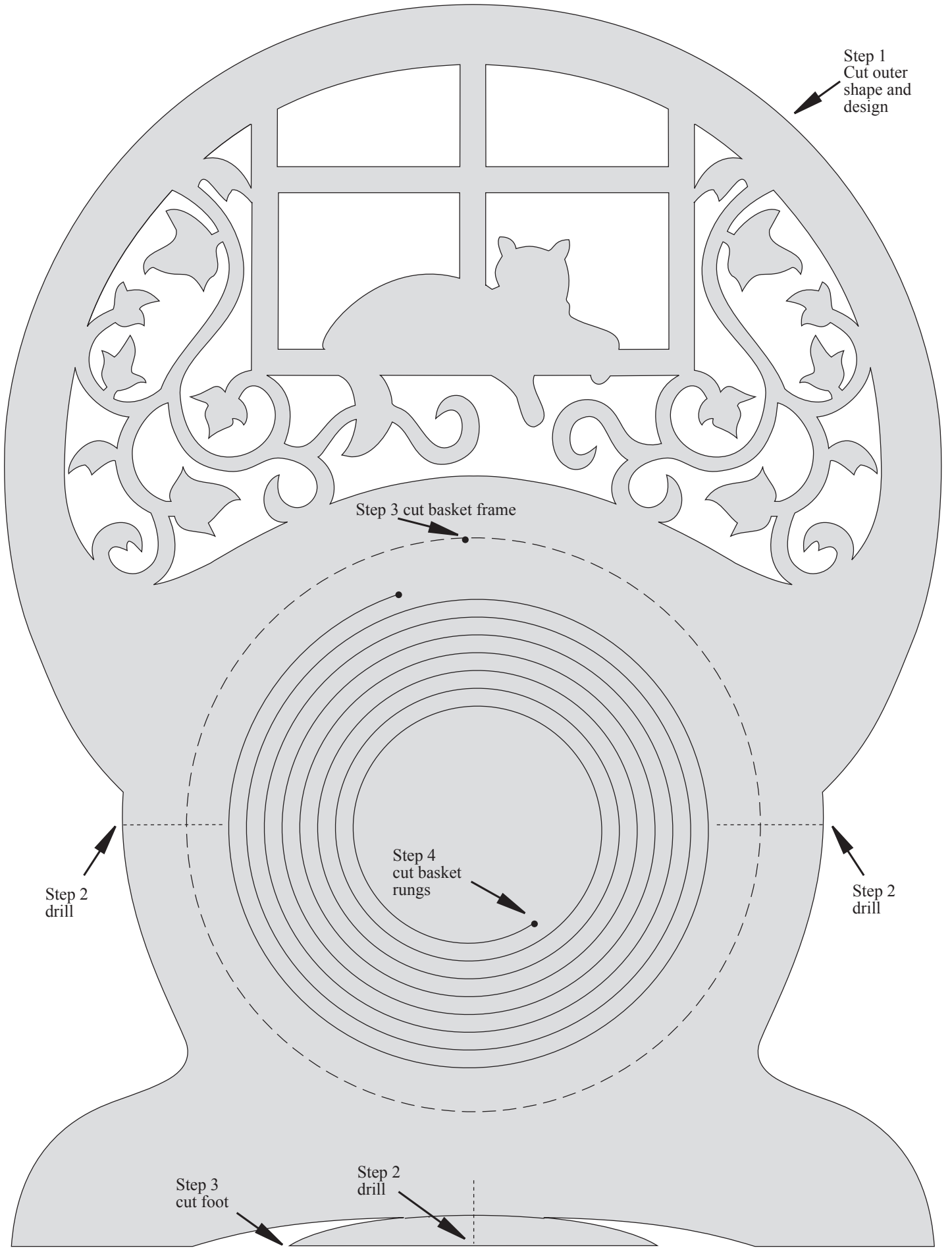

Step 1
Cut outer
shape and
design

Step 3 cut basket frame

Step 2
drill

Step 2
drill

Step 4
cut basket
rungs

Step 3
cut foot

Step 2
drill

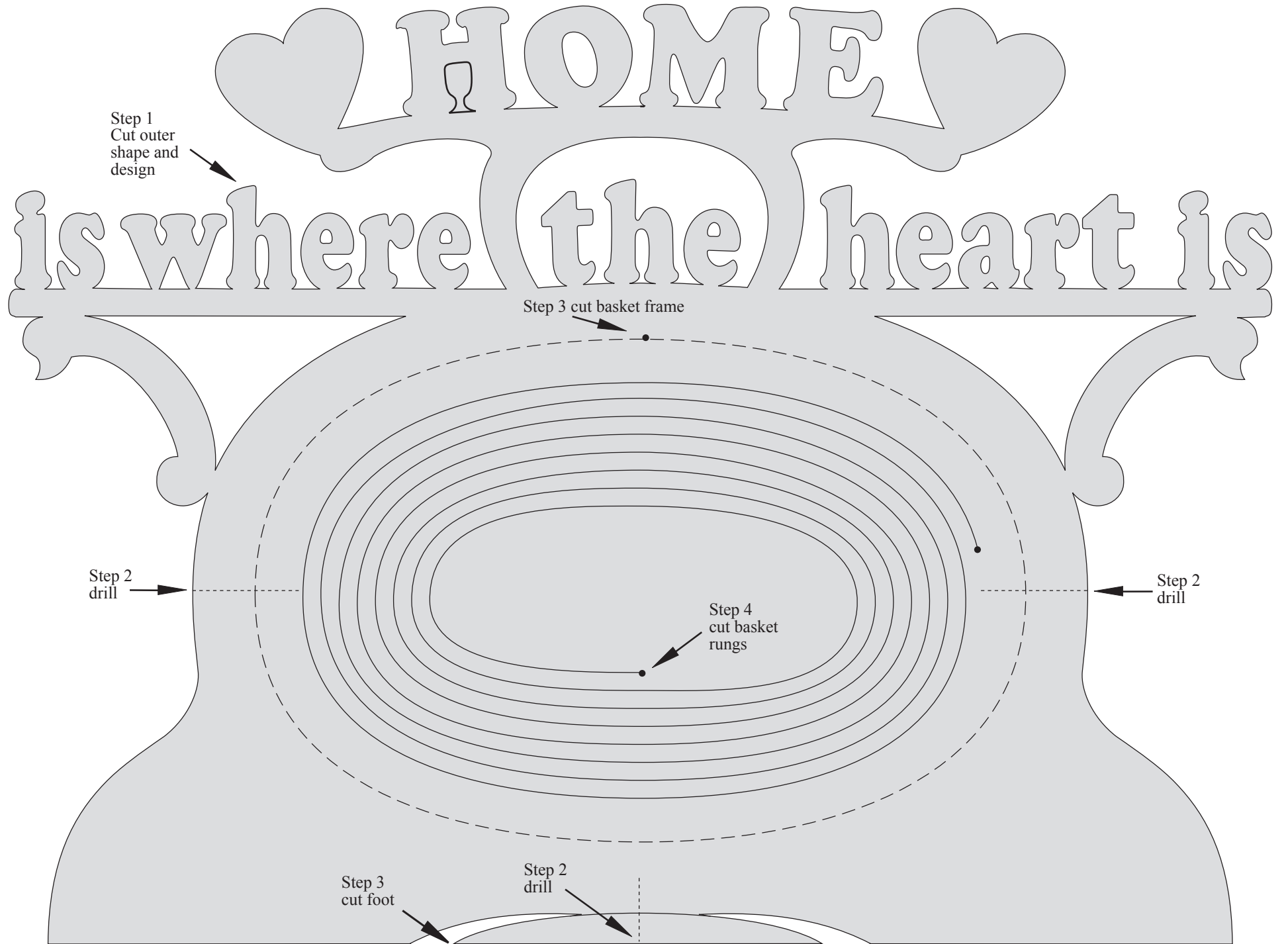

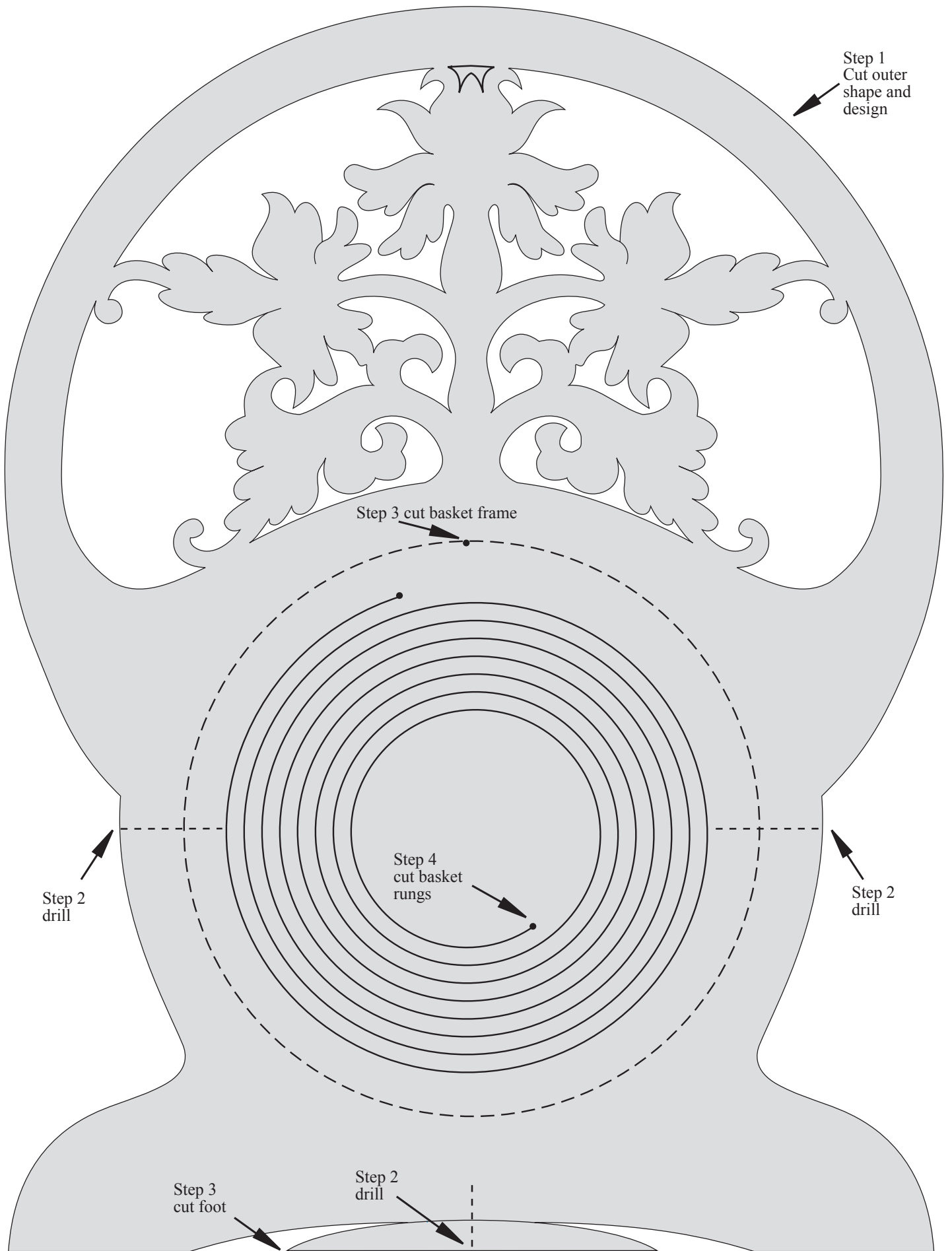

Step 1
Cut outer
shape and
design

Step 3 cut basket frame

Step 2
drill

Step 2
drill

Step 4
cut basket
rungs

Step 3
cut foot

Step 2
drill

Step 1
Cut outer
shape and
design



Step 3 cut basket frame

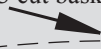

Step 2
drill



Step 2
drill



Step 4
cut basket
rungs



Step 3
cut foot



Step 2
drill

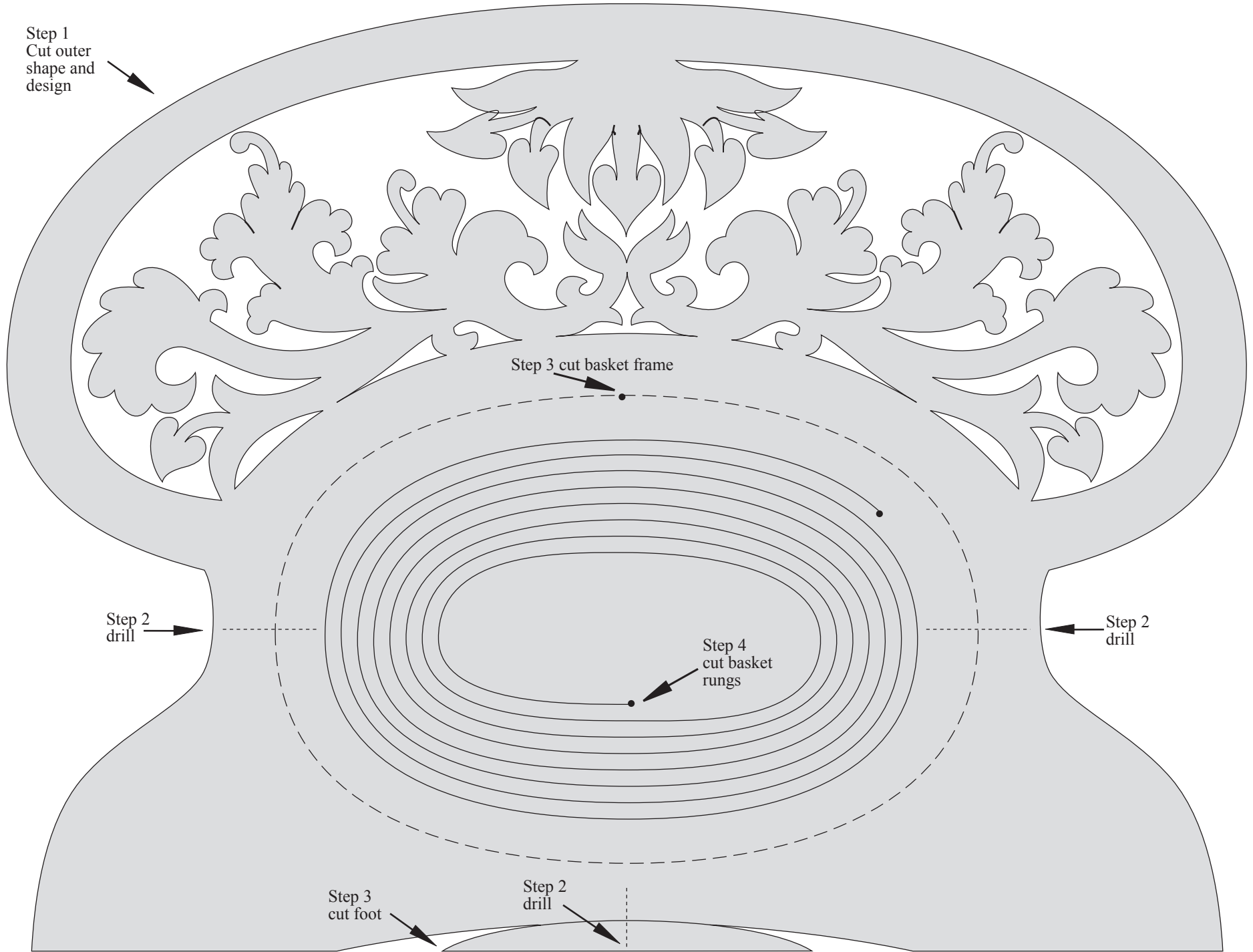

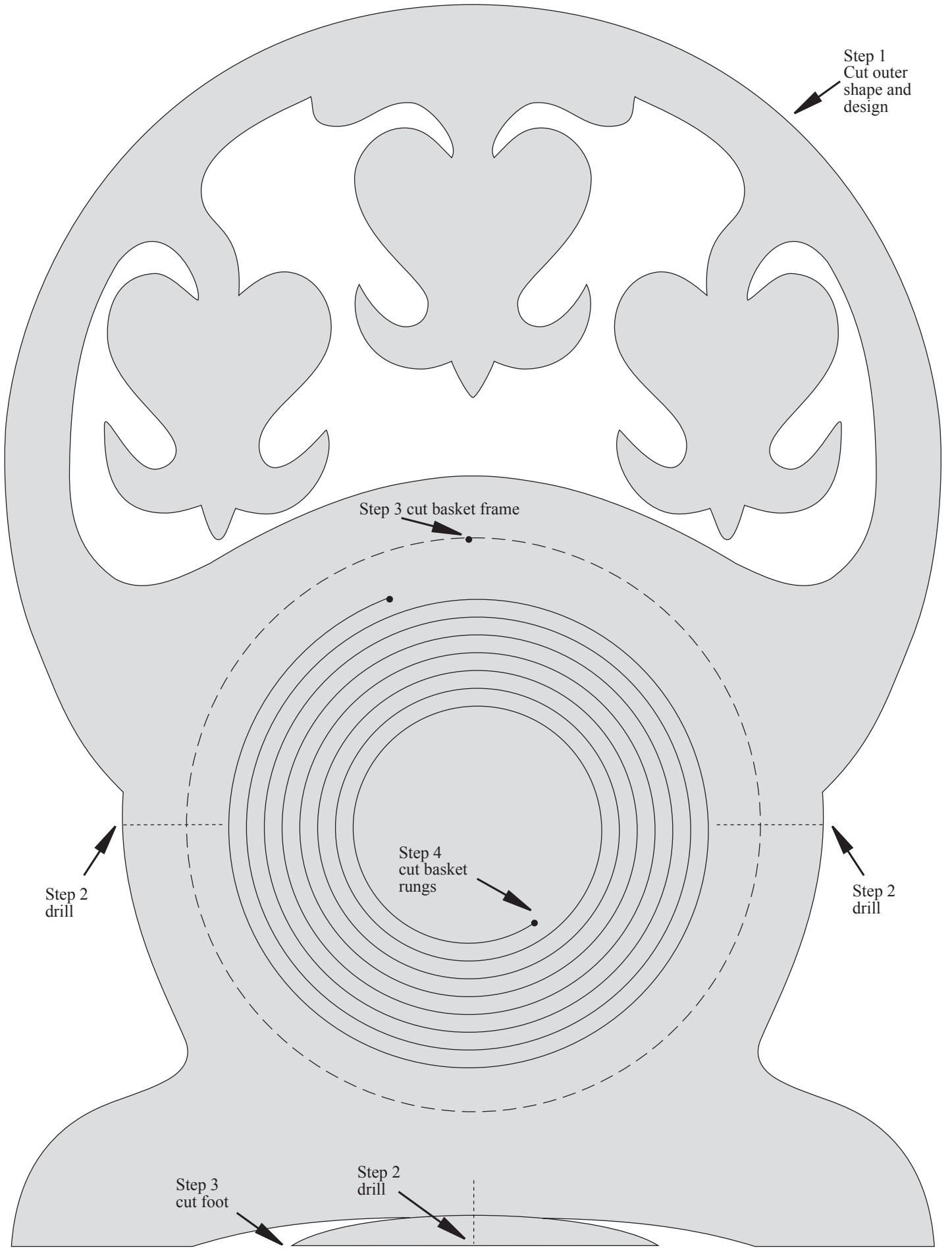

Step 1
Cut outer
shape and
design

Step 3 cut basket frame

Step 2
drill

Step 2
drill

Step 4
cut basket
rungs

Step 3
cut foot

Step 2
drill

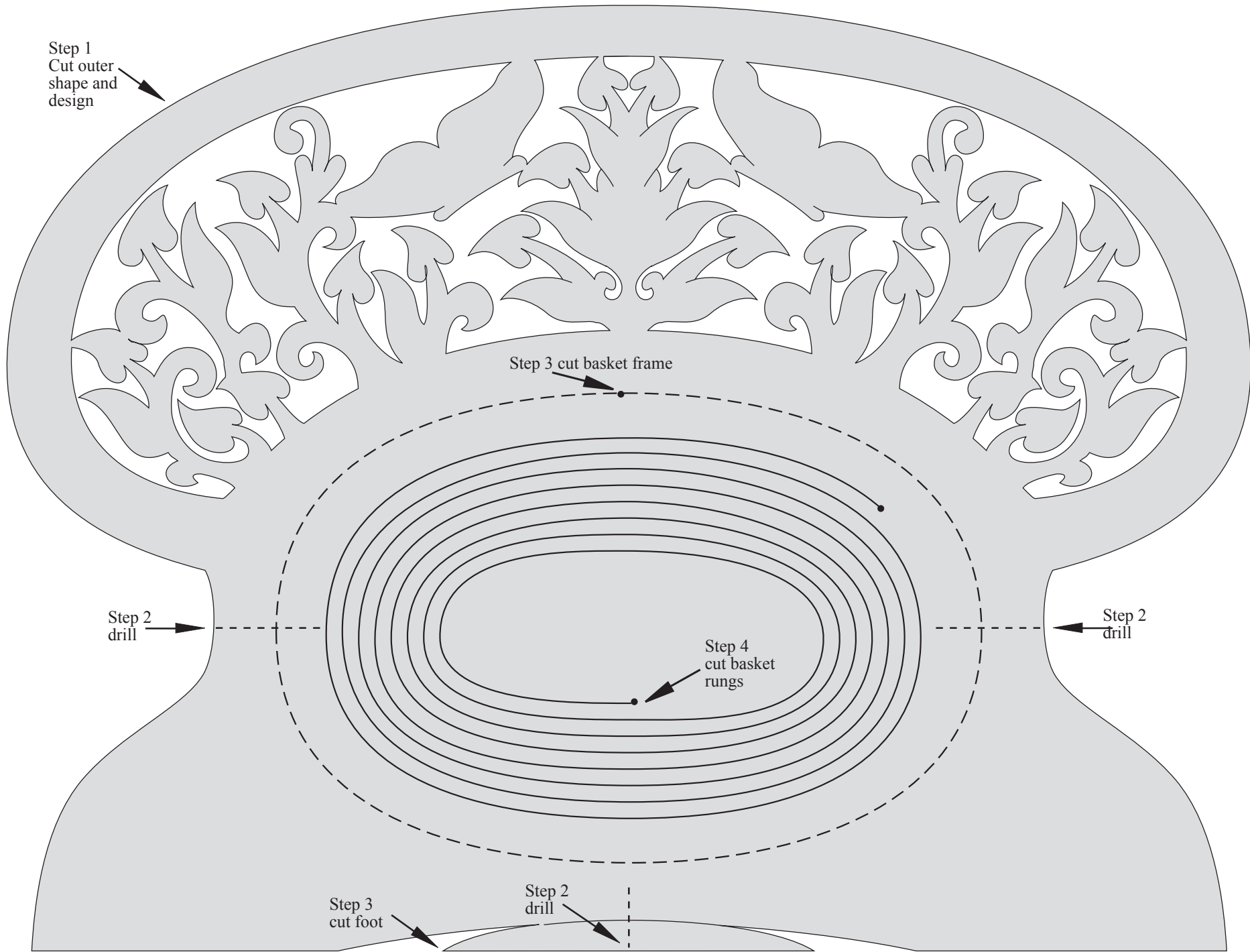

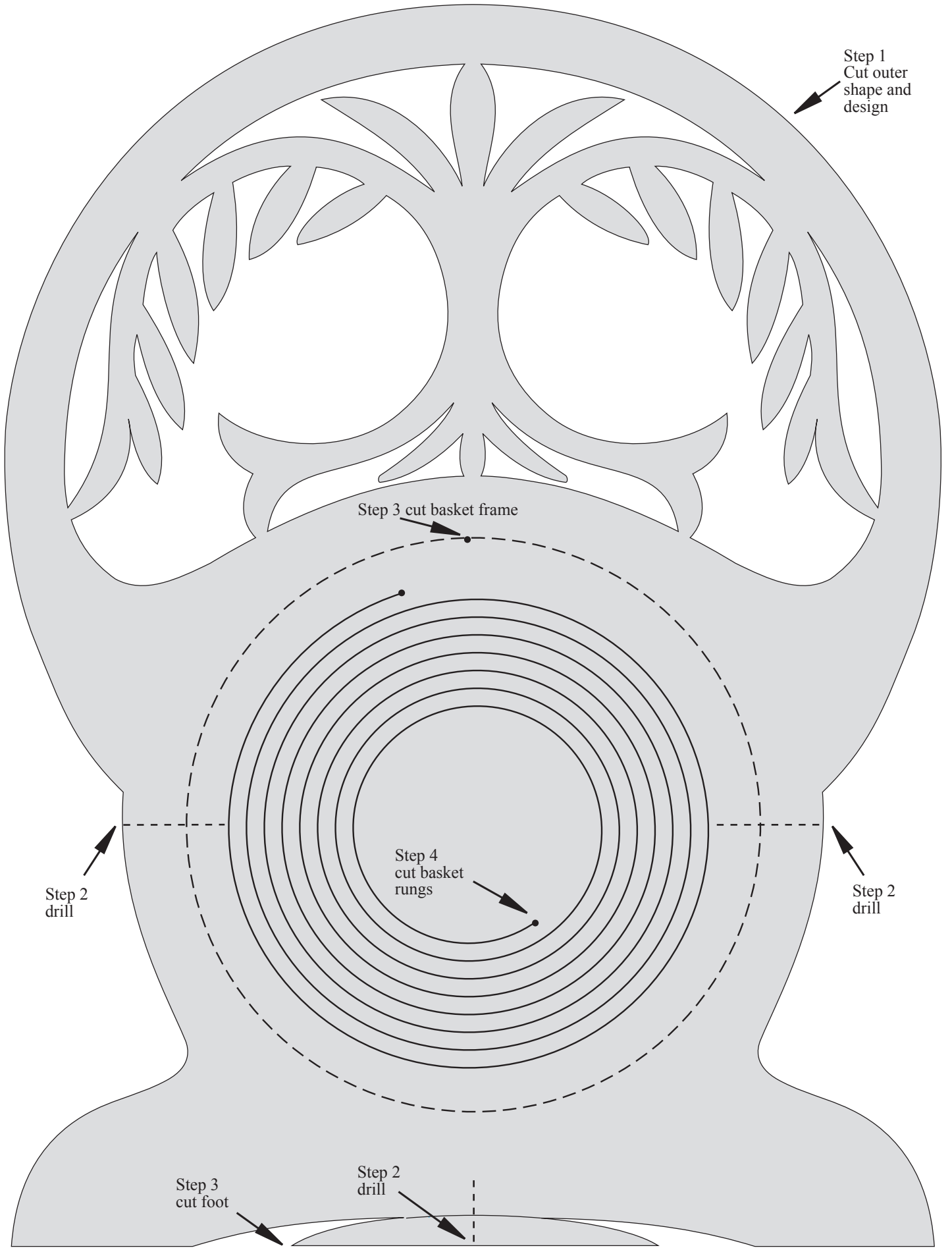

Step 1
Cut outer
shape and
design

Step 3 cut basket frame

Step 2
drill

Step 2
drill

Step 4
cut basket
rungs

Step 3
cut foot

Step 2
drill

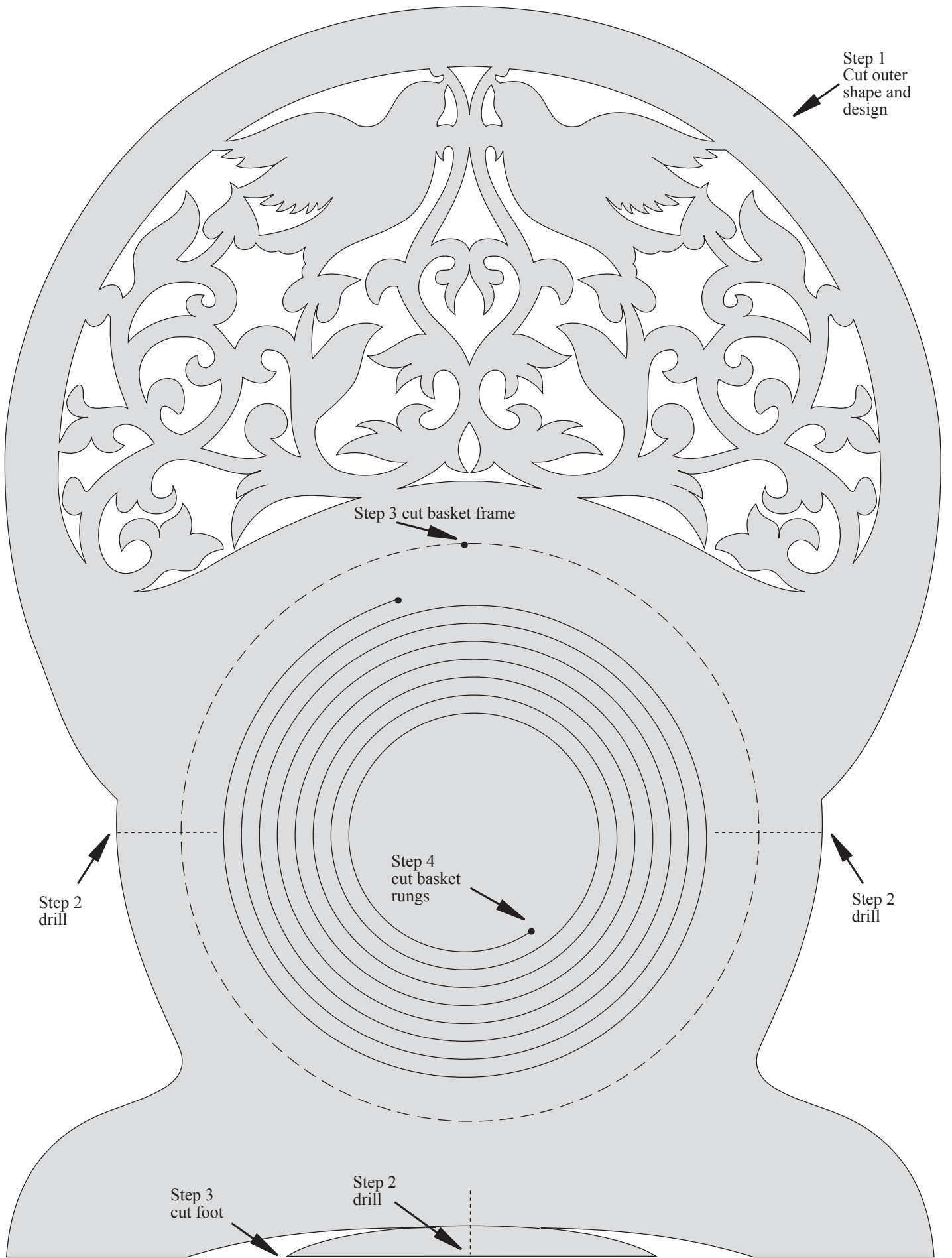

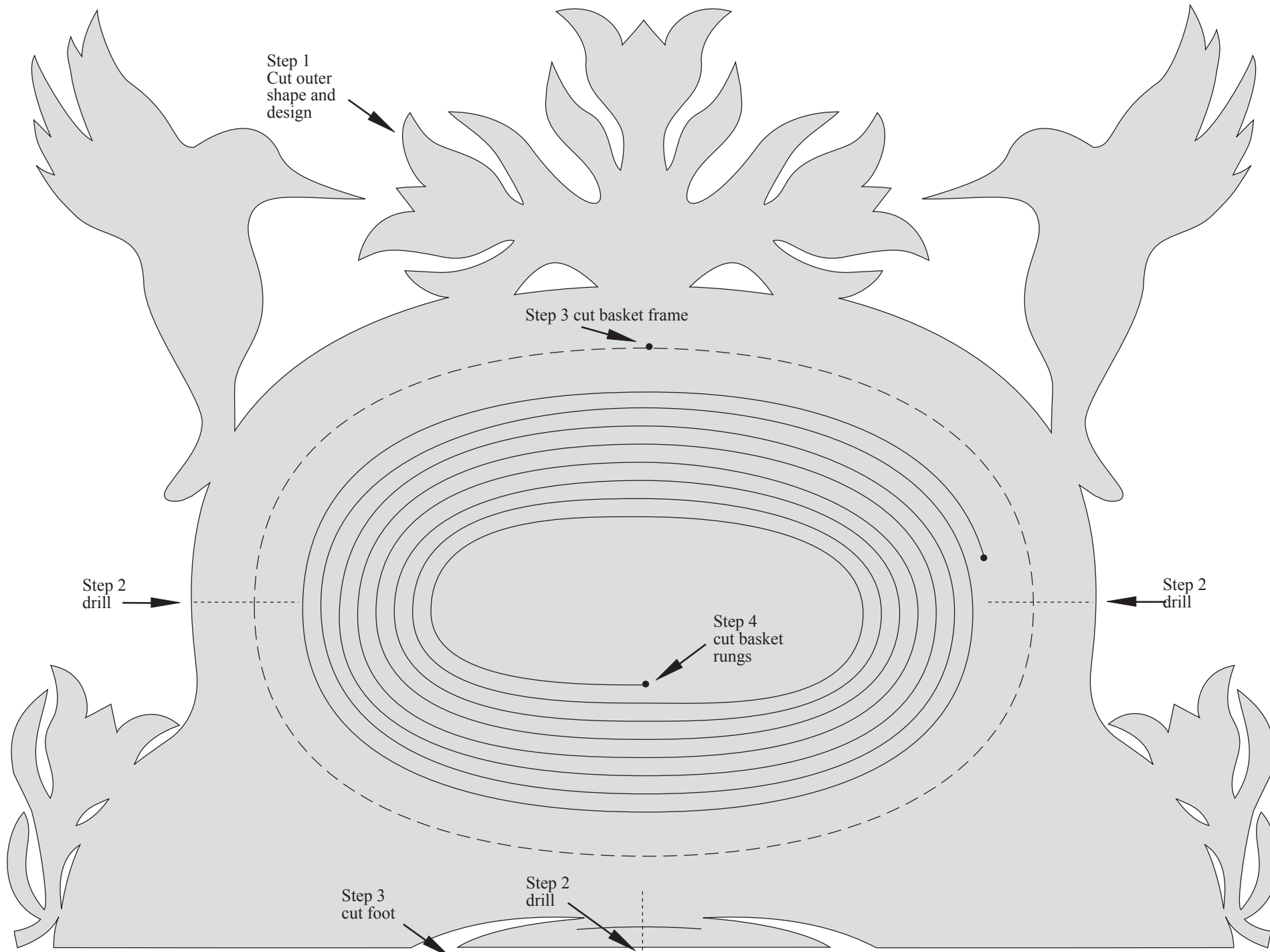

Step 1
Cut outer
shape and
design

Step 3 cut basket frame

Step 2
drill

Step 2
drill

Step 4
cut basket
rungs

Step 3
cut foot

Step 2
drill

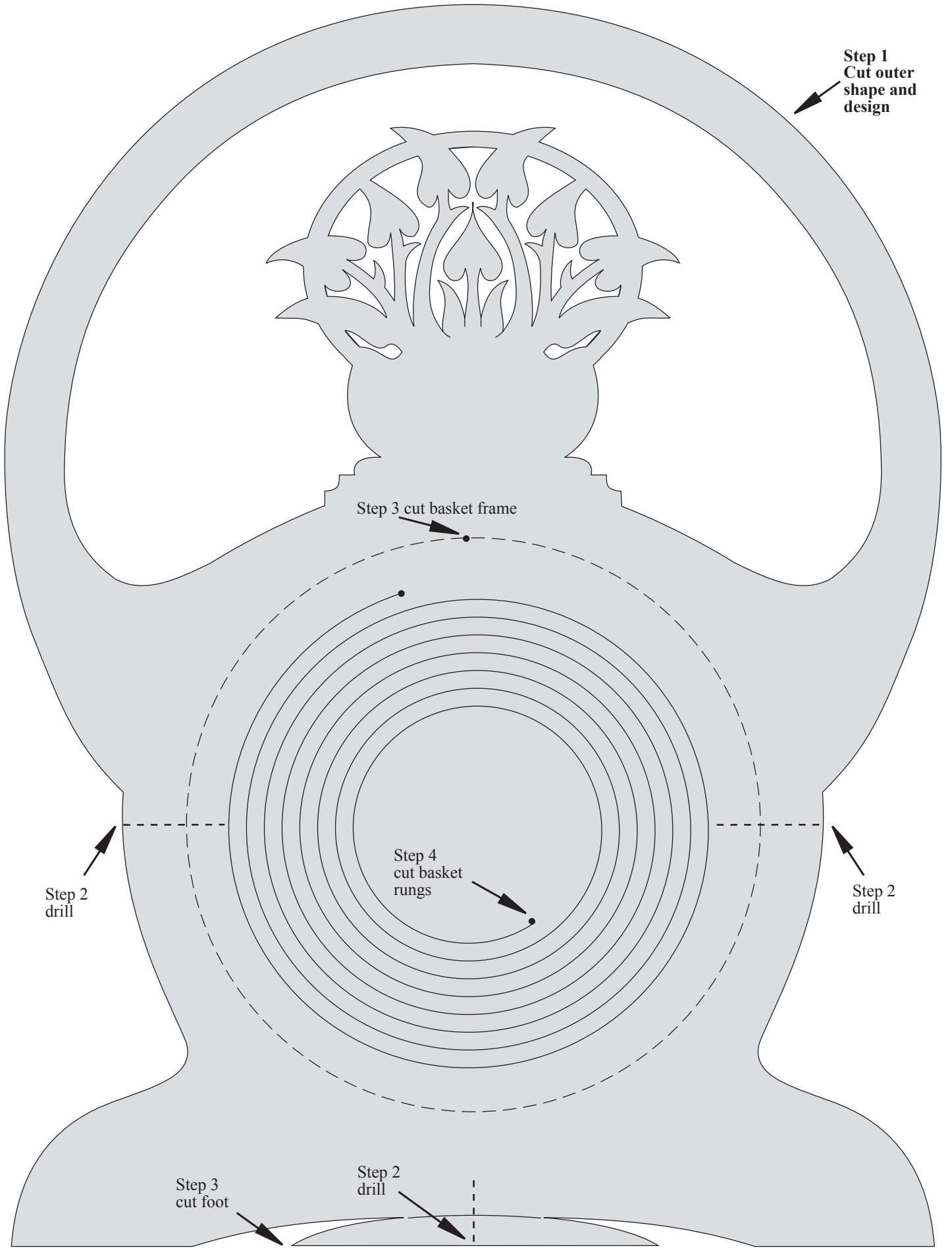

Step 1
Cut outer
shape and
design

Step 3 cut basket frame

Step 2
drill

Step 2
drill

Step 4
cut basket
rungs

Step 3
cut foot

Step 2
drill

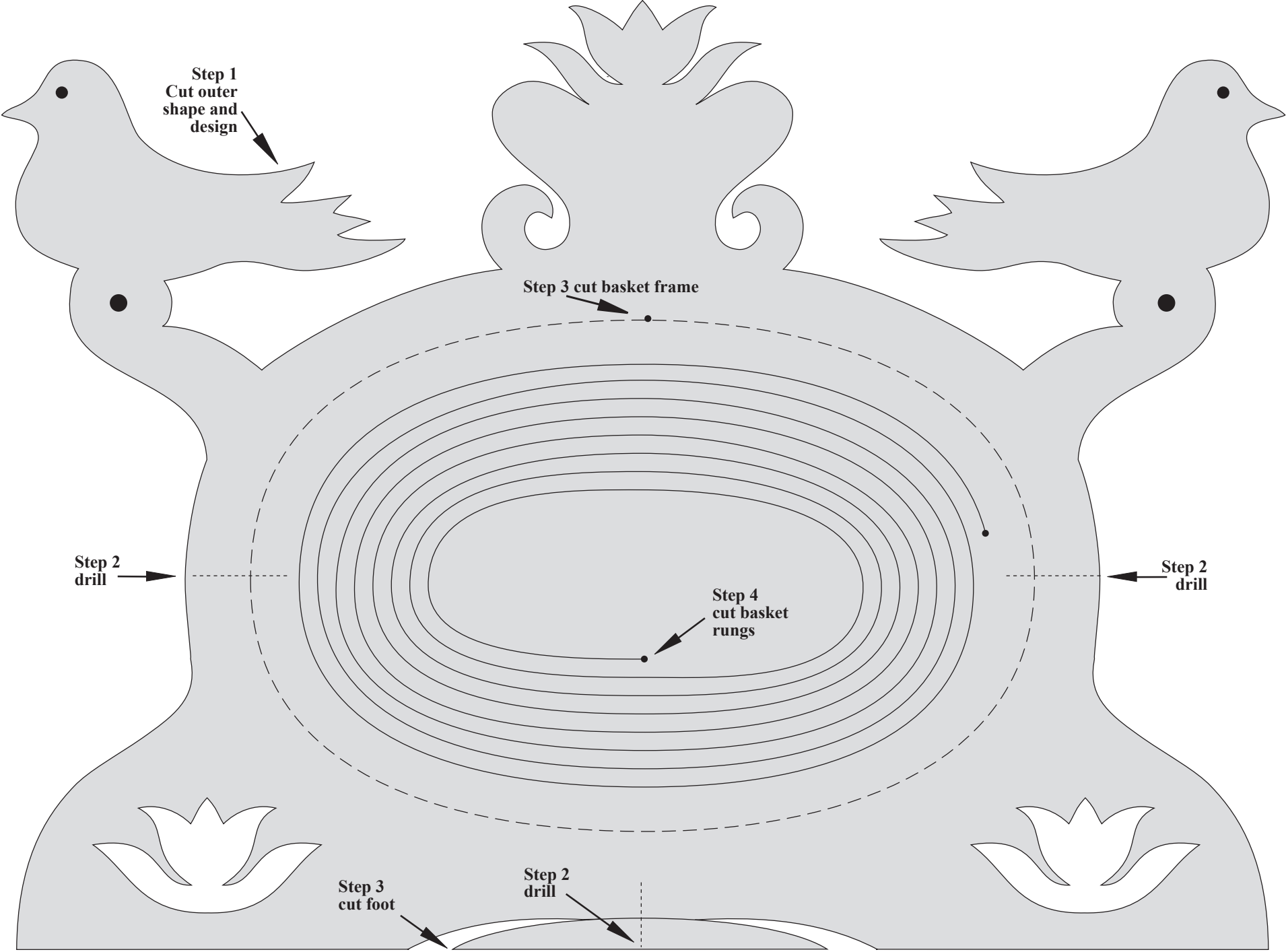

Step 1
Cut outer
shape and
design

Step 3 cut basket frame

Step 2
drill

Step 2
drill

Step 4
cut basket
rungs

Step 3
cut foot

Step 2
drill

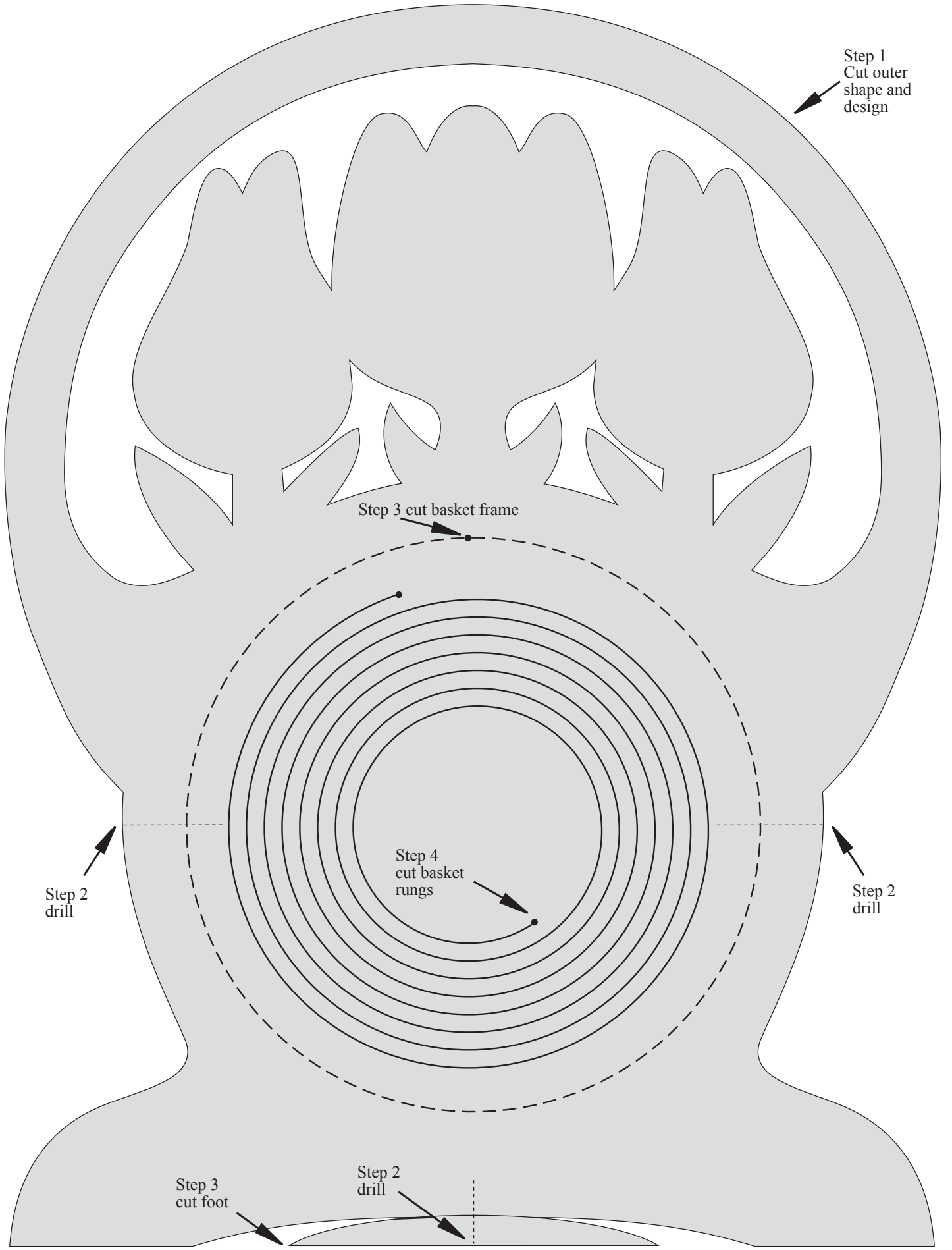

Step 1
Cut outer
shape and
design

Step 3 cut basket frame

Step 4
cut basket
rungs

Step 2
drill

Step 2
drill

Step 3
cut foot

Step 2
drill

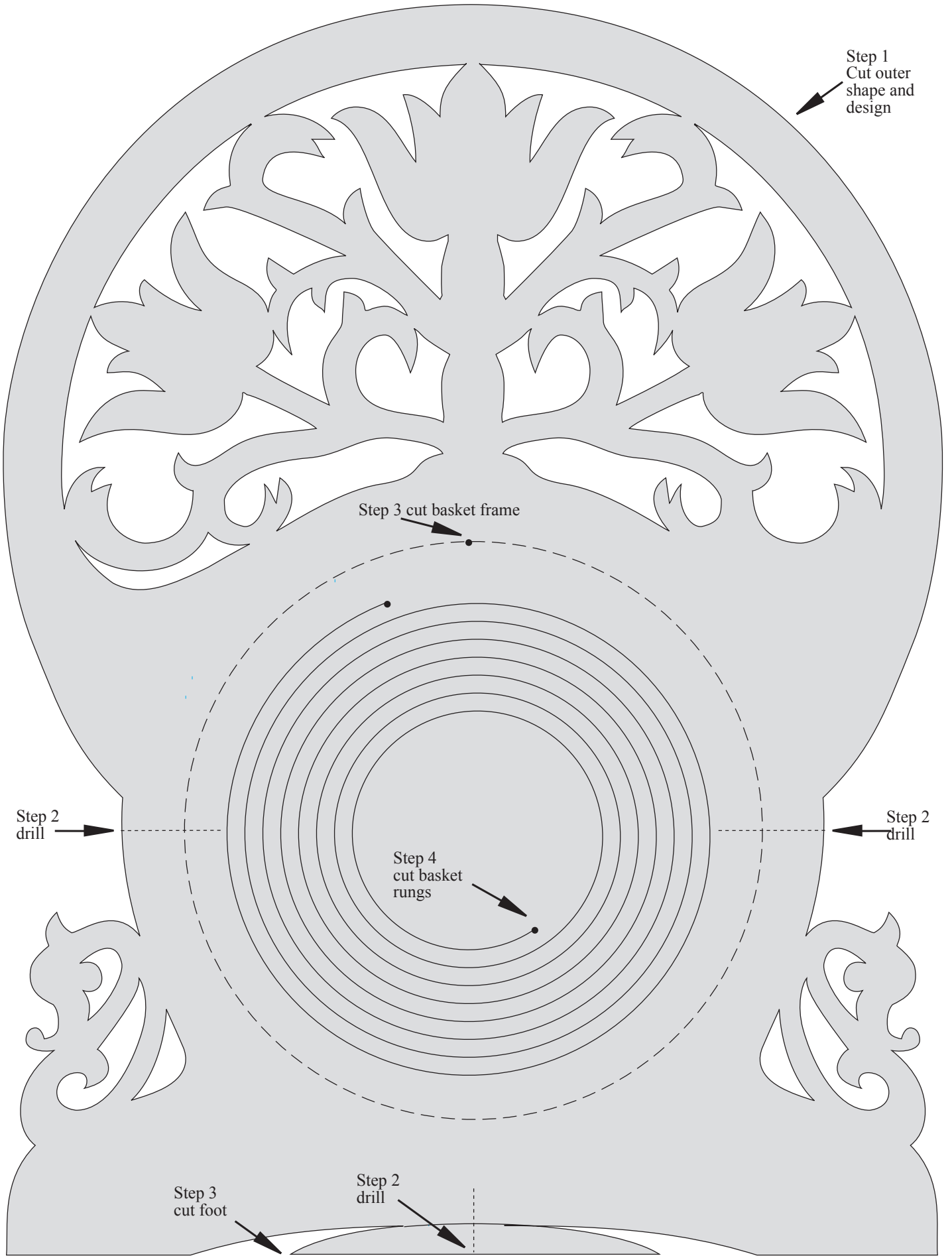

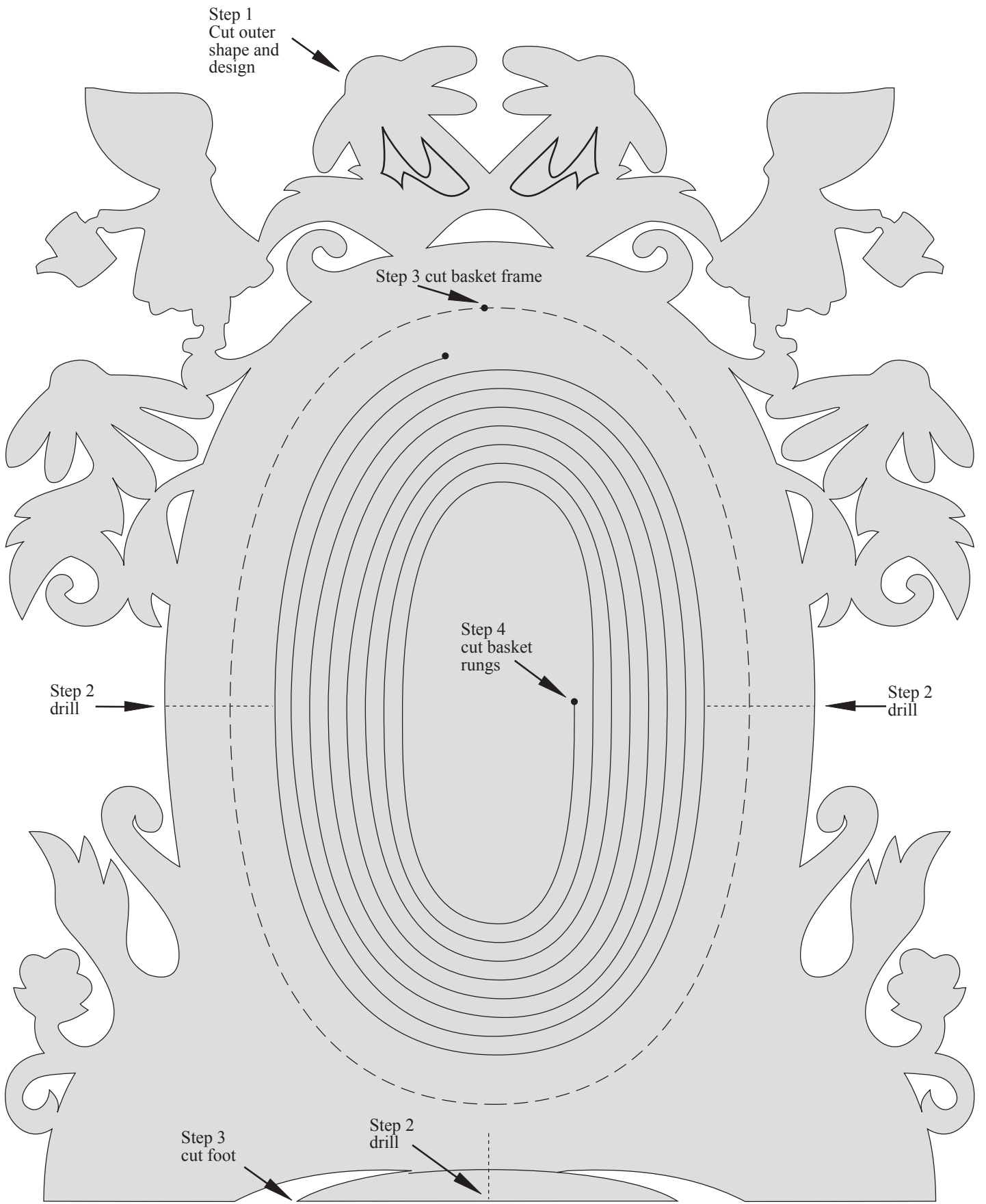

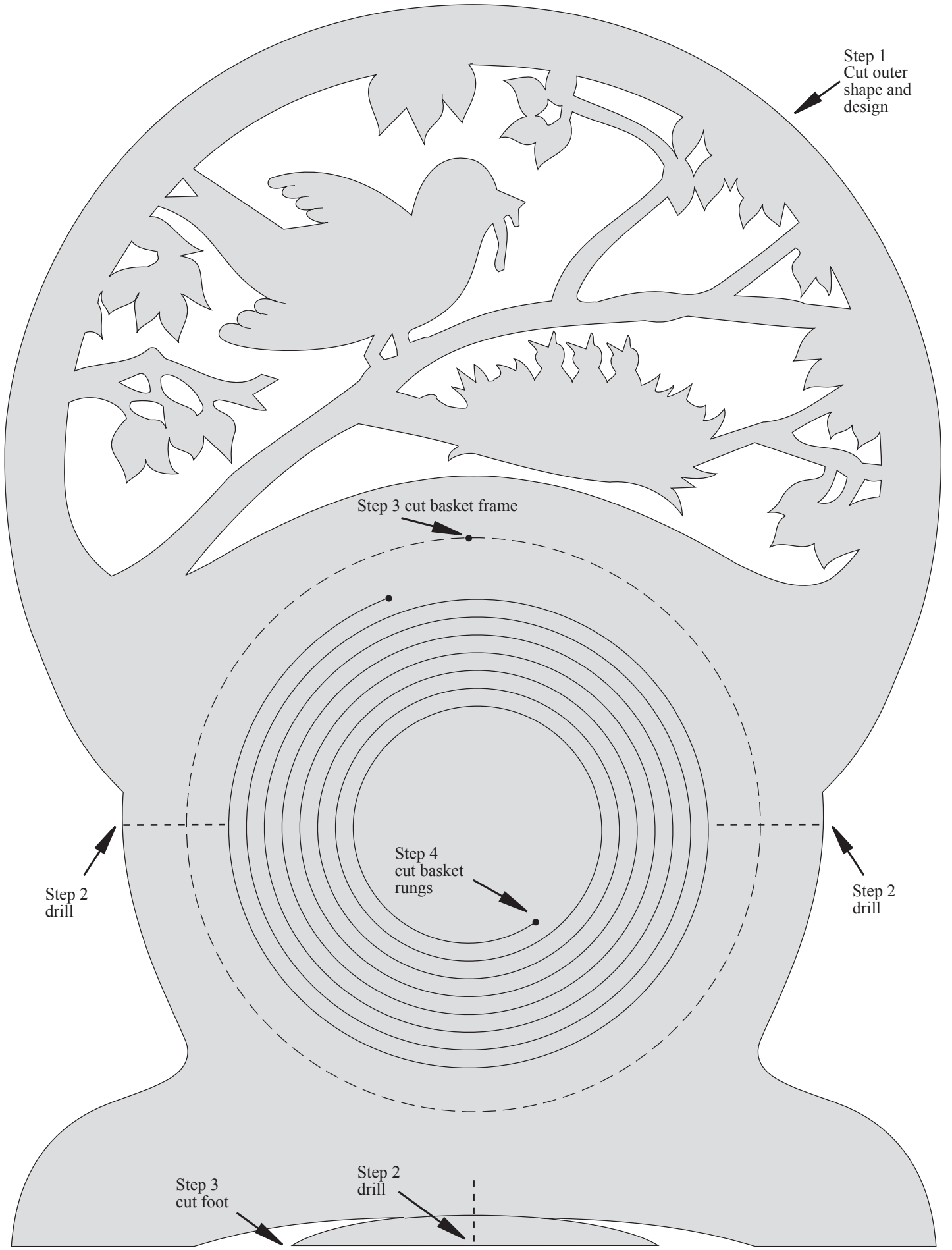

Step 1
Cut outer
shape and
design

Step 3 cut basket frame

Step 4
cut basket
rungs

Step 2
drill

Step 2
drill

Step 3
cut foot

Step 2
drill

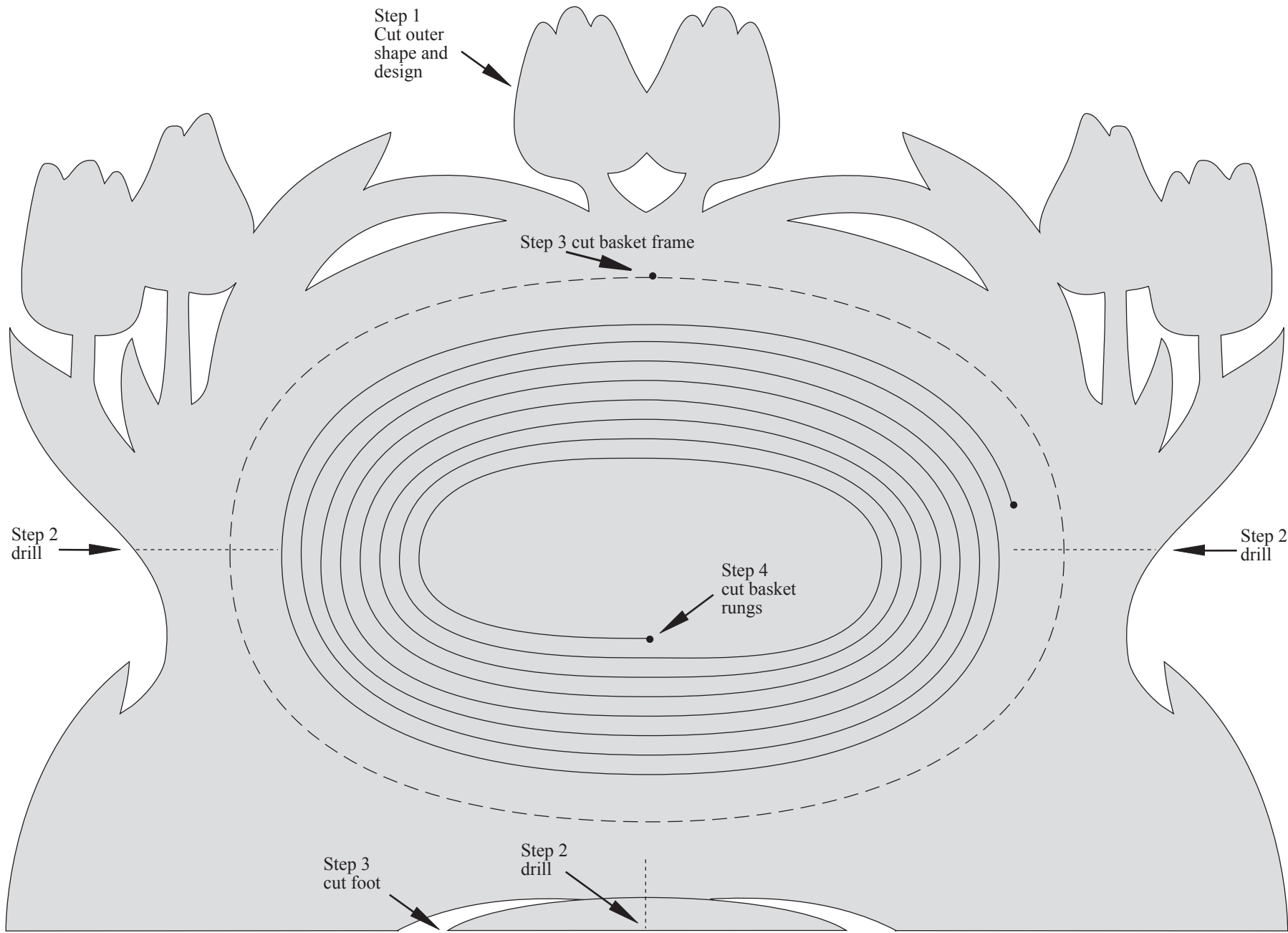

Step 1
Cut outer
shape and
design

Step 3 cut basket frame

Step 2
drill

Step 2
drill

Step 4
cut basket
rungs

Step 3
cut foot

Step 2
drill

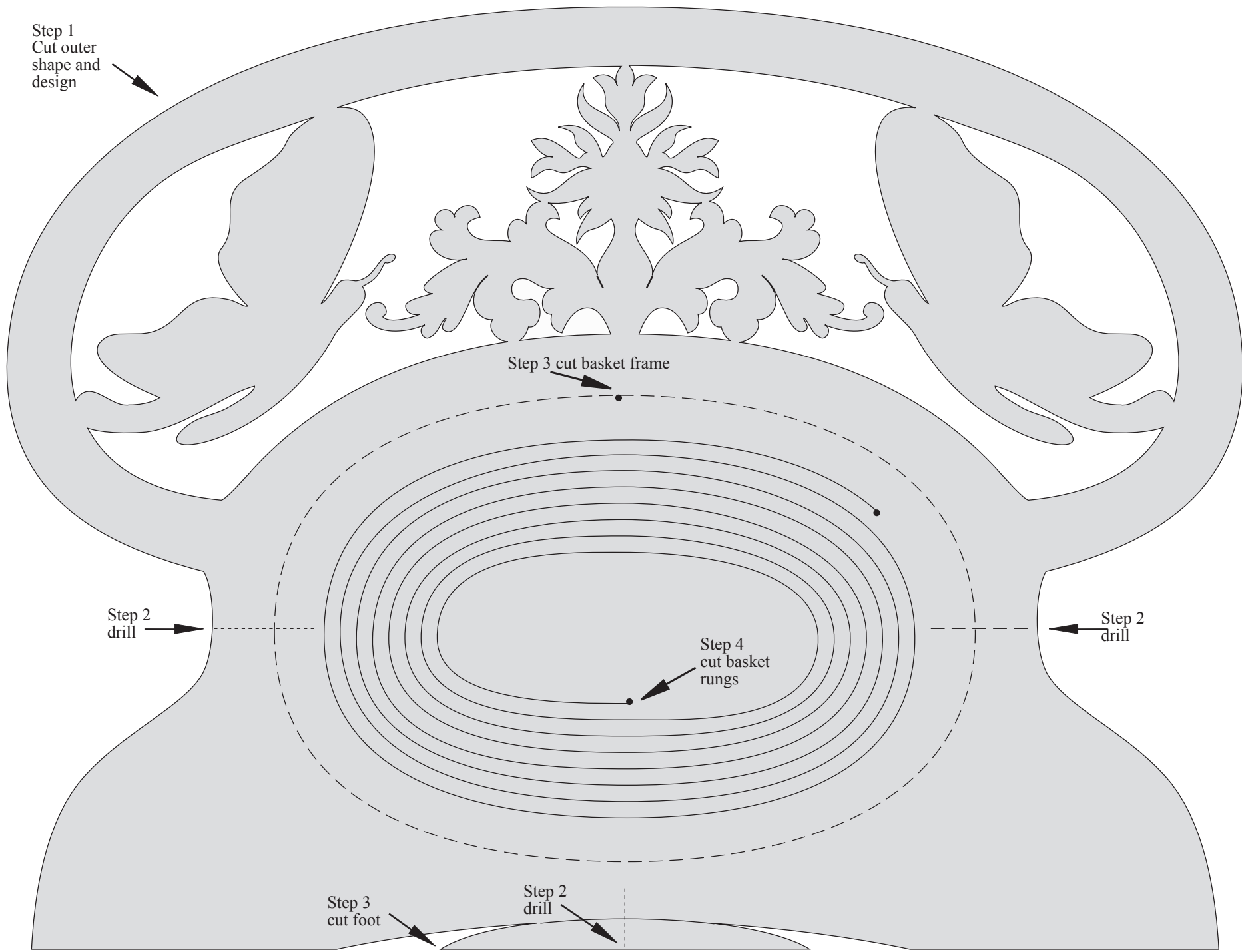

Step 1
Cut outer
shape and
design

Step 3 cut basket frame

Step 2
drill

Step 2
drill

Step 4
cut basket
rungs

Step 3
cut foot

Step 2
drill