

ONDORI

# Basic Beadwork for Beginners



PATRICIA  
GIENISE GISE 4-5-97

O N D O R I S H A P U B L I S H E R S



FLOWERS AND FAIRIES 1

THE WIZARD OF OZ 4

ANNE'S ROOM 6

FOREST SYMPHONY 8

THE CIRCUS COMES TO TOWN 10

NEW YEAR'S 12

THE DOLL FESTIVAL 14

CHRISTMAS 16

GARDEN PARTY 18

INTERNATIONAL ANIMAL CONVENTION 22

RABBIT FAMILY 24

BEAR FAMILY 26

OCEAN PARADISE 28

NAME PLATE 30

MUSICAL PARADE 31

DRESS UP YOUR KITCHEN 32

SUMMER AT THE BEACH 34

COIN PURSE AND RINGS 36

PEARL ACCESSORIES 38

FLOWER ACCESSORIES 40

POUCH AND ACCESSORIES 42

BEAD BASICS 44

LAURA AND MARY 46

BASKET 47

POINTS TO REMEMBER 48



★Copyright © 1996 MITSUKO MUTO & ONDORISHA PUBLISHERS, LTD. All rights reserved.

★Published by ONDORISHA PUBLISHERS, LTD.,

11-11 Nishigoken-cho, Shinjuku-ku, Tokyo 162, Japan.

★Sole Overseas Distributor: Japan Publications Trading CO Ltd.

P. O. Box 5050 Tokyo International, Tokyo, Japan.

★Distributed

• in United States by Kodansha America, INC.

114 Fifth Avenue, New York, NY 10011, U.S.A.

• in British Isles & European Continent by Premier Book Marketing Ltd.,

1 Gower Street, London WC1E 6HA, England.

• in Australia by Bookwise International.

54 Crittenden Road, Findon, South Australia 5023, Australia.

10 9 8 7 6 5 4 3 2 1

ISBN 0-87040-972-7

Printed in Japan

# FLOWERS AND FAIRIES

After dancing in the sky, the fairies rest on Crystal Mountain.  
Dragonfly, butterfly and ladybug take a nap.



INSTRUCTIONS ON PAGE 2



## 8 BIG RABBIT

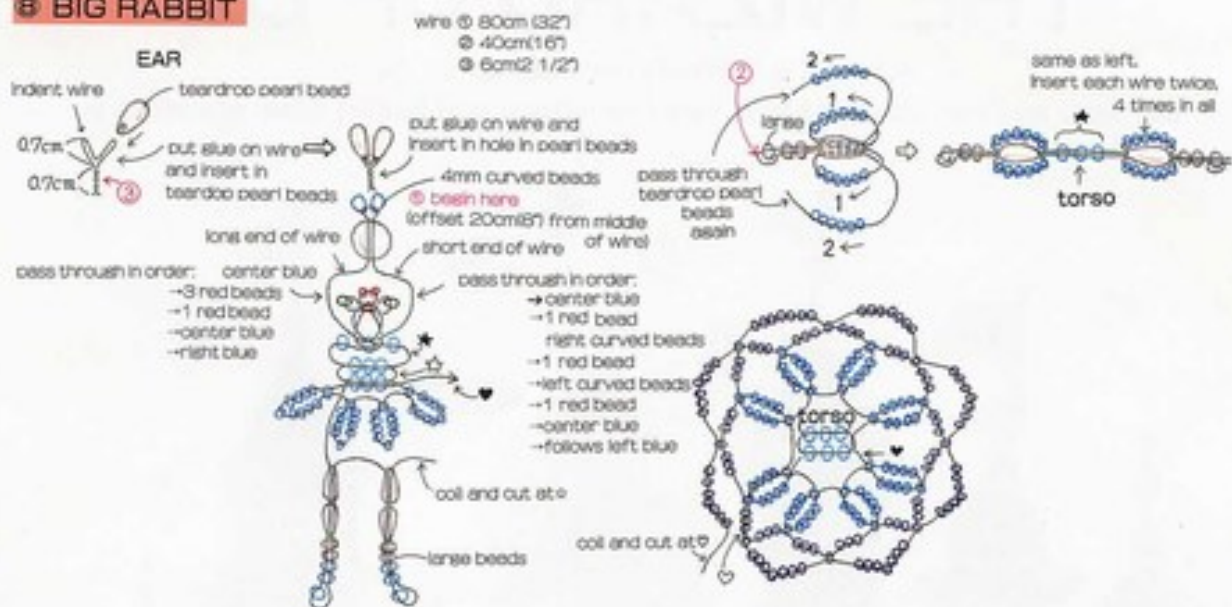

## 10 TULIP

wire ① 60cm(24) ② 100cm(40)

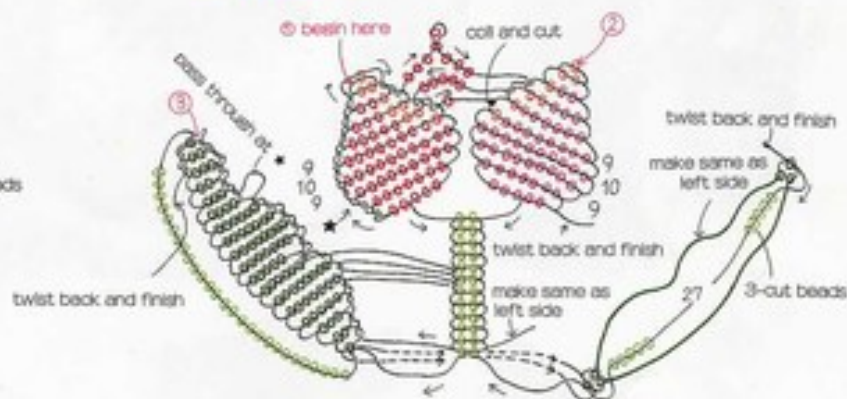

## 9 LITTLE RABBIT

wire ① 70cm(28) ② 6cm(2 1/2)

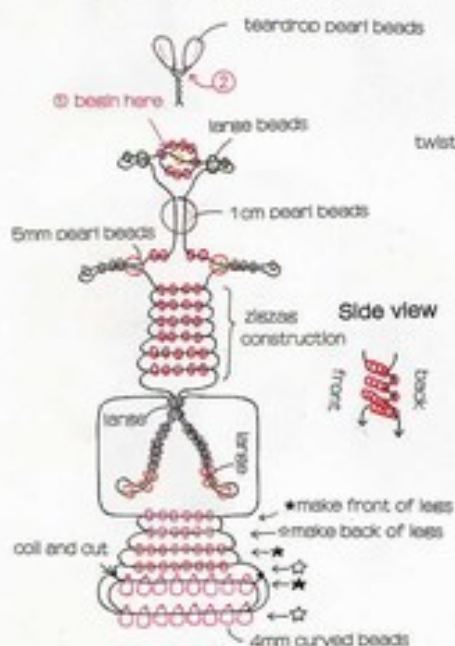

## 11 ANTHURUM

wire 70cm(28)

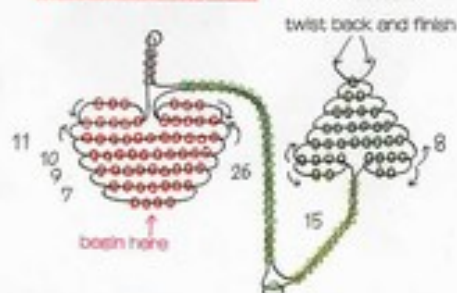

# LE MAGICIEN D'OZ

Après que la tornade l'ait emmenée au Pays d'Oz,  
Dorothée et ses trois amis rencontrent le Magicien et débutent leurs aventures.



**EXPLICATIONS  
ET MATÉRIEL**

petites et grosses perles de rocaïlle, perles carrées de 3 mm, perles goutte de 3 et 4 mm, perles tube de 3 mm, perles nacrées de 3, 4, 5 et 8 mm, perles nacrées en goutte de 4 x 8 mm et 5 x 7 mm, fil de fer de 0,4 mm. **Prenez des grosses perles de rocaïlle sauf indication contraire.**

**1. DOROTHÉE**

fil de fer :  
① 110 cm  
② 45 cm

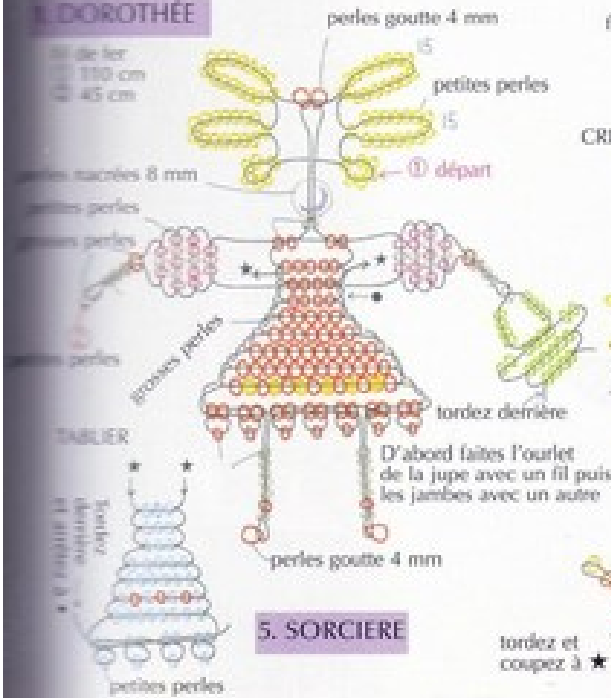

fil de fer : ① 80 cm  
② 40 cm  
③ 30 cm

**2. LION**

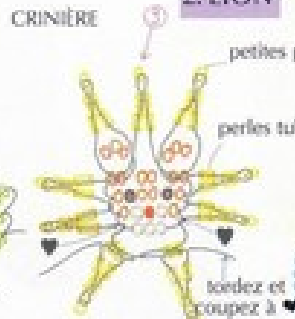

**3. REINE**

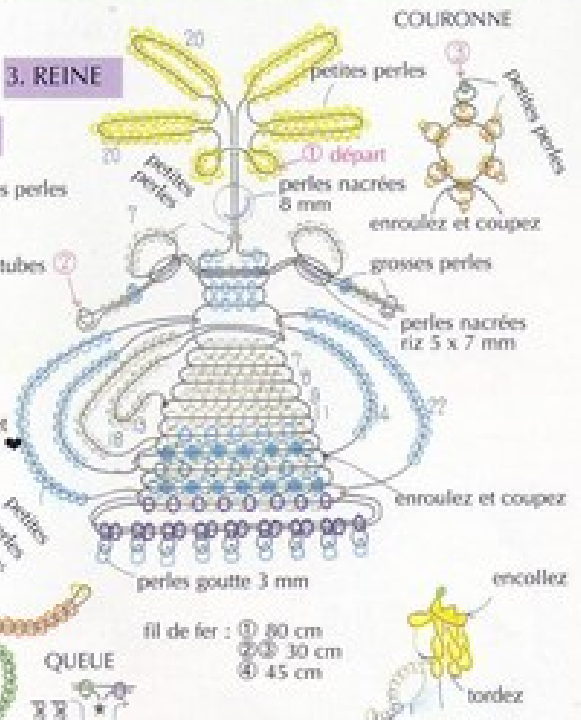

**5. SORCIÈRE**

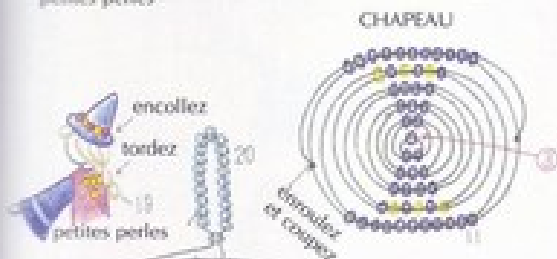

**6. ÉPOUVANTAIL**

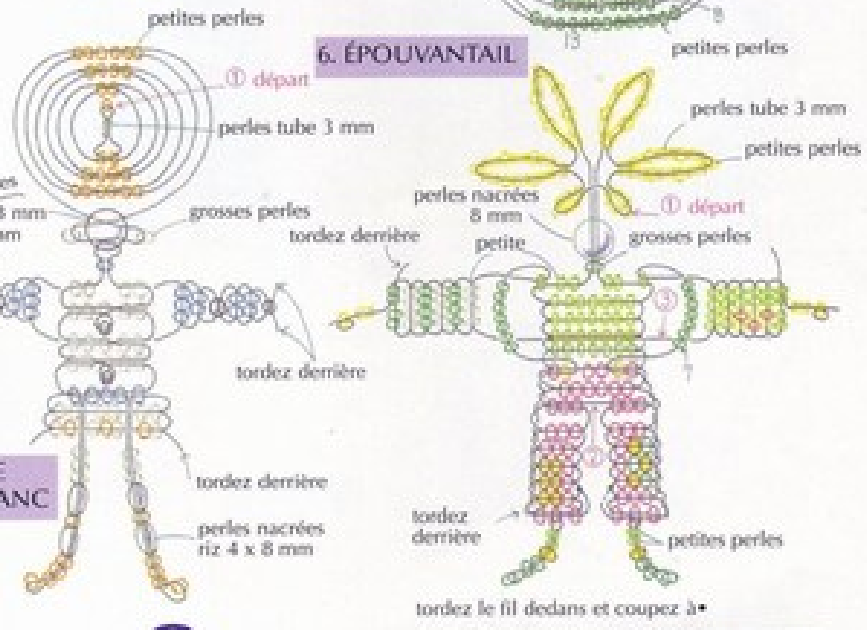

**4. HOMME EN FER-BLANC**

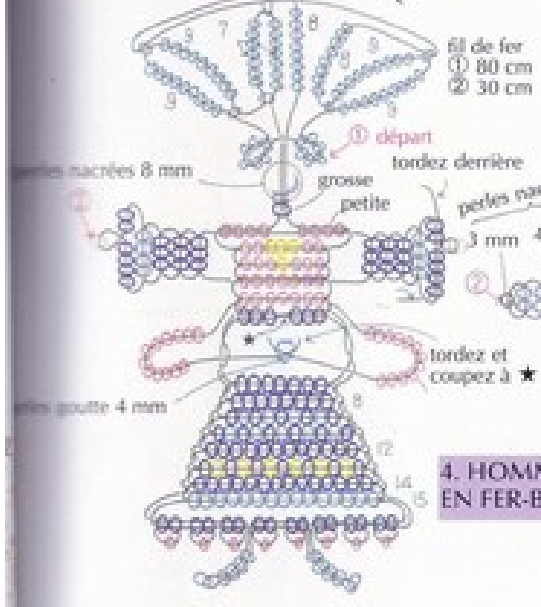

# ANNE'S ROOM

Let's make a house and all the furniture like chairs, table, bed and rocking chair!







# FOREST SYMPHONY

It's the Forest Symphony! Everyone's singing and dancing to the music of the animals.



INSTRUCTIONS FOR MUSICAL NOTES ON PAGE 53

8





**INSTRUCTIONS AND MATERIALS**

small & large round beads, 3 & 4mm curved beads, bugle beads, R4 & R10 wood beads, 5, 10, 12 & 15mm pearl beads, #34 wire, glue.

Use large round beads unless otherwise indicated

**1 CLOWN**

when making the tights, begin 10cm(4") from the middle of the wire

wire @ 90cm(36") if making tights, otherwise 80cm(32")  
 @ 30cm(12")  
 @ 45cm(18")

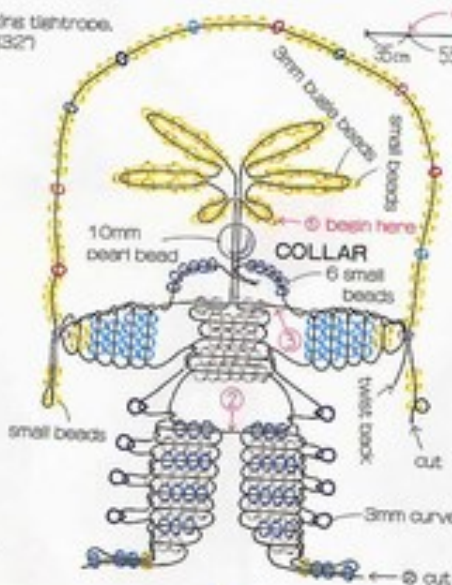

**2 BEAR**

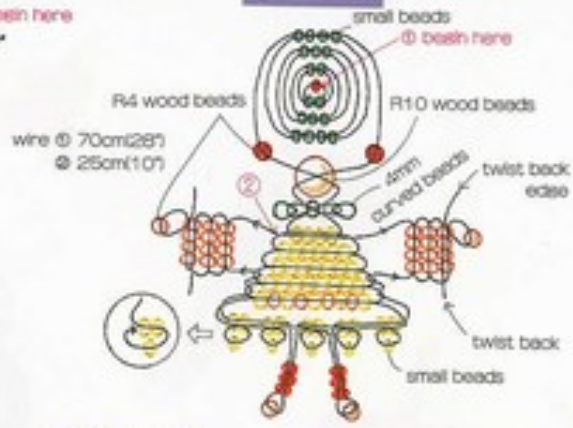

**4 BALL**

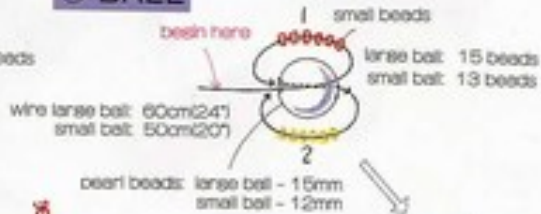

**3 BICYCLE**

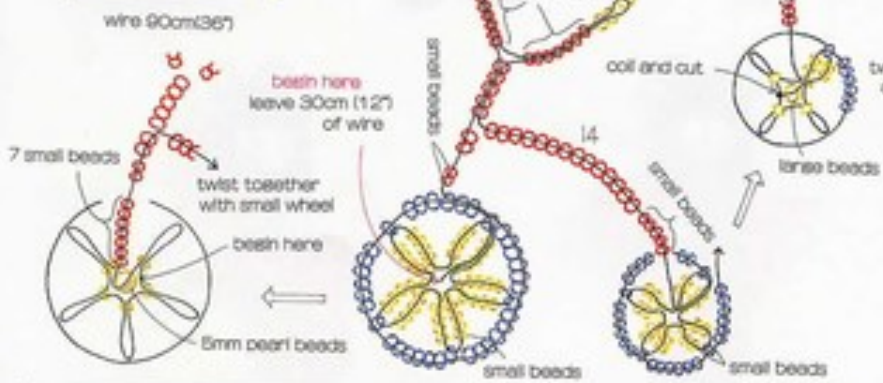

**COIN PURSE AND RING (CONTINUED FROM PAGE 37)**

**5 RHINESTONE RING**

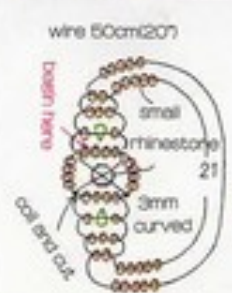

**7 PEARL RING**



**9 PEARL RING**

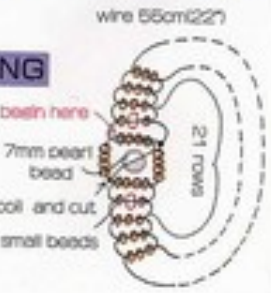

**6 FLOWER RING**

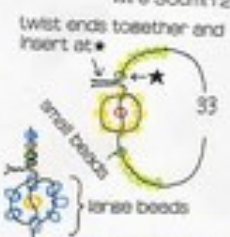

**8 FLOWER RING**



# NEW YEAR'S

Children in traditional costume enjoy festive Japanese New Year's games.



GIRL'S BACK VIEW



**INSTRUCTIONS AND MATERIALS**

small & large round beads, 3 & 4mm curved beads, 3-cut beads 5 & 10mm pearl beads, #34 wire, plus.

Use large round beads unless otherwise indicated

**1 GIRL** wire ① 80cm(32") ② 40cm(16") ③ 25cm(10")

pass through in order: curved bead-small blue bead  
-curved bead-small brown bead-curved bead-pearl bead

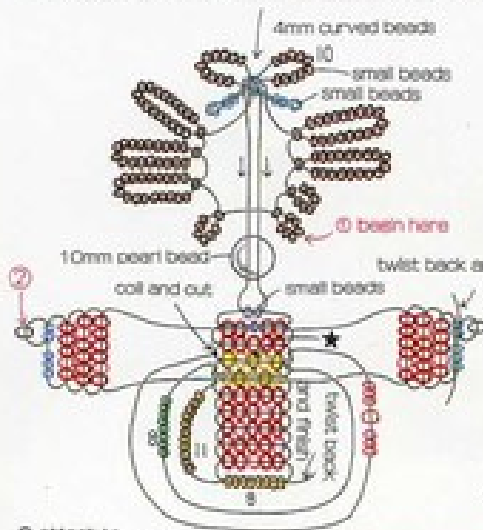

③ attach to girl's back



**2 BOY**

wire ① 80cm(32") ② 40cm(16")

pass through in order: large bead-small violet bead  
-large bead-small brown bead-large bead-pearl bead

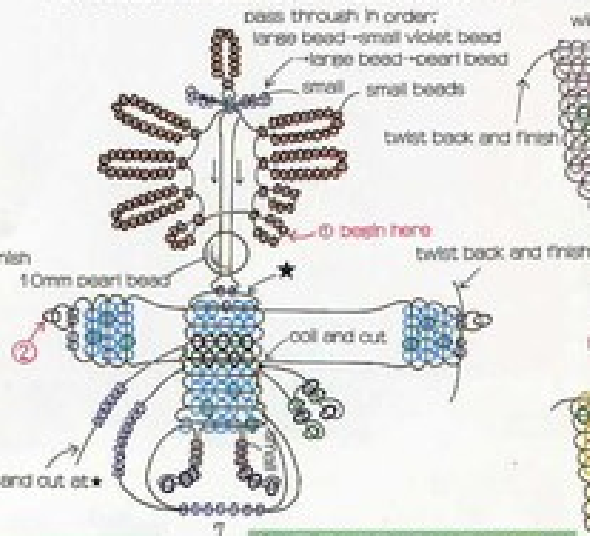

**3 4 HAGOITA RACKET**



**5 GIRL'S SLIPPERS**

wire 55cm(22")

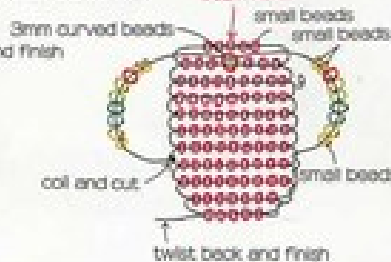

**6 BOY'S SLIPPERS**

wire 55cm(22")

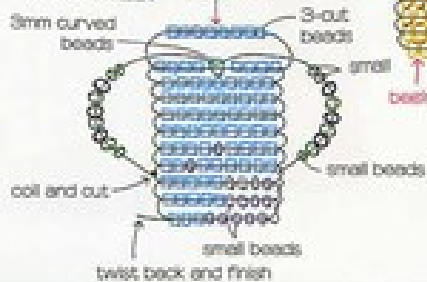

**7 SHUTTLECOCK**

wire 30cm(12")

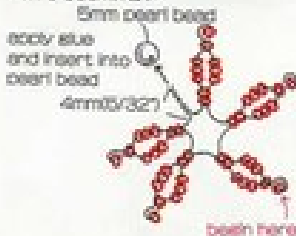

**8 TOP**

wire 50cm(20")

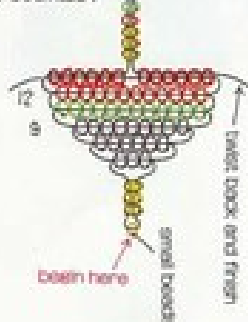

**FLOWER ACCESSORIES FROM PAGE 41**

**9 BARRETTE**

130 wire  
① 70cm(28")  
② 60cm(24") 2 pieces

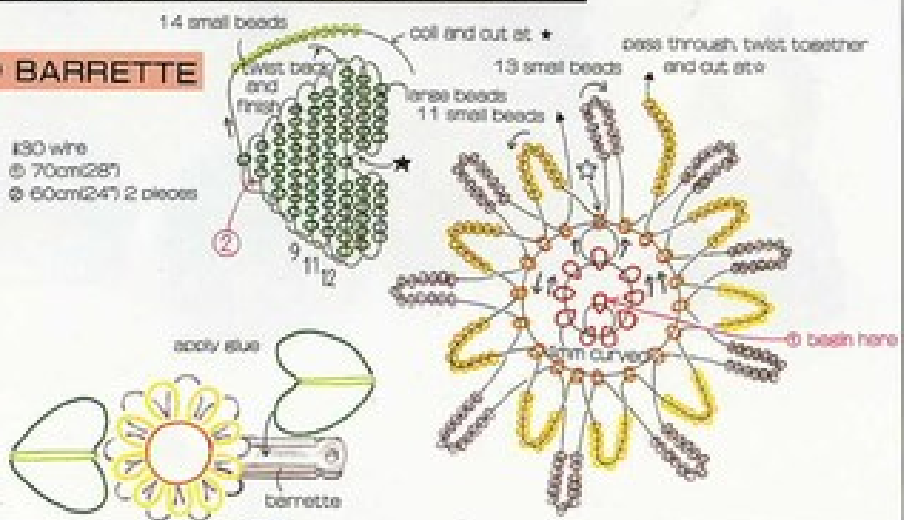

# THE DOLL FESTIVAL

The base of dried clay covered with beads makes this doll set very stable.





# INSTRUCTIONS AND MATERIALS

small & large round beads, 4mm curved beads, small hexagonal beads, bugle beads, small beads, 6, 10 & 14mm pearl beads, 6x8mm oval pearl beads, #28 & #34 wire, #20 craft thread, clay, glue.

Use small round beads unless otherwise indicated

## 1 EMPEROR

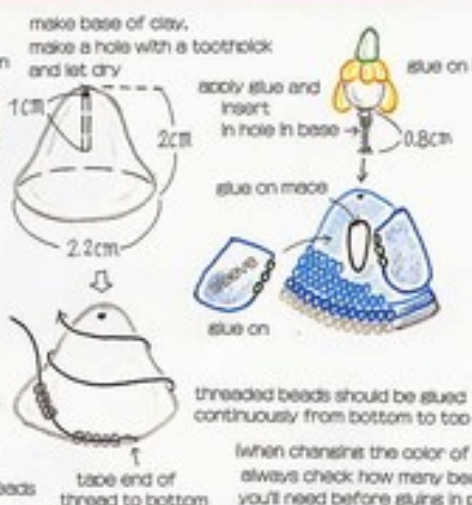
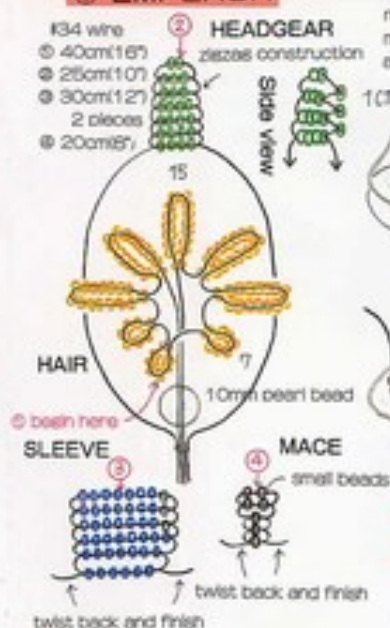

## 2 EMPRESS

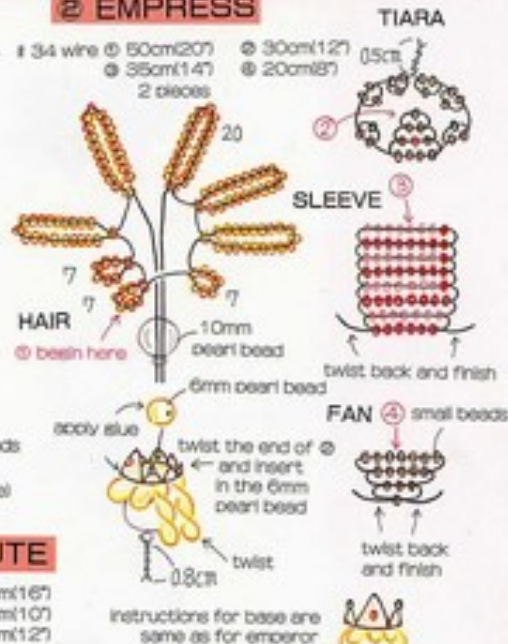

## 3 THREE COURT LADIES SMALL WOOD STAND

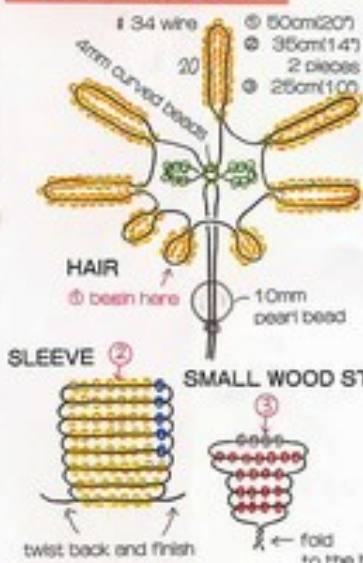

## 4 FIVE MUSICIANS LARGE HAND DRUM

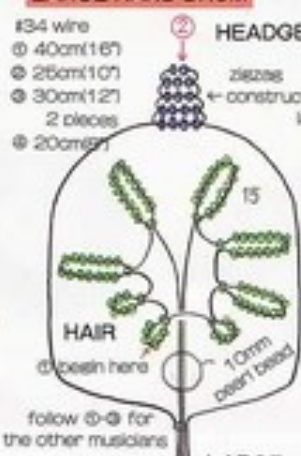

## 5 FLUTE



## 7 RECORDER



## 6 DRUM



## 8 SMALL DRUM



# CHRISTMAS

Simple little bead crafts, such as frames and cards, that make great gifts!



ACTUAL-SIZE PICTURES Make a diagram following this photo and embroider

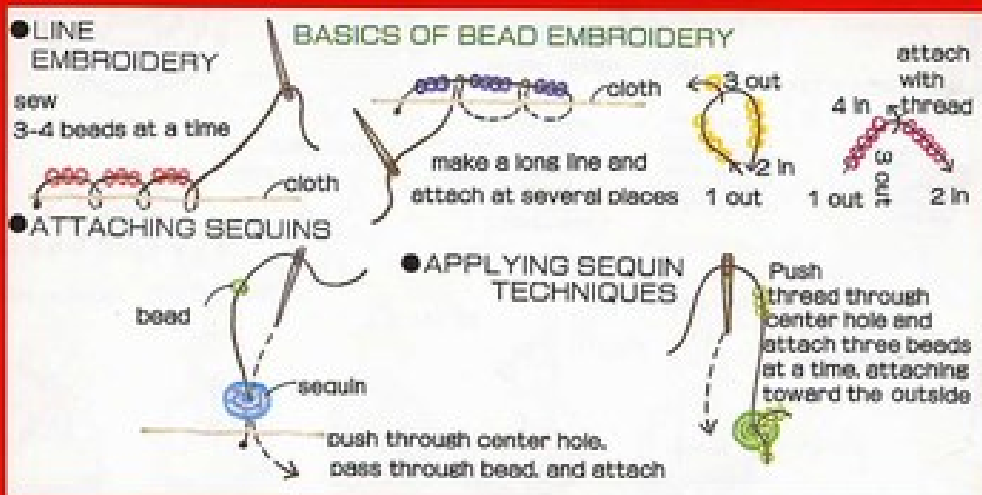



# GARDEN PARTY

A tea party with ladies in long dresses.

Dolls with clay bases can be moved anywhere you like.



INSTRUCTIONS ON PAGE 20



# INSTRUCTIONS AND MATERIALS

small & large round beads, 3mm curved beads, 1.5mm bugle beads, small beads, 2.5, 4 & 8mm pearl beads, 3x6, 4x8 & 5x7mm oval pearl beads, 4mm colored pearl beads, #28 & 34 wire, #20 craft thread, clay, glue.

Use small round beads unless otherwise indicated

## 1 BLUE-GREEN DRESS

### HAIR



#34 wire  
 ① ② 40cm(1'6")  
 ③ 50cm(2'4")  
 ④ 20cm(8") 2 pieces

### FLOWER

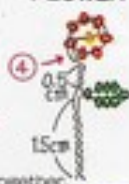

① basin here

8mm pearl bead

5x7mm oval pearl bead

twist 4 wires together, pass through body and stick into base

②

laced beads

zissas construction

③

make base of clay, make hole with toothpick, and let dry

④

LACE

repeat \* 18 times

⑤

hole

1cm

5cm

twist ends of lace together and glue to base

3.6cm

⑥

apply glue to clay and wind threaded beads from bottom to top. It is easy to change color of dress if beads are counted and threaded first, then glued to base!

⑦

twist

twist and insert in hand

1cm

pass wires ① & ② through torso and twist, apply glue, and insert into base

⑧

small beads

twist

⑨

⑩

⑪

⑫

⑬

⑭

⑮

⑯

⑰

⑱

⑲

⑳

㉑

㉒

㉓

㉔

㉕

㉖

㉗

㉘

㉙

㉚

㉛

㉜

㉝

㉞

㉟

㊱

㊲

㊳

㊴

㊵

㊶

㊷

㊸

㊹

㊺

㊻

㊼

㊽

㊾

㊿

### BAG

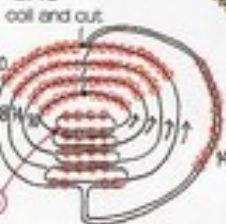

coil and cut

20

8mm pearl bead

①

②

③

④

⑤

⑥

⑦

⑧

⑨

⑩

⑪

⑫

⑬

⑭

⑮

⑯

⑰

⑱

⑲

⑳

㉑

㉒

㉓

㉔

㉕

㉖

㉗

㉘

㉙

㉚

㉛

㉜

㉝

㉞

㉟

㊱

㊲

㊳

㊴

㊵

㊶

㊷

㊸

㊹

㊺

㊻

㊼

㊽

㊾

㊿

## 2 WHITE DRESS

#34 wire  
 ① ② 40cm(1'6")  
 ③ 50cm(2'4")  
 ④ 25cm(1'0")  
 ⑤ 10cm(4")  
 ⑥ 50cm(2'0")

### HAIR

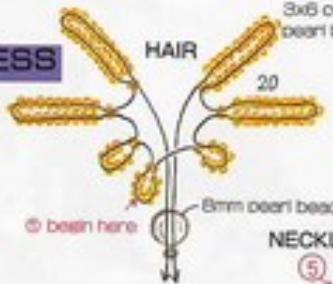

① basin here

### NECKLACE



### LACE



repeat \* 20 times

### HAIRPIN



3mm curved beads

3mm curved beads

3mm

0.5cm

apply glue and insert in pearl bead

## 3 GREEN DRESS

#34 wire  
 ① ② 40cm(1'6")  
 ③ 50cm(2'0")  
 ④ 45cm(1'8")  
 ⑤ 15cm(6")

### HAIR



8mm pearl bead

① basin here

②

③

④

⑤

⑥

⑦

⑧

⑨

⑩

⑪

⑫

⑬

⑭

⑮

⑯

⑰

⑱

⑲

⑳

㉑

㉒

㉓

㉔

㉕

㉖

㉗

㉘

㉙

㉚

㉛

㉜

㉝

㉞

㉟

㊱

㊲

㊳

㊴

㊵

## 4 RED DRESS

#34 wire  
 ① ② 40cm(1'6")  
 ③ 50cm(2'0")  
 ④ 15cm(6")

### HAIRPIN



back

front

### HAIR

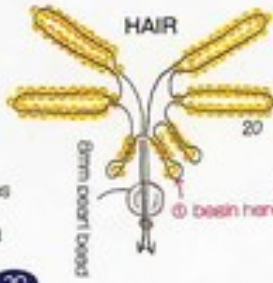

8mm pearl bead

① basin here

②

③

④

⑤

⑥

⑦

⑧

⑨

⑩

⑪

⑫

⑬

⑭

⑮

⑯

⑰

⑱

⑲

⑳

㉑

㉒

㉓

㉔

㉕

㉖

㉗

㉘

㉙

㉚

㉛

㉜

㉝

㉞

㉟

㊱

㊲

㊳

㊴

㊵

㊶

㊷

㊸

㊹

㊺

㊻

㊼

㊽

㊾

㊿

### LACE



repeat \* 28-33 times

number of beads needed depends on their shade

①

②

③

④

⑤

⑥

⑦

⑧

⑨

⑩

⑪

⑫

⑬

⑭

⑮

⑯

⑰

⑱

⑲

⑳

㉑

㉒

㉓

㉔

㉕

㉖

㉗

㉘

㉙

㉚

㉛

㉜

㉝

㉞

## 5 YELLOW DRESS

#34 wire  
 ○ 40cm(16")  
 ○ 60cm(24")  
 ○ 15cm(6")

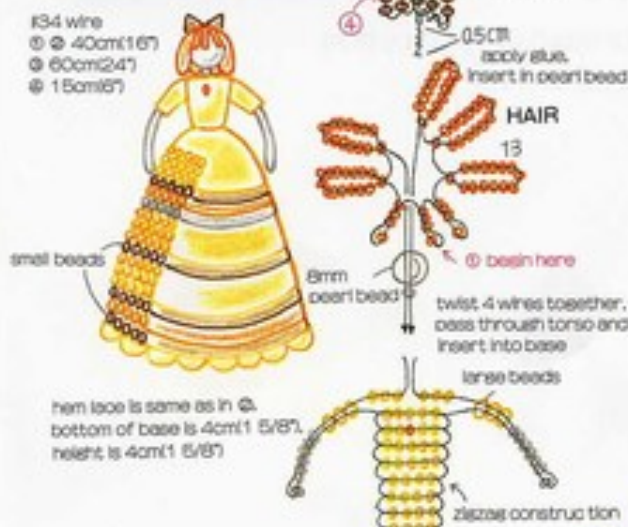

## 6 BLUE DRESS

#34 wire  
 ○ 40cm(16")  
 ○ 50cm(20")  
 ○ 60cm(24")



## 7 PINK DRESS

#34 wire  
 ○ 40cm(16")  
 ○ 60cm(24")  
 ○ 45cm(18")



## 8 CACTUS

#34 wire 30 cm(12") 2 pieces  
 make 1cm(3/8") hole with toothpick

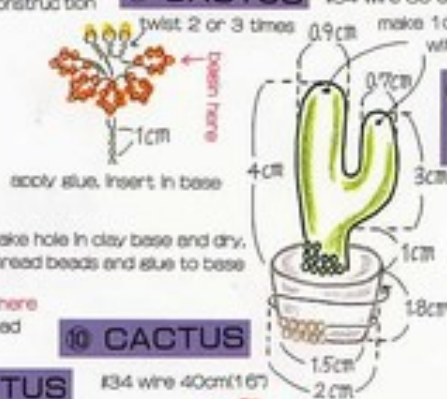

## 11 HANGING PLANT



## 9 CACTUS

#34 wire 40cm(16")

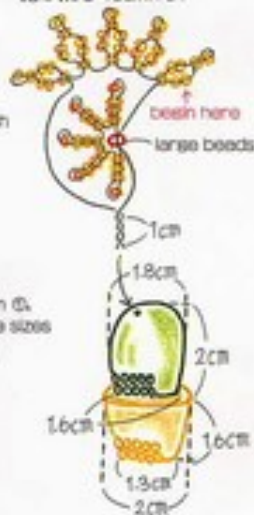

CONTINUED ON PAGE 57.  
 ① CONTINUED ON PAGE 9

# ANIMAL UNITED NATIONS

Chaired by the Owl, the penguin represents Antarctica  
and the giraffe represents Africa





**INSTRUCTIONS AND MATERIALS**

small & large round beads, 3 & 4mm curved beads, 3-cut beads, 3mm bugle beads, small beads, #31 & #34 wire.

Use small round beads unless otherwise indicated

**2 GIRAFFE**



**3 PEACOCK**

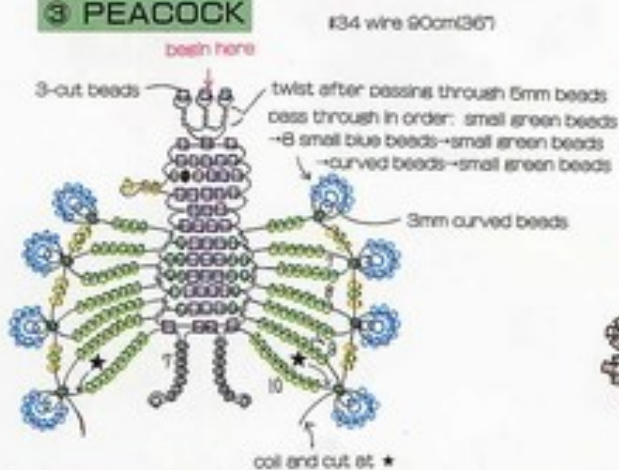

**7 ELEPHANT**

adult #31 wire ① 80cm(32") ② 45cm(18")  
calf #34 wire ① 70cm(28") ② 40cm(16")

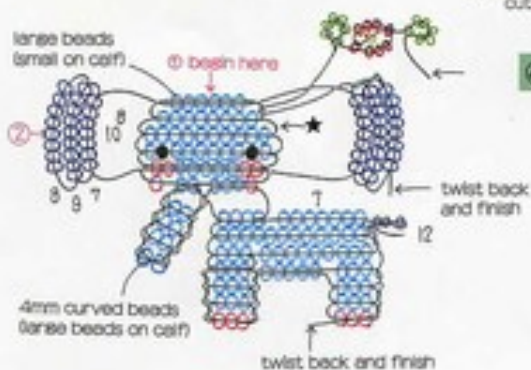

**CALF'S HORNS**



**1 MONKEY**

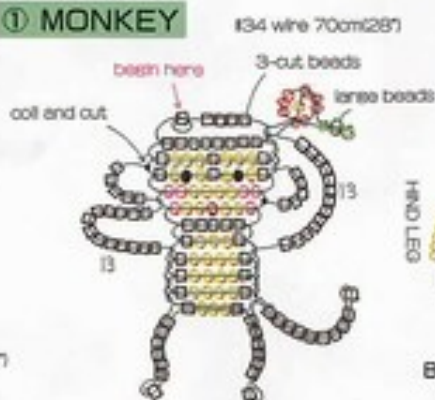

**6 LION**

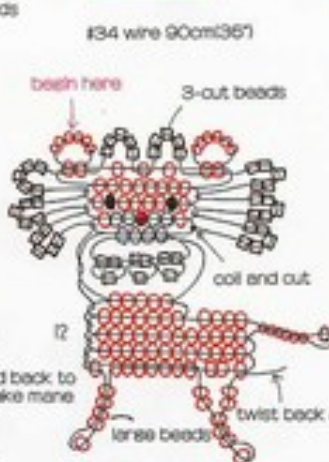

**4 PENGUIN**

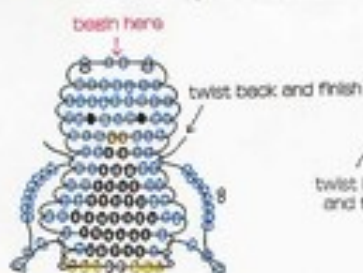

**5 KANGAROO**

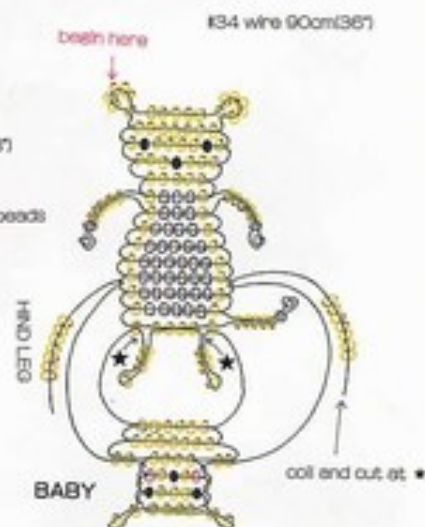

**6 OWL**

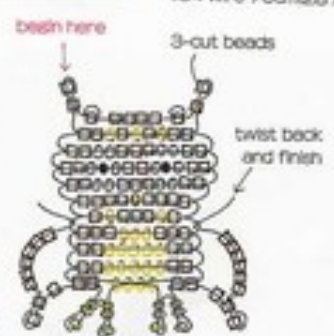

**8 LEOPARD**

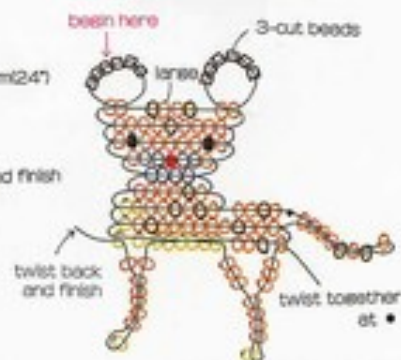

# RABBIT FAMILY

The rabbit family always has a good time. Today they're having the bear girls over.

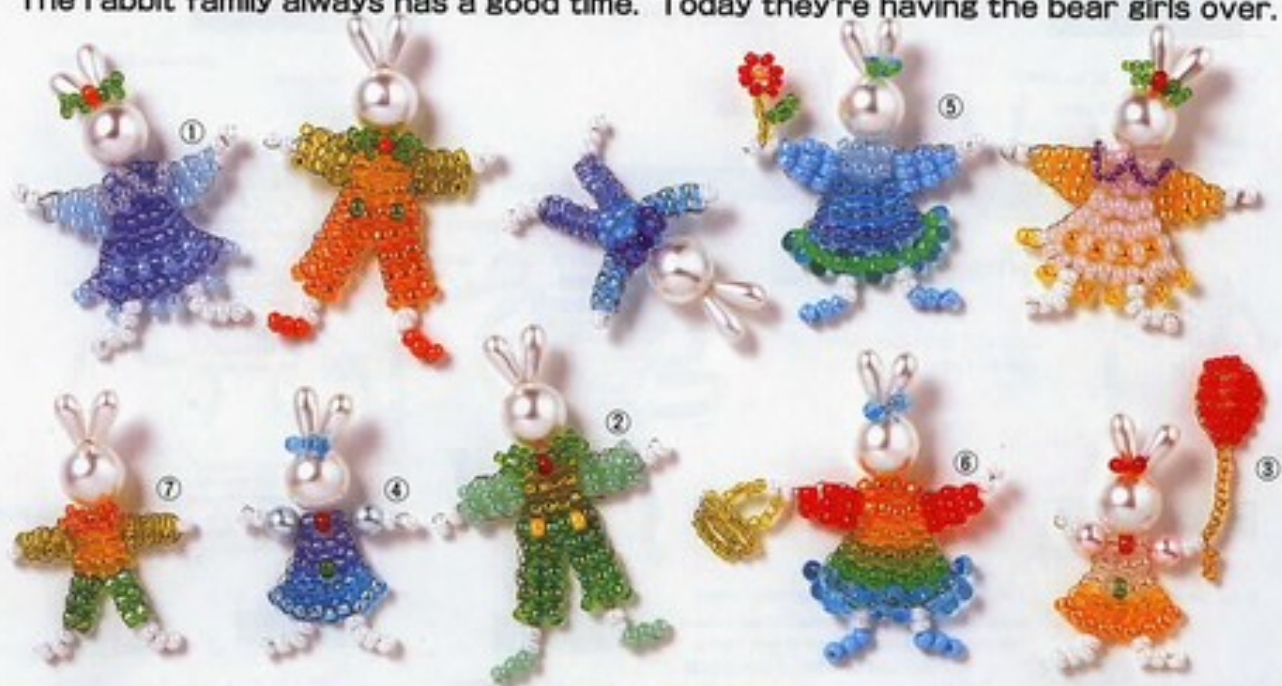

INSTRUCTIONS FOR BEAR ON PAGE 27  
INSTRUCTIONS FOR POTTED PLANT ON PAGE 58



# BEAR FAMILY

The fashionable bears love having guests.

Today they've invited the rabbit family from Fairyland.



INSTRUCTIONS FOR RABBITS ON PAGE 3  
INSTRUCTIONS FOR PLANTS ON PAGE 57

**INSTRUCTIONS  
AND  
MATERIALS**

small & large round beads, 3 & 4mm curved beads, 5mm pearl beads,  
R4, R10, C45 & C47 wood beads, #28 & 34 wire, glue.

Use large round beads and #34 wire unless otherwise indicated

**2 FLOWER GIRL**



**1 GIRL WITH BASKET**

wire 60cm(24) 30cm(12)  
4mm curved beads

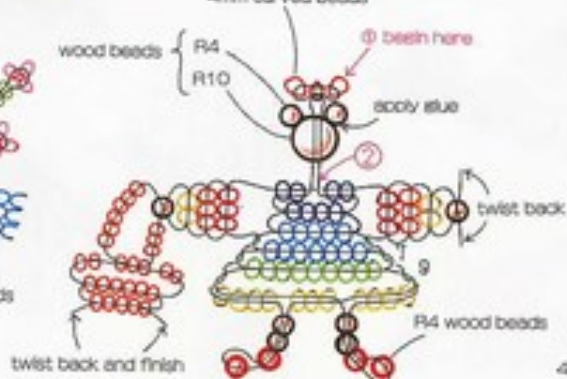

**4 BOY WITH PRESENT**

wire 70cm(28) 30cm(12)

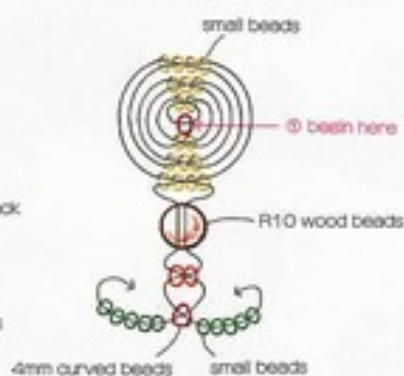

**3 LITTLE GIRL**

wire 45cm(18)

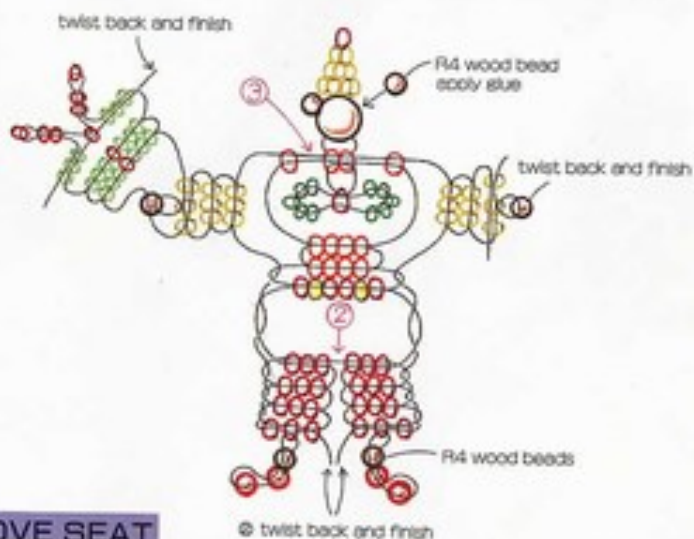
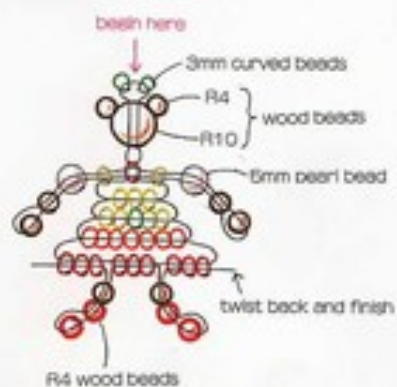

**5 TABLE**

#28 wire 100cm(40)  
all wood beads

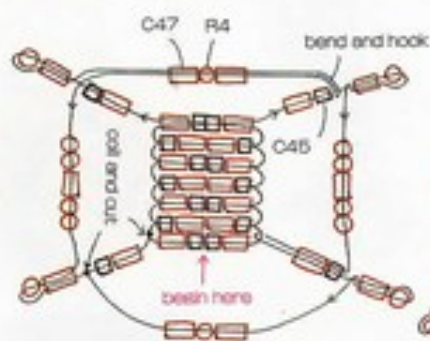

**6 LOVE SEAT**

#28 wire 100cm(40)  
all wood beads

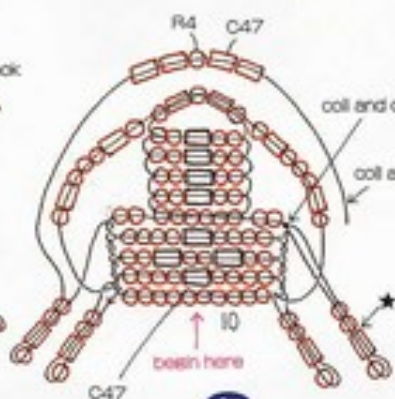

**7 CHAIR**

#28 wire 90cm(36)  
all wood beads

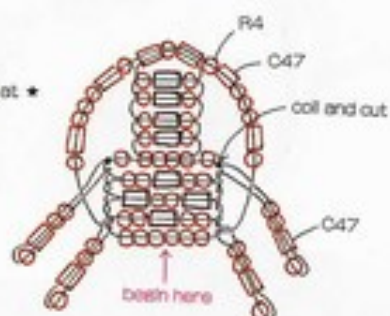

# OCEAN PARADISE

The home of the mermaid is vibrant with color.  
Strange fish, dolphins, and whales enjoy themselves in the coral.







## NAME PLATE

Arrange these beautiful letters any way you like.  
Attach them to clothes, bags, or magnets.



# MUSICAL PARADE

Sew on to your purse or use as a brooch.



# DRESS UP YOUR KITCHEN

Attach these beautiful crafts to magnets to make useful decorations.



**INSTRUCTIONS  
AND  
MATERIALS**

small & large round beads, 3-cut beads, small hexagonal beads, 3 & 4mm curved beads, small beads, 4, 8, 10, 12 & 15mm pearl beads, 3x6mm oval pearl beads, 3, 4, 6 & 7mm, & 3x6mm colored pearl beads, 6mm rainbow pearl beads, #20 & #34 wire, #20 bead thread, 3cm (1 1/4") round, heart- & star-shaped magnets, glue.  
Use small round beads unless otherwise indicated

**1 RADISH**

wire 40cm(16")  
coil and out



**2 CARROT**

wire 40cm(16")



**7 GRAPES**

wire 45cm(18")

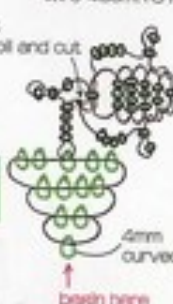

**3 CUCUMBER**

wire 40cm(16")



**4 CORN**

wire 45cm(18")



**5 EGGPLANT**

wire 35cm(14")



**6 ONION**

wire 40cm(16")



**8 CANDY**

wire 80cm(32")

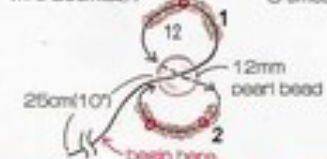

**9 CANDY**

wire 80cm(32")

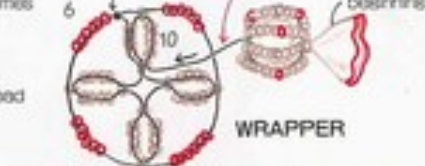

**11 CHAMPAGNE GLASS**

wire 85cm(34")  
#20 wire 2cm(3/4")

bead here  
leave 35cm(14")

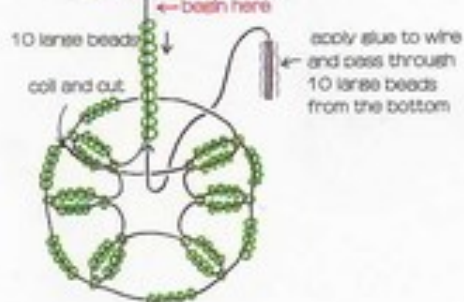
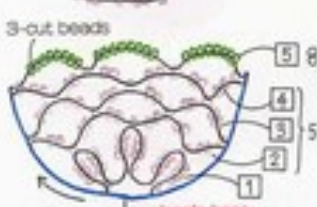
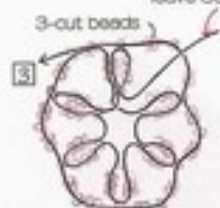

**12 CANDY**

wire 80cm(32")

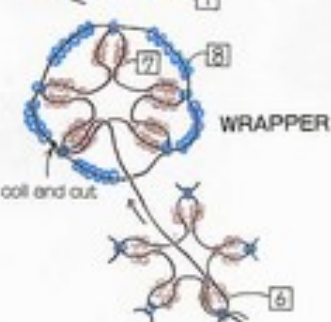
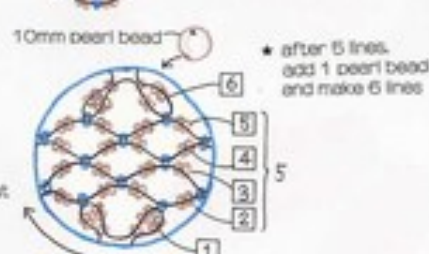
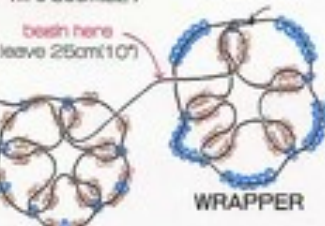

**10 CANDY**

wire 80cm(32")

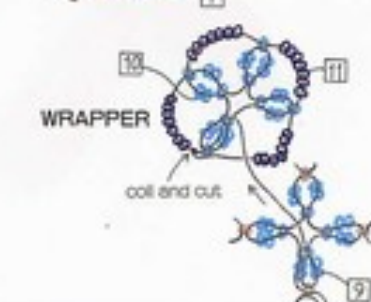
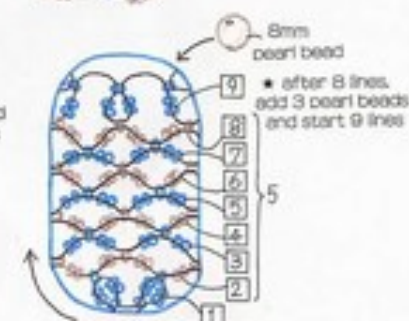
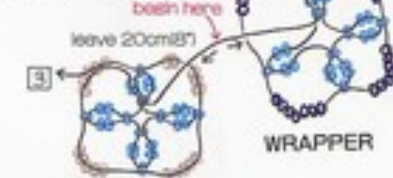

# SUMMER AT THE BEACH

The 3-D hat, parasol, basket, bag, and sandals are pretty accessories for your brooch or key chain.



**INSTRUCTIONS  
AND  
MATERIALS**

small & large round beads, 3-cut beads, 3 & 4mm curved beads, #31 & #34 wire.

Use small round beads unless otherwise indicated

**1 SANDALS**

#34 wire 100cm(40")  
15cm(6")

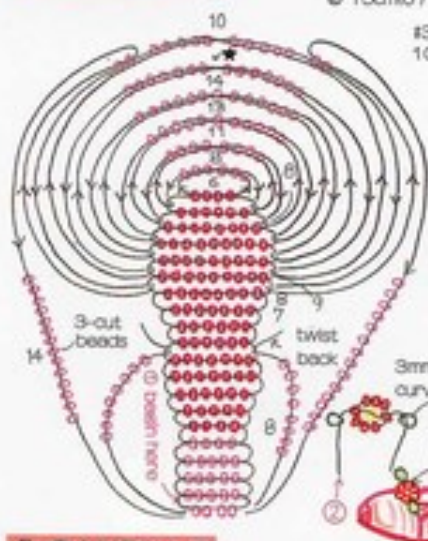

**2 BEACH SHOES**

#34 wire  
100cm(40")

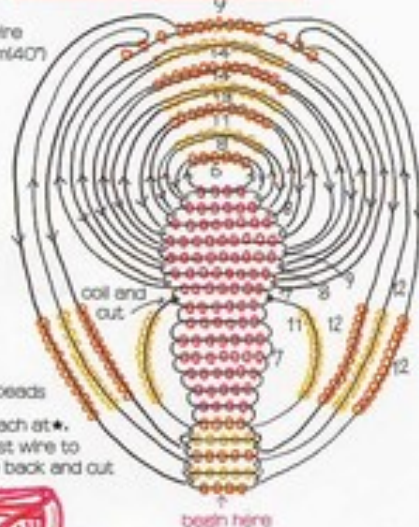

**3 SANDALS**

#34 wire  
95cm(38")

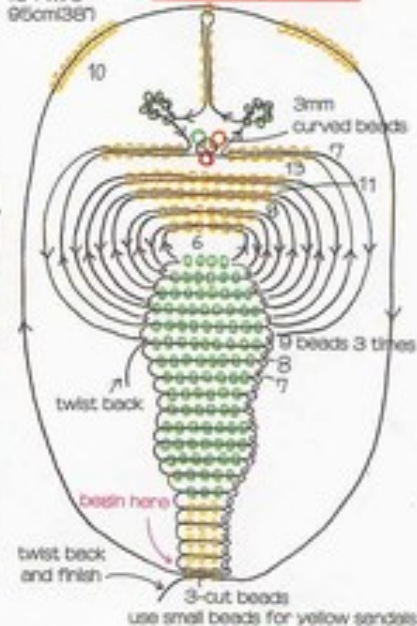

**4 SANDALS**

#34 wire 90cm(36")



**6 BASKET**

#34 wire 90cm(36")  
30cm(12")  
20cm(8")  
leave 7cm(2 3/4")

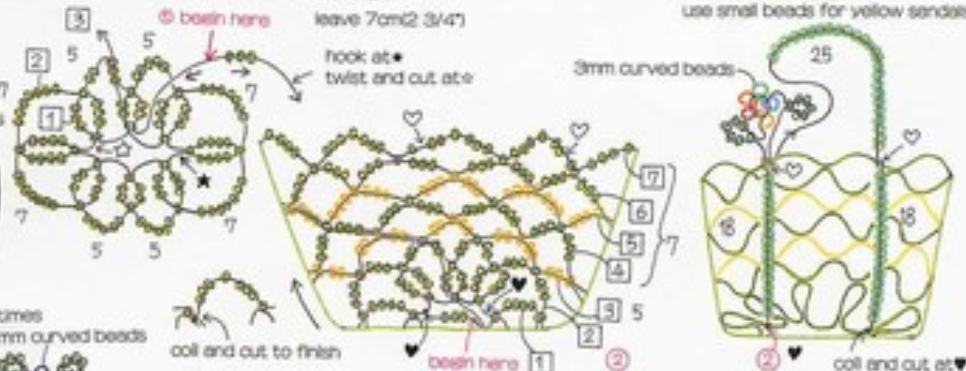

**5 SANDALS**

#34 wire 95cm(38")

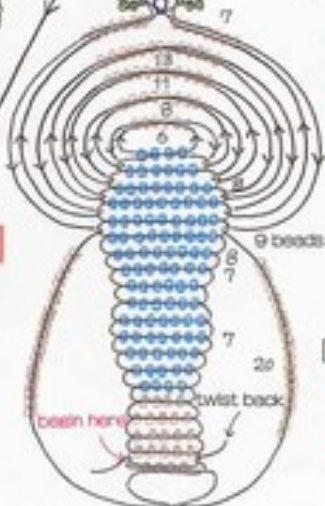

**7 PARASOL**

#34 wire 100cm(40")  
#28 wire 20cm(8")

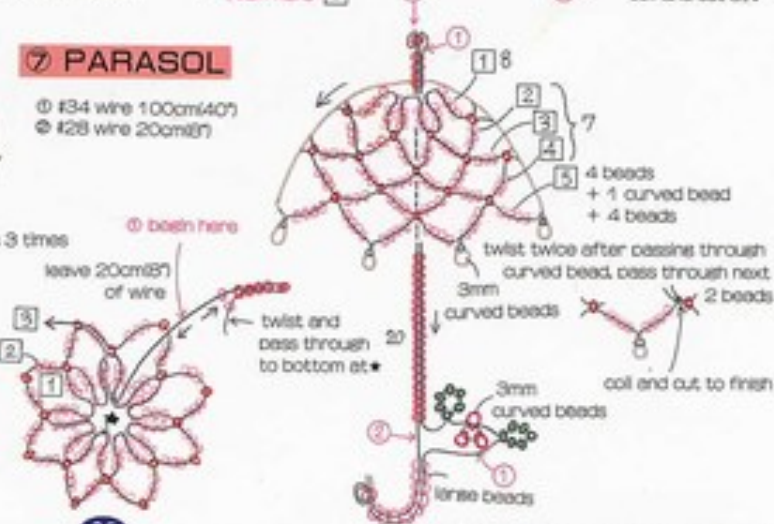

# COIN PURSE AND RINGS

Crochet after passing lace thread through beads



INSTRUCTIONS FOR SHOES ON PAGE 35  
INSTRUCTIONS FOR HAT ON PAGE 60

**INSTRUCTIONS AND MATERIALS**

small & large round beads, small beads, 3 & 4mm curved beads, small beads, 3, 4, 6 & 10mm pearl beads, 6mm shell beads, 8mm baroque pearl beads, 4.8mm rhinestone, part U-402 leaf bead, hot pin, key holder, 4.5cm (1 3/4") diameter clasp, #3-4 wire, #40 lace thread, #8 lace needle, blue.

Use large round beads unless otherwise indicated

**1 COIN PURSE**

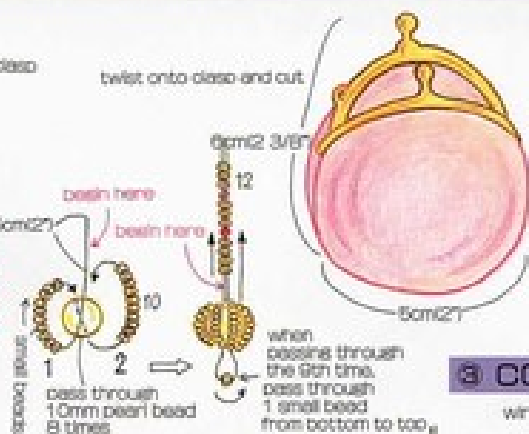
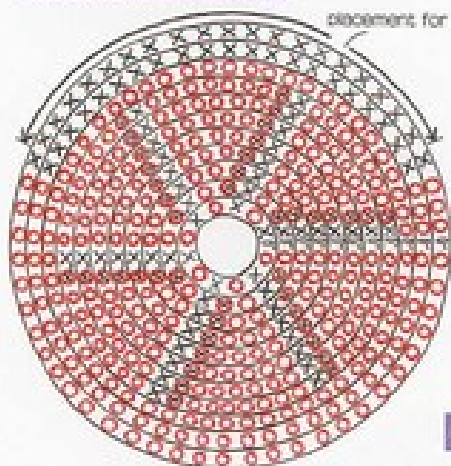

- 1 pass lace thread through 300 large beads
- 2 make two as in chart
- 3 cut together right side out, leave clasp placement, and finish with esther stitch
- 4 leave 40cm (16") thread, cut, and attach clasp

**4 COIN PURSE**

Pass lace thread through clear beads and stitch. This will make them appear colored

**3 COIN PURSE**

wire 40cm (16")

**2 COIN PURSE**

wire 25cm (10")

- chain stitch
- tacking stitch

- esther stitch
- esther stitch with beads
- make two esther stitches



**MAKE GATHER STITCH WITH BEADS**

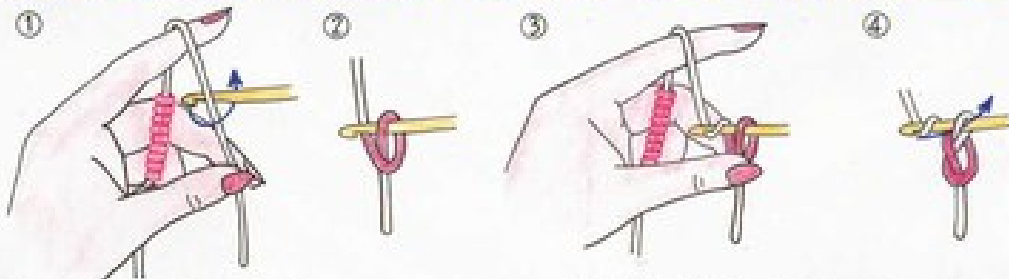

pass through proper number of beads

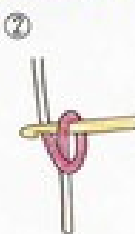

make one chain stitch without beads (starting)

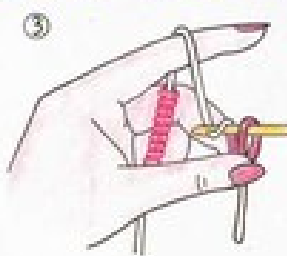

bead stitching into the hole (do not cut beads in the first one)



cut one bead in front and stitch as shown in 5 & 6

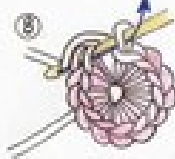

stitch necessary number of times and tack once



rear view

# PEARL ACCESSORIES

The bouquet ribbon works well as a barrette or brooch, the necklace goes well with a flowered blouse







# FLOWER ACCESSORIES

The bracelet is easy to make and is a great present.



# INSTRUCTIONS AND MATERIALS

small & large round beads, small beads, 3 & 4mm curved beads, small beads, 3, 4, 5, 6, 8, 10, & 12mm pearl beads, 8mm shell beads, 4x8mm teardrop pearl beads, crystal-cut beads, 5mm colored pearl beads, 6mm pearl beads, rhinestone, hemisphere glass stones, leaf beads, flower-cut bead, brooch pin, hat pin, rings, earring backings, large barrette, key ring, #28, #30 & 34 wire, craft filament, elastic, glue.

## 1 BRACELET

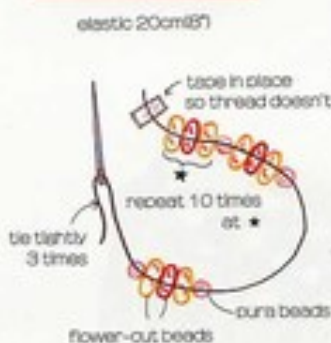

## 2 BARRETTE

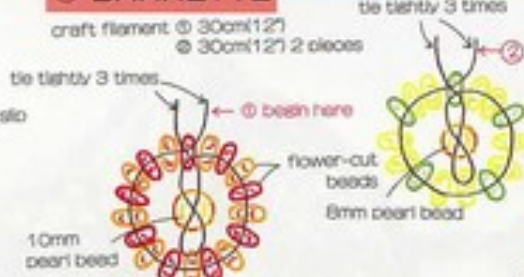

## 3 BARRETTE

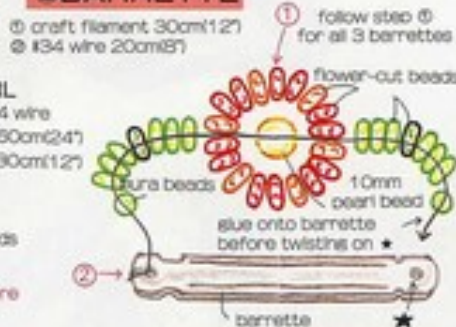

## 4 EARRINGS AND BROOCH

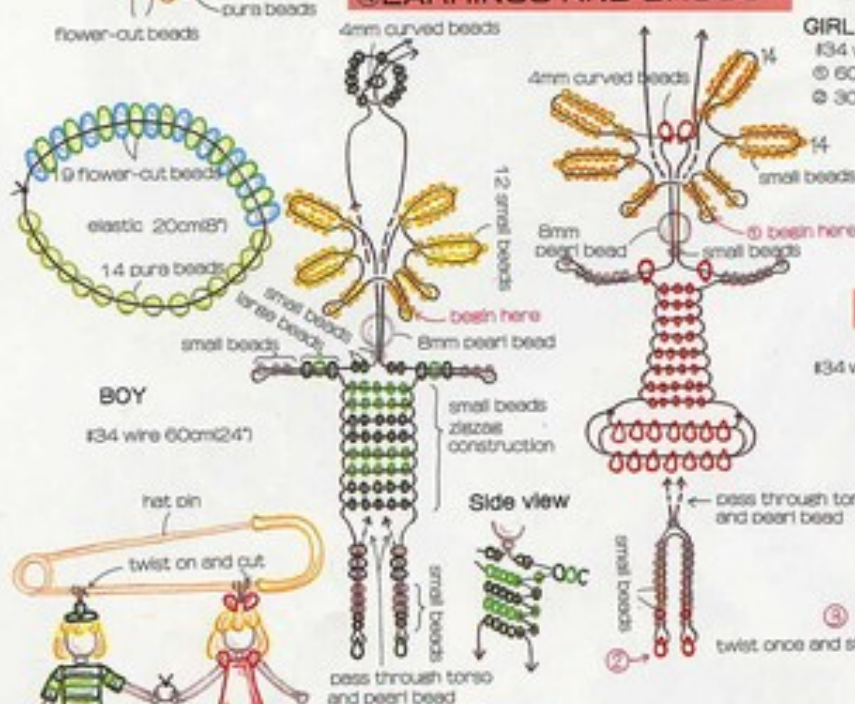

## 6 RABBIT BROOCH

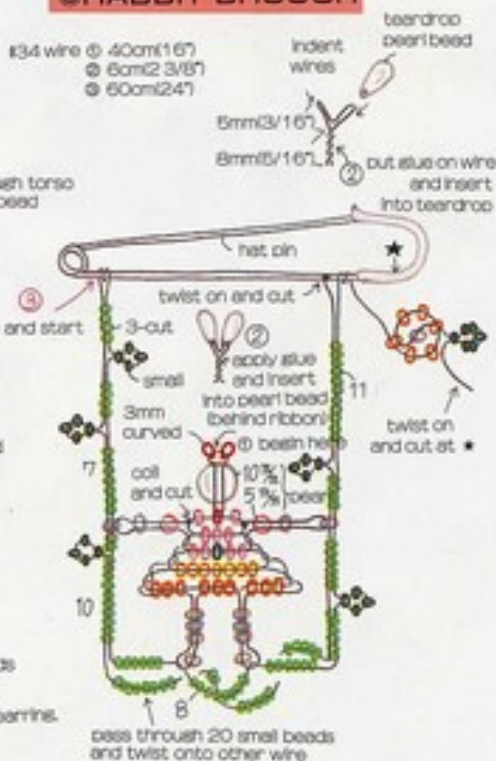

## 5 EARRINGS

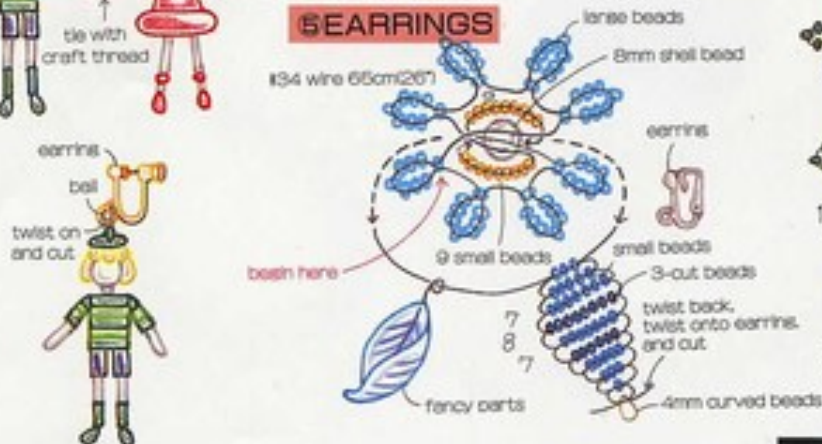

CONTINUED ON PAGE 13  
CONTINUED ON PAGE 43

# POUCH AND ACCESSORIES

The silver cat is made with easy embroidery.

Slightly large square beads in the necklace project a mature image.



**INSTRUCTIONS  
AND  
MATERIALS**

small & large round beads, small beads, small hexagonal beads, 3 & 4mm curved beads, small beads, 4, 8, 10, 12 & 15mm pearl beads, 4mm purakatto beads, 4.6mm rhinestone, 4.6mm hemisphere glass stone beads, 8mm mirror jewelry, spring rings, brooch pin, hat pin, rings, large barrette, #28 & #34 wire, craft filament, plastic board, glue.

Use large round beads unless otherwise indicated

**1 BROOCH**

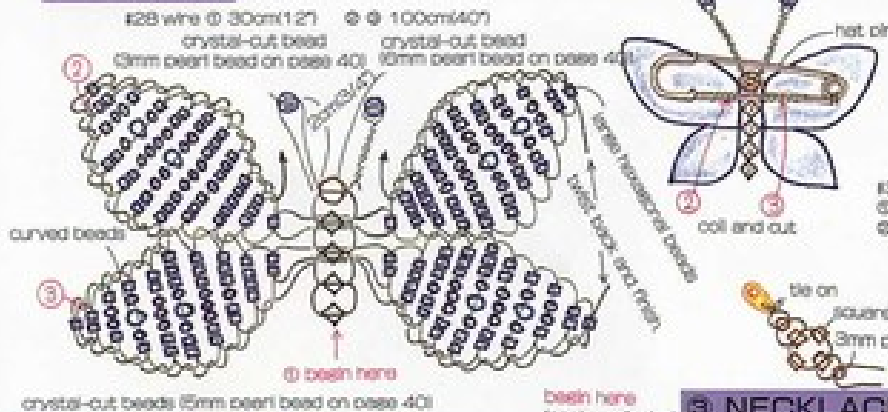

**2 BADGE / BROOCH**



**3 CLOWN BROOCH**

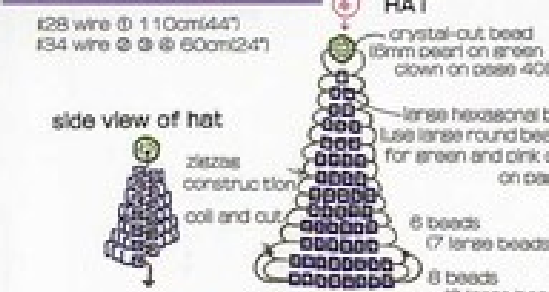

**3 NECKLACE**

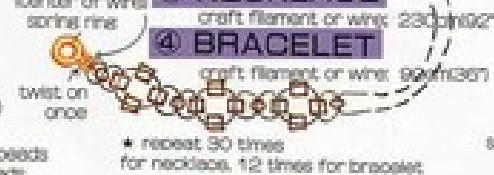

**4 BRACELET**

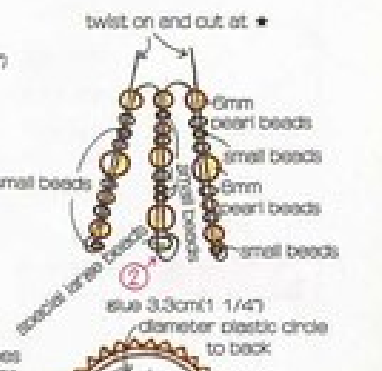

**4 HAT**

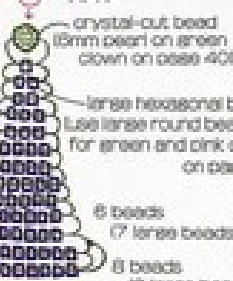

**5 FLOWER**

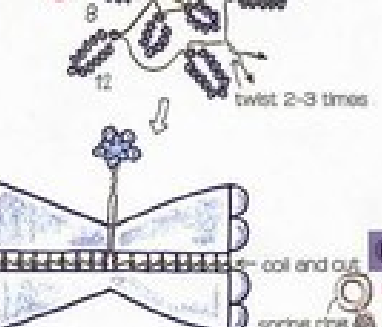

**6 BRACELET**

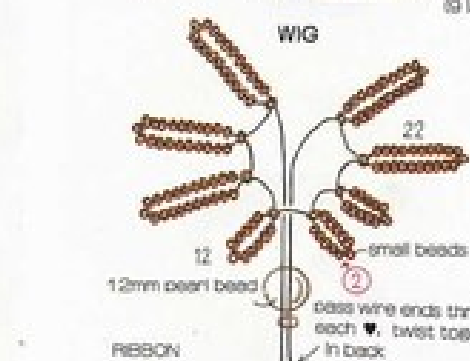
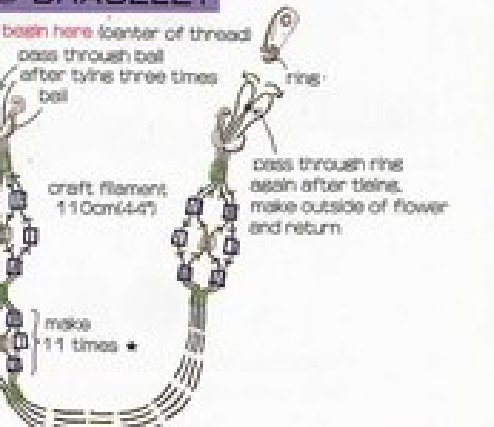

**7 RIBBON**

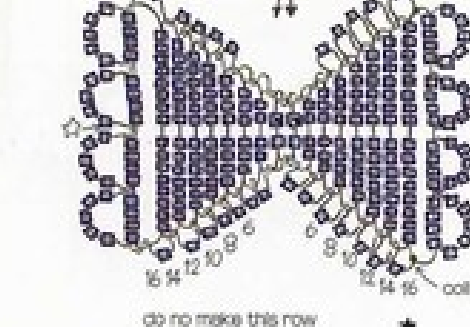

**8 BROOCH PIN**

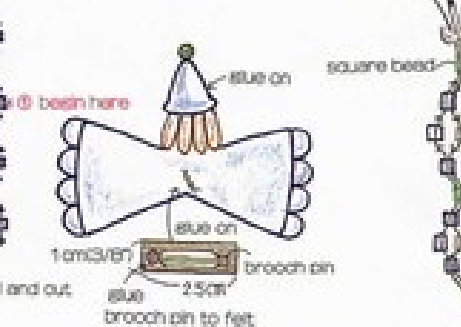

do not make this row if using large beads \*

CONTINUED ON PAGE 62

# BEAD BASICS

## TYPES OF BEADS

### BEADS



loose beads

### PEARL BEADS



### WOOD BEADS



### PARTS



## FINDINGS FOR ACCESSORIES



## WIRE, CRAFT FILAMENTS AND TOOLS

### WIRE

Use wire to make miniatures. 10m(33ft) rolls of various thickness: #28, #30, and #34 are sold for use in different crafts. Be careful not to bend the wire too hard or it may break.

### CRAFT FILAMENT

Use for necklaces or rings.

Glue on knots so they don't come off.

### SCISSORS AND PLIERS

Use Cutting pliers to cut thick wires and scissors to cut craft filament.

Chain nose pliers are useful for opening and closing jump rings.

### NYLON THREAD AND BEAD CORD

These are strong for beading and useful for accessories and embroidery as well.

### ELASTIC

Thin elastic is used for making bracelets and sleeve holders.

### BEAD NEEDLES

Needles for fine beads, accessories and embroidery.

### CRAFT GLUE

Glue used for beads and knots in crafts. If not available, use a glue that dries clear.



PRACTICE

# LAURA AND MARY



Practice with these lessons and learn the basics of beadwork.

- ① Cut wire to proper size. Start at middle of wire unless otherwise indicated.
- ② Wires must intersect inside beads for craft to lie flat.
- ③ Wire is drawn loose in pictures to see instructions clearly. Tighten it as you proceed.

**MATERIALS**  
 small round beads,  
 4mm curved beads,  
 3-cut beads,  
 8mm pearl beads,  
 #34 wire,  
 craft glue

Use small round beads unless otherwise indicated.

For crafts with several colors, see photos for proper selection.

① wire ① 75cm(30") ② 40cm(16")



begin at middle of wire ①

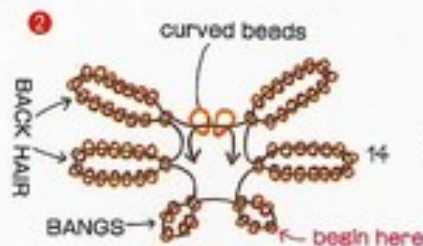

tighten wire to make hair

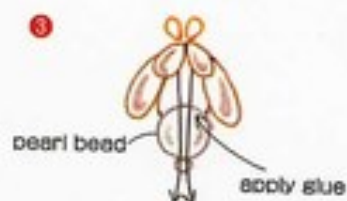

Pass through face pearl and neck pearl first. Put glue on top of head pearl and adjust hair. Use only glue that dries clear.

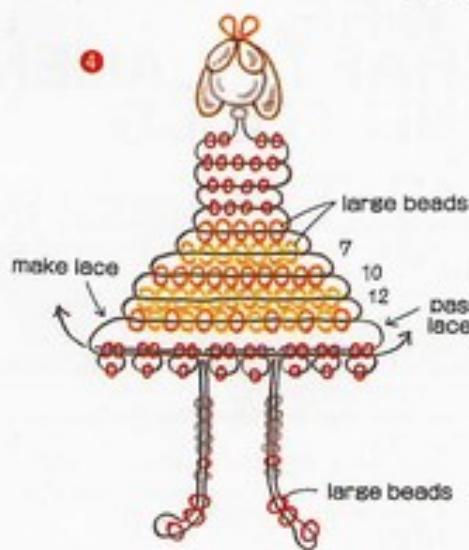

Tighten wire to make body, skirt, hem lace, and legs. Twist back to edge of body and cut.

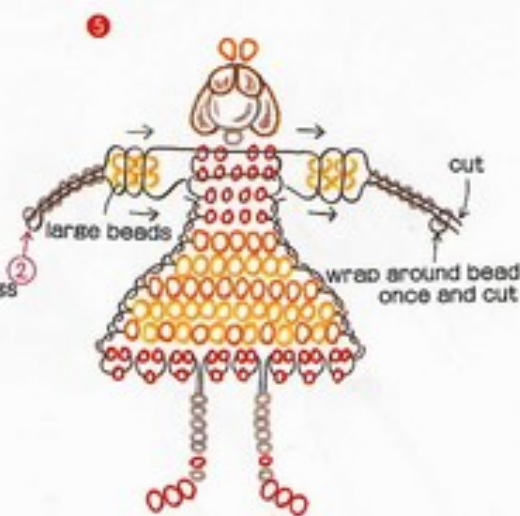

Make arms with wire ②. Begin from middle of wire, make the left side, pass two wires through body, and make right side.

Change color of beads according to the photo of Mary.





PRACTICE

# MAKE A BASKET!



- ① Let's practice making 3-d crafts with this basket. Make the flat bottom first, then the sides.
- ② Two wires pass through at points marked ★ and ☆. Follow the pattern carefully.
- ③ Make handle and flower. Twist the ends of the wires together and cut.

**MATERIALS** #34 wire  
small round beads,  
large round beads,  
4mm curved beads.  
Use small round beads  
unless otherwise indicated

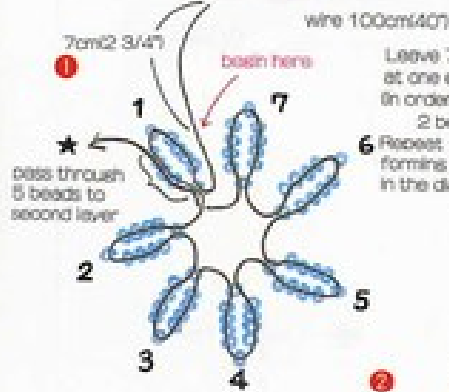

Leave 7cm(2 3/4") of wire at one end and start making 6 in order to make up for 2 beads at the end.  
6 Repeat form 7 times, forming a flower, as shown in the diagram.

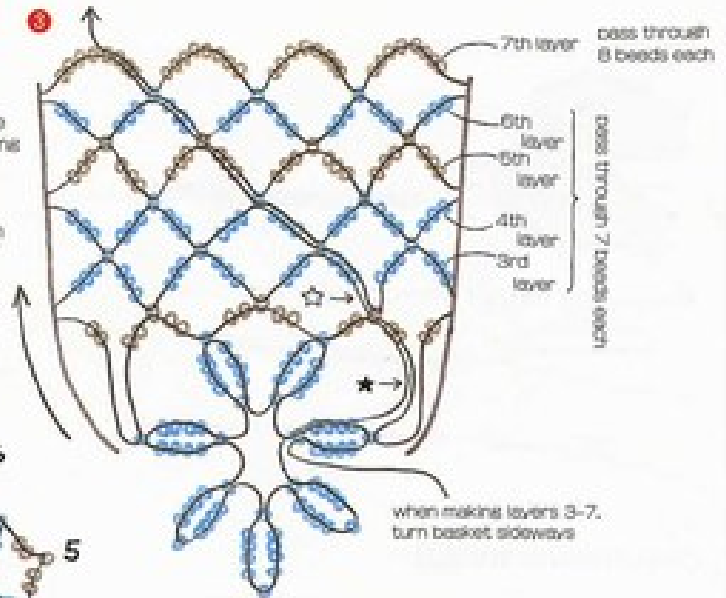
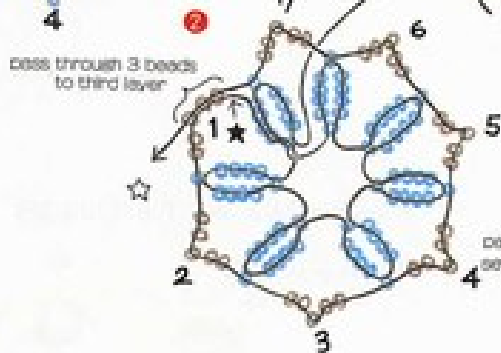

pass through 5 beads each, seven times for the second layer

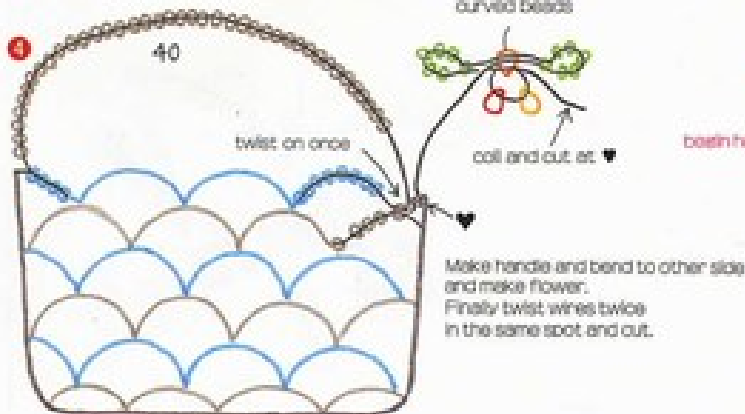

curved beads

BOTTOM OF BASKET

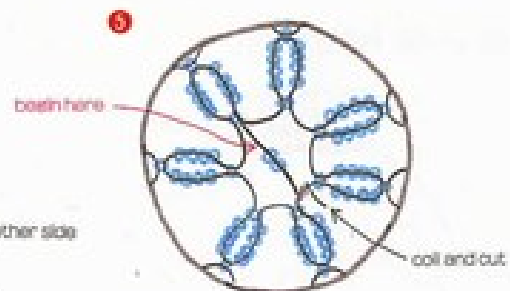

Pass wire left behind in step ① through 2 beads, attach to other side, and cut.



# POINTS TO REMEMBER

## MOVING BEADS

- Passing wire taut loose beads



- Wiring strung beads



- Passing thread through strung beads

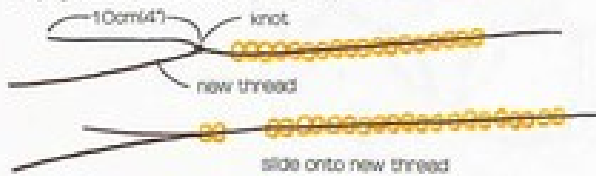

## CHANGING WIRES



## IF THE WIRE BREAKS!

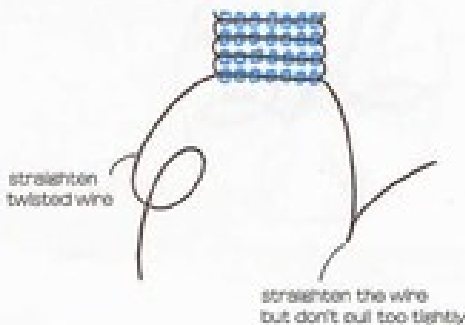

## FINISHING (WIRE)



## FINISHING AT FINDINGS



- bead tip

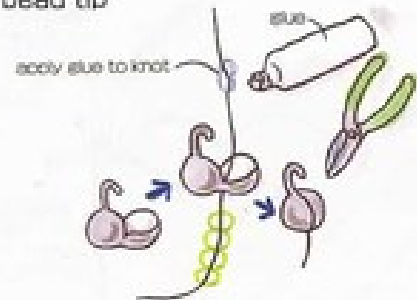

# CHRISTMAS FROM PAGE 17

## INSTRUCTIONS AND MATERIALS

small & large round beads, small beads, 4mm curved beads, large triangular beads, 3, 4, 5, & 7mm pearl beads, F4 wood beads, 5 & 8mm sequins, 8.4mm rhinestones, brooch pin, single-hole hat pin, earrings, 8mm bell, #28, 30 & 34 wire, plastic board, 20x25cm(8x10") black cotton cloth, 18x24cm(7 1/2"x 9 1/2") frame, blue.

Use large round beads unless otherwise indicated

### 1 CHRISTMAS TREE IN FRAME

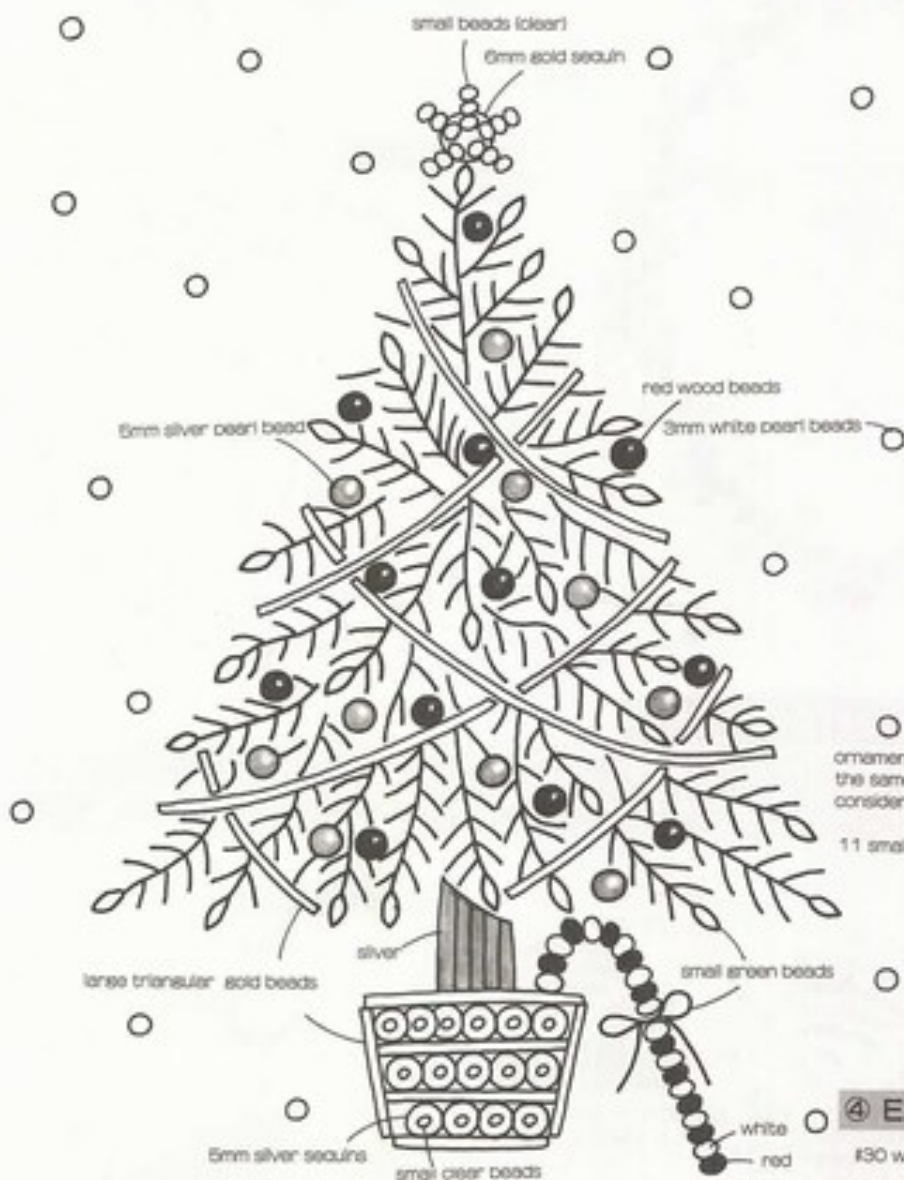

REFER TO BASICS OF BEAD EMBROIDERY ON PAGE 16

### 3 BROOCH

wire #28 100cm(40")  
#34 60cm(24")

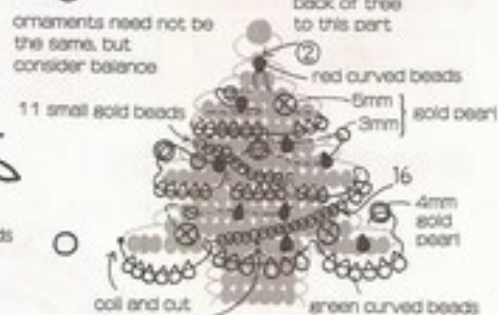
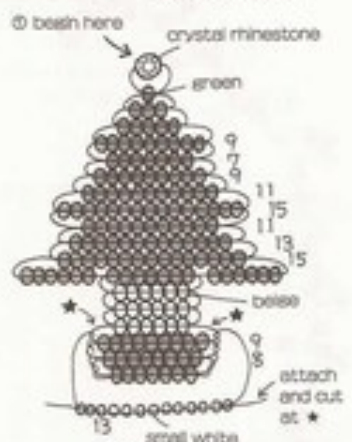

### 4 EARRINGS

#30 wire 40cm(16")

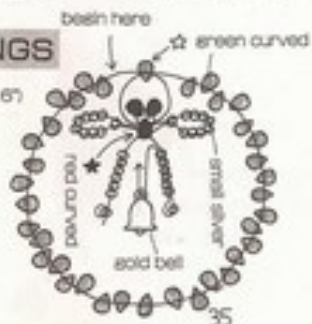

pass through in order \* and attach to earring backs



## 2 CHRISTMAS WREATH

wire © #30 140cm(56") © #28 30cm(12")  
 © #34 70cm(28") © #34 30cm(12")  
 © begin here: leave 7cm(2 3/4") of wire

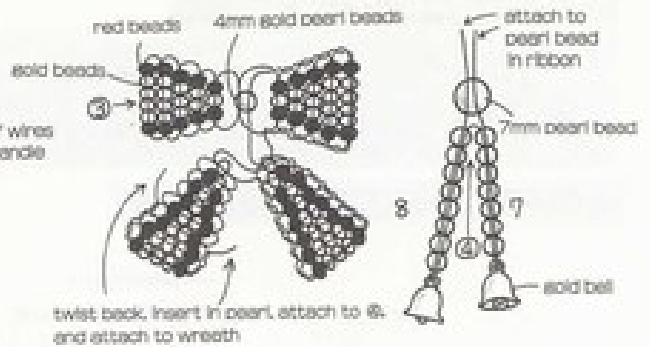
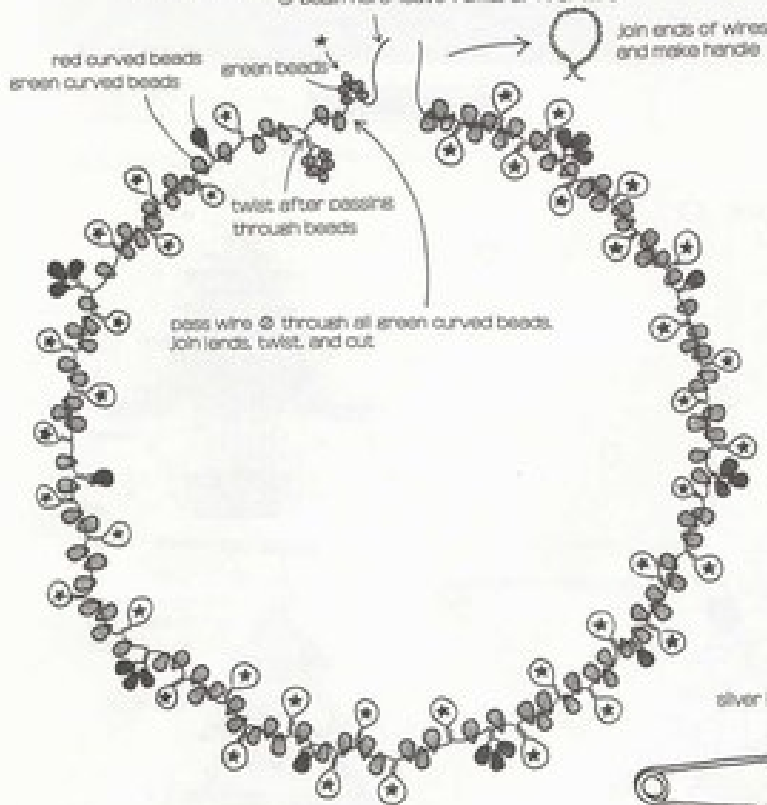

## 5 BROOCH

wire © #30 40cm(16")  
 © #34 30cm(12")

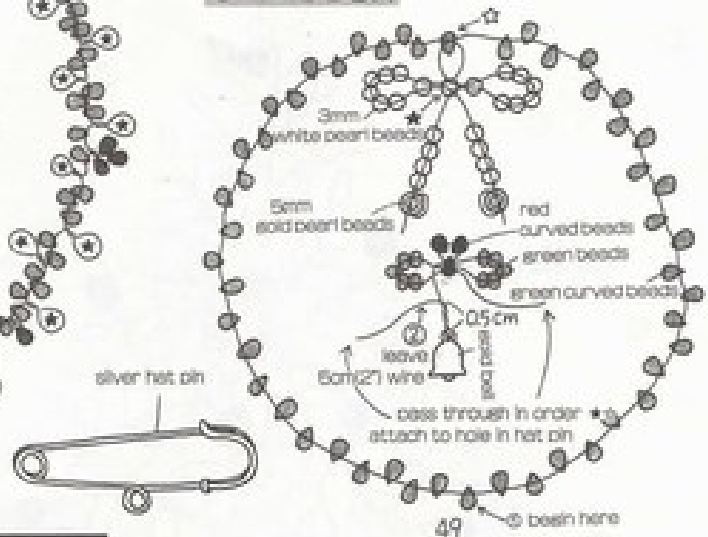

## SEA PARADISE CONTINUED FROM PAGE 28

### INSTRUCTIONS AND MATERIALS

small & large round beads, 4mm curved beads, 3m & 6mm bugle beads, 8mm pearl beads, 8mm sequins, #34 wire, clay, glue.

Use large round beads unless otherwise indicated

## 15 STRIPED SEA BASS

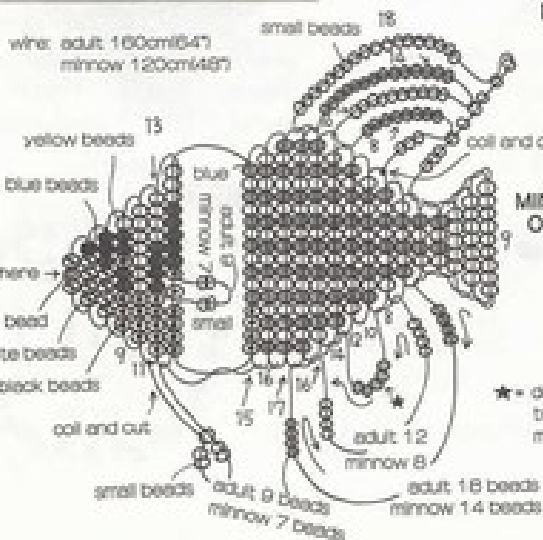

### MINNOW 13

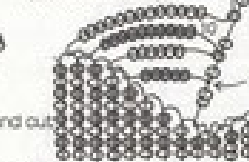

MINNOW IS MADE WITH ONLY SMALL BEADS

★ do not make in minnow, twist back and make ventral fin

## 4 WHALE

wire 90cm(36")

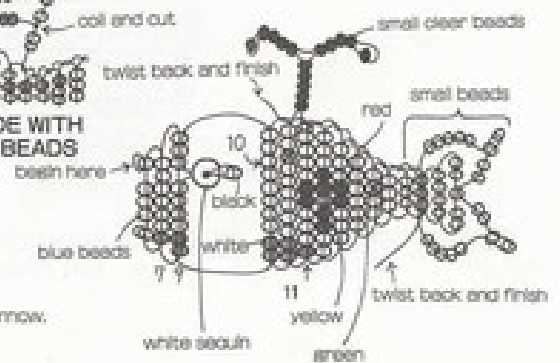

### 1 MERMAID

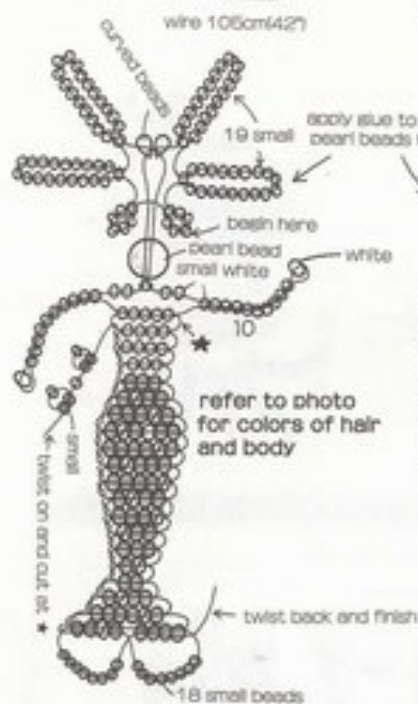

### 2 LITTLE MERMAID

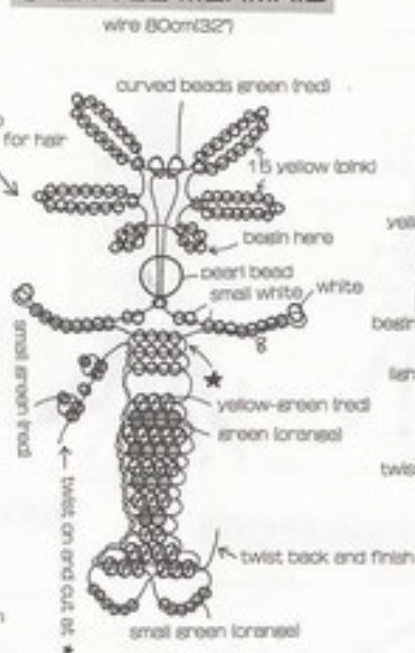

### 3 ANGEL FISH

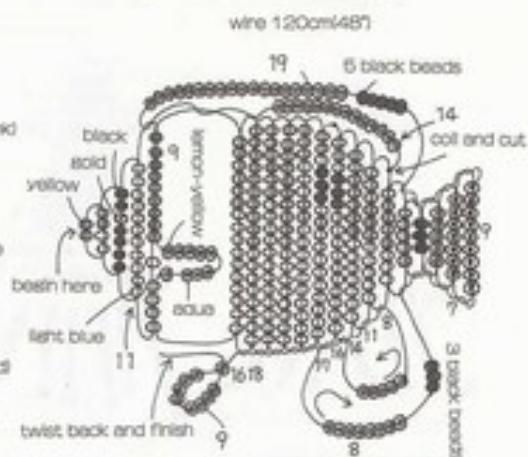

### 7 PINK FISH



### 14 LEATHERFISH

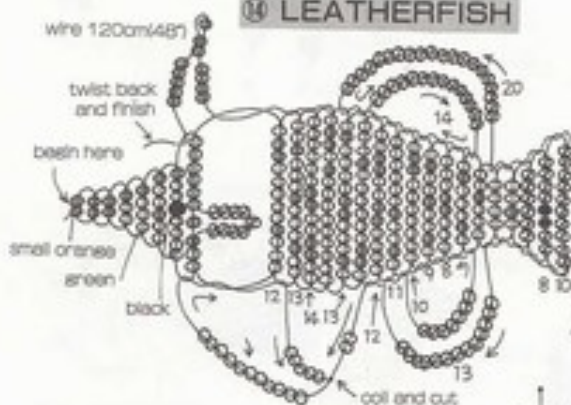

### 9 CORAL

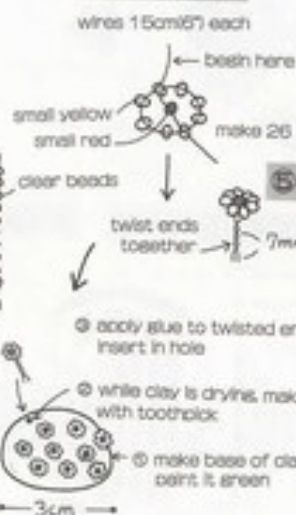

### 5 YELLOW-GREEN & BLUE FISH

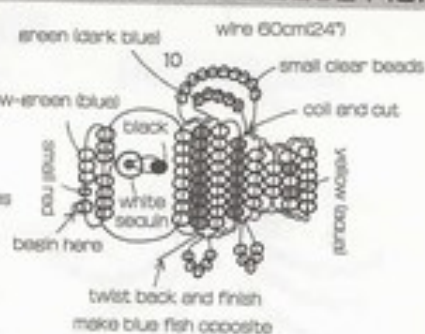

### 20 FLOUNDER

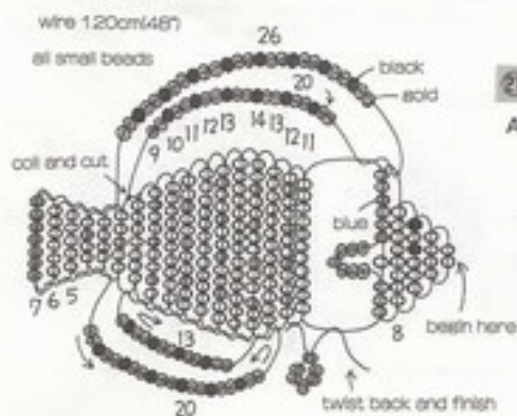

### 21 CRAB

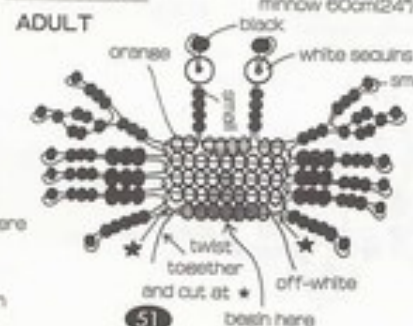

**MINNOW**  
except for pinchers, pass wire through beads the same as in adult crab

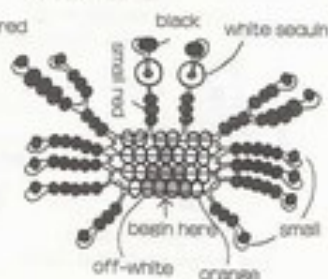

15 17 18 SQUID

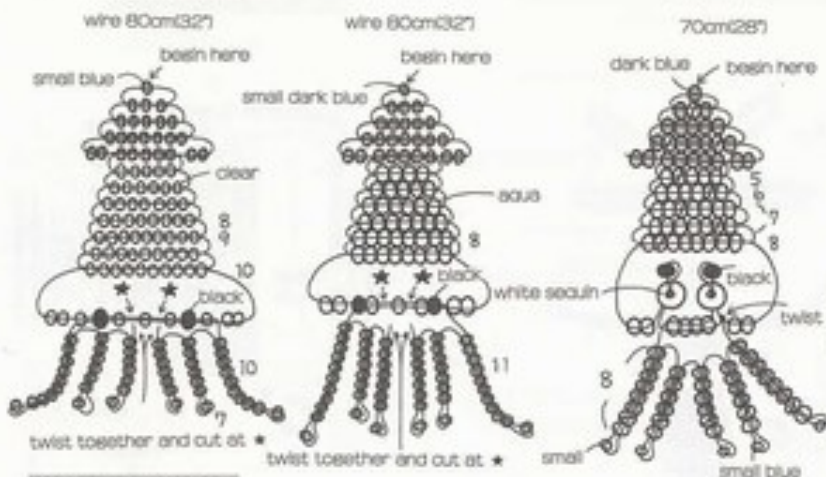

10 OCTOPUS

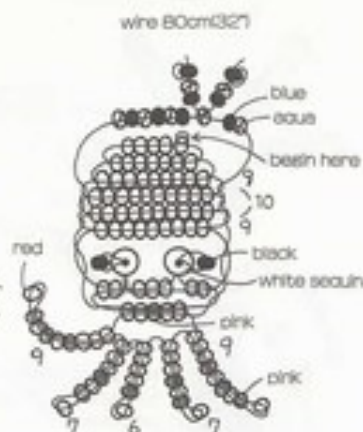

8 SEAWEED



11 ANGELFISH

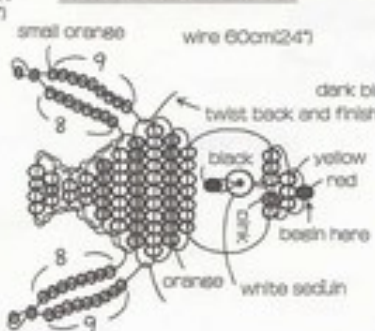

6 BLUE AND YELLOW FISH

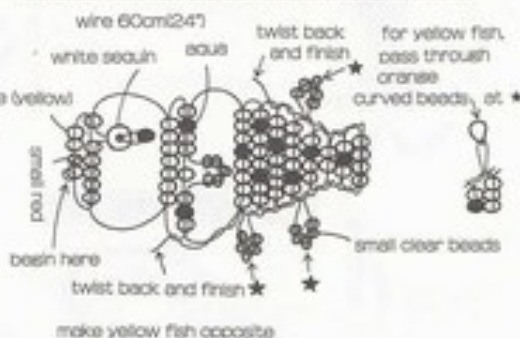

12 JELLYFISH

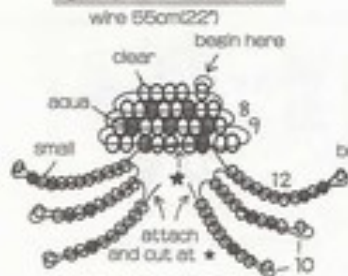

13 RED SNAPPER

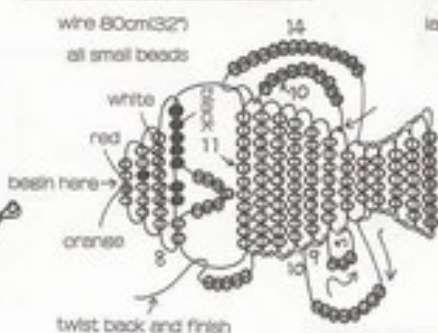

3 DOLPHIN

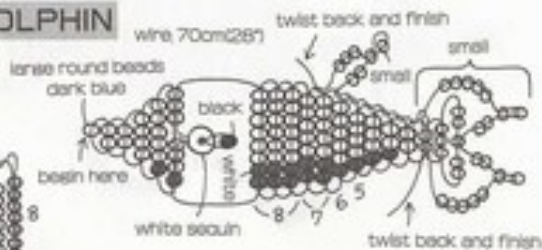

20 BLACK AND WHITE FISH

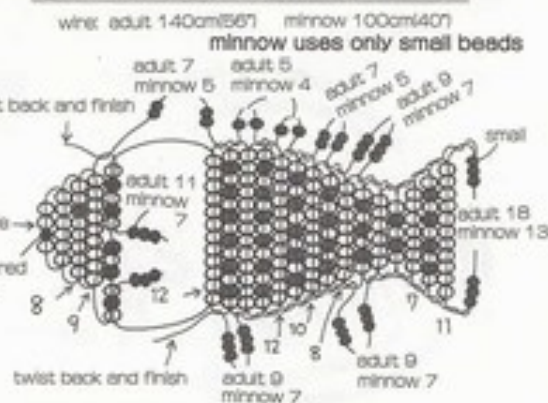

23 STARFISH

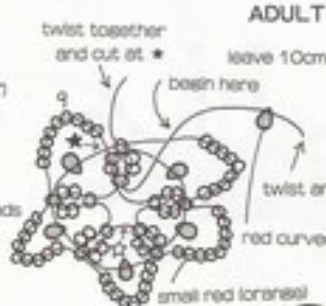
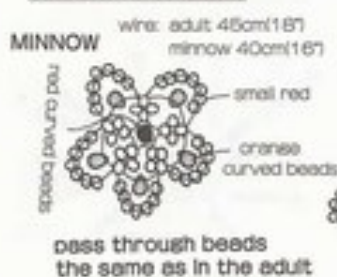

## NAMEPLATE CONTINUED FROM PAGE 30

### INSTRUCTIONS AND MATERIALS

small & large round beads, 4mm special large beads, 3mm curved beads, 5 & 10mm pearl beads, 4x8mm teardrop pearl beads, #30 & #34 wire, #20 bead thread, nameplate kit, glue.

Use large round beads unless otherwise indicated

### RABBIT

#34 wire ⑤ 50cm(20") ⑥ ⑦ 5cm(2 3/8")  
⑧ 50cm(20") ⑨ ⑩ 20cm(8")

⑪ #20 bead thread 10cm(4")  
⑫ #30 wire 15cm(6")

⑬ #20 bead thread 7cm(2 3/4")  
⑭ #30 wire 10cm(4")

⑮ #20 bead thread 8cm(3 1/4")  
⑯ #30 wire 30cm(12")  
⑰ #20 bead thread 1.5cm(5/8")

indent wire

refer to photo for colors

\* apply glue to top of nameplate refer to photo for placement

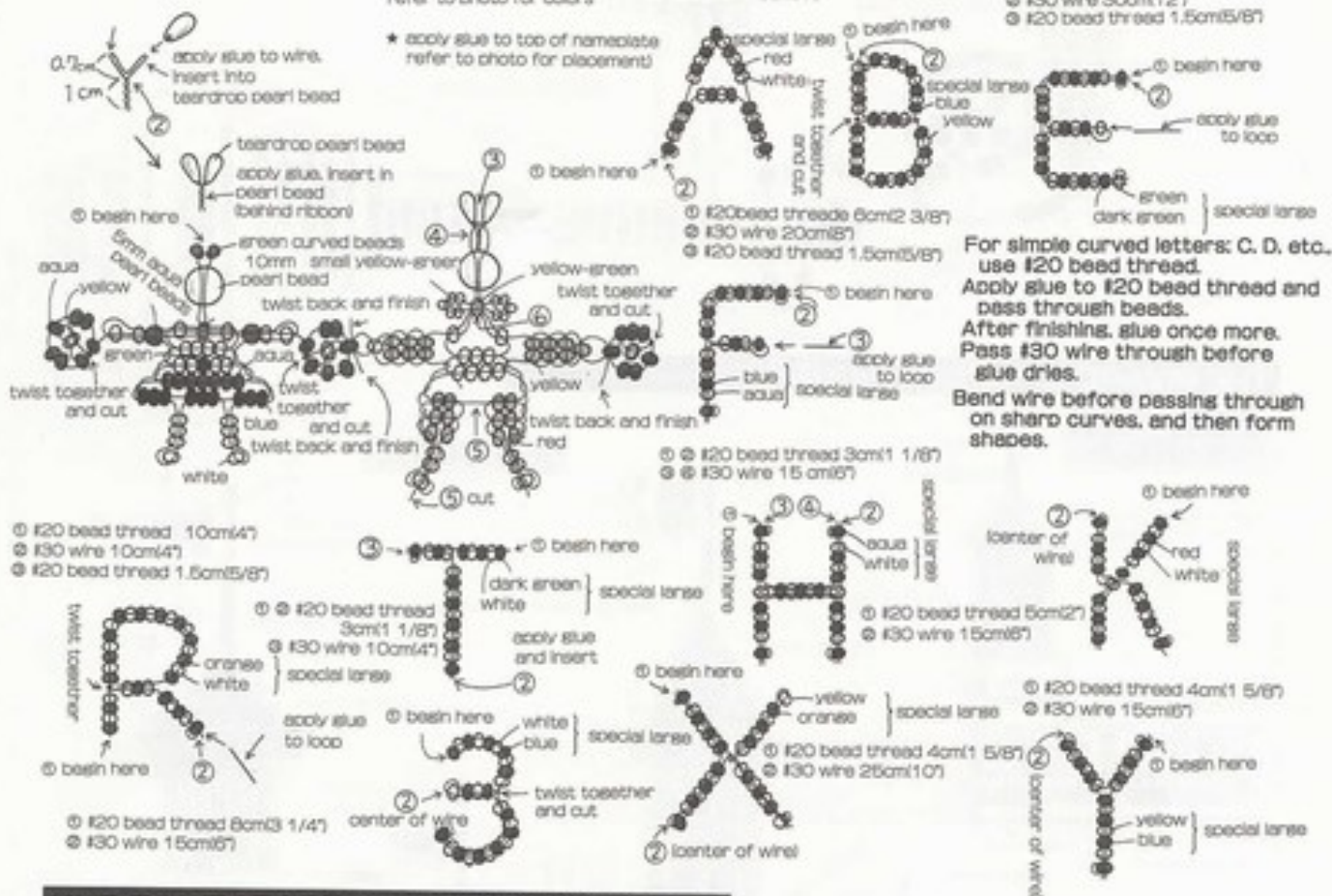

For simple curved letters: C, D, etc., use #20 bead thread. Apply glue to #20 bead thread and pass through beads. After finishing, glue once more. Pass #30 wire through before glue dries. Bend wire before passing through on sharp curves, and then form shapes.

## MUSICAL PARADE CONTINUED FROM PAGE 31

### INSTRUCTIONS AND MATERIALS

small & large round beads, 4mm special large beads, 3 & 4mm pearl beads, 8mm baroque pearl beads, #28 & #31 wire, #20 bead thread, glue

Use large round beads unless otherwise indicated.

### ⑧ TREBLE CLEF

#20 bead thread 25cm(10")  
65-70  
4mm special large beads

Bend the wire and form the clef slowly. First apply glue to end of wire and pass through beads. Then cut glue on the other side and form.



### ② ③ ④ ⑤ MUSICAL NOTES

wire A 30 cm(12")  
flower musical note - #28,  
pearl musical note - #31

small yellow-green  
small aqua  
baroque pearl bead  
bead here (center of wire)



wire B 40cm(16")

flower musical note - #28,  
pearl musical note - #30







17 SHELF

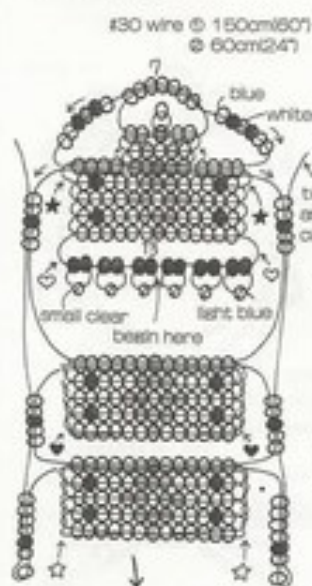

18 ARMCHAIR

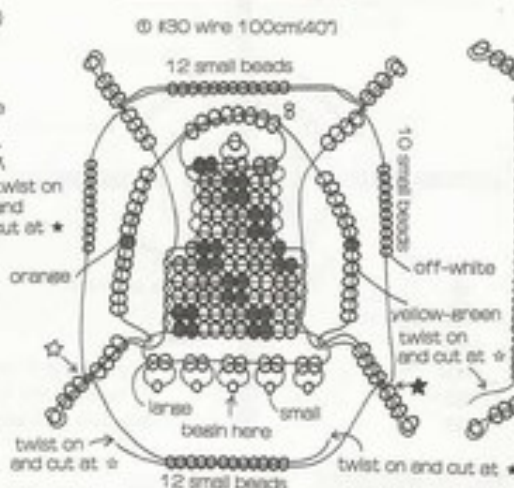

14 BED

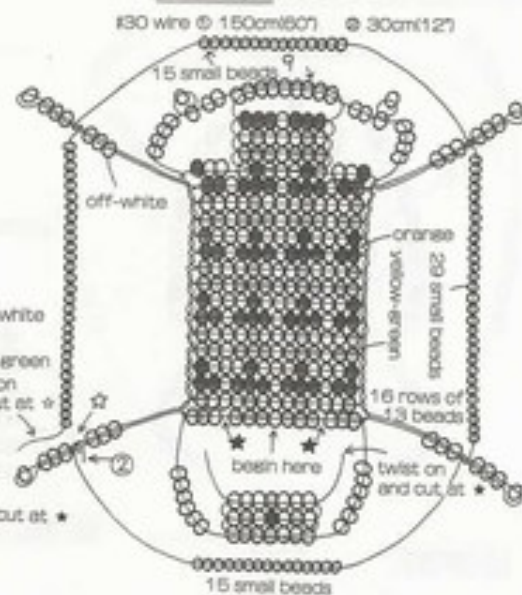

19 SOFA

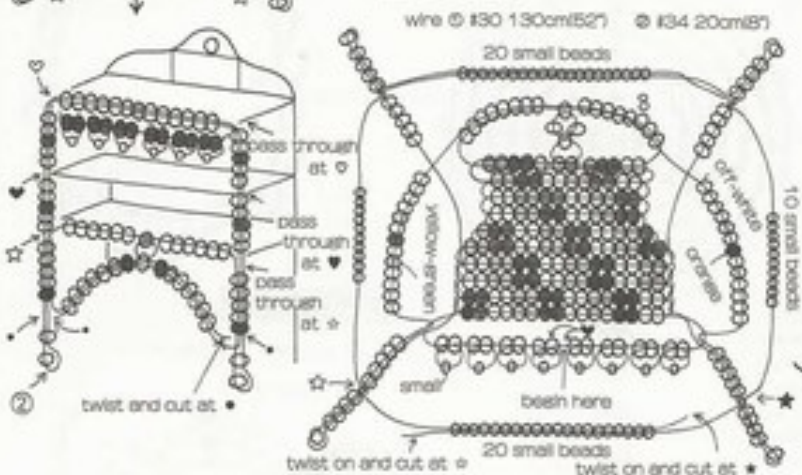

7 WINE



20 TABLE

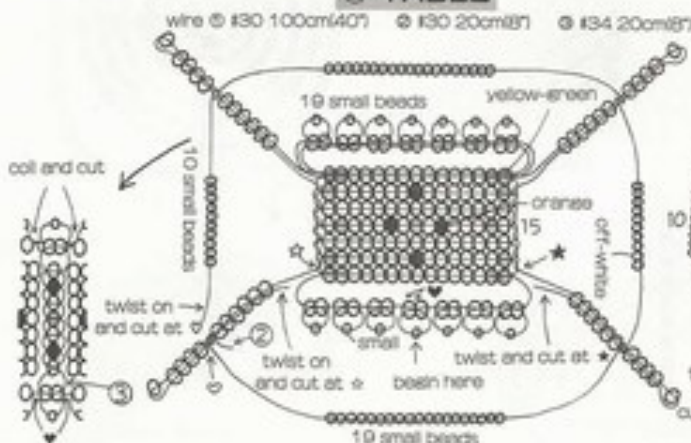

8 CHAIR

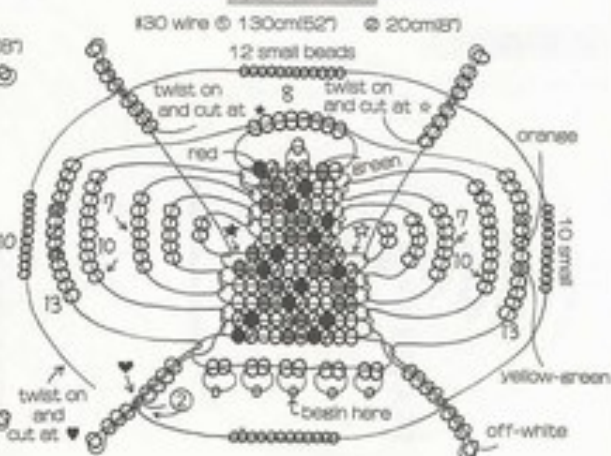

### 16 ROCKING CHAIR

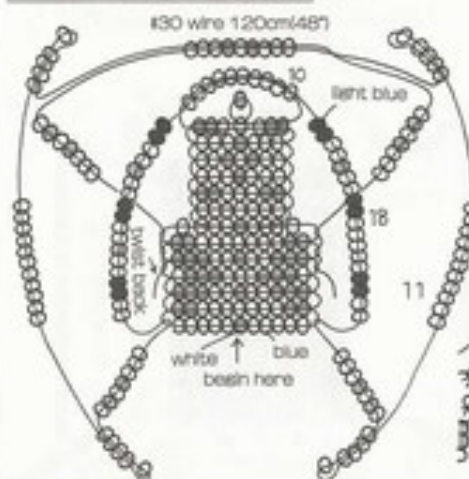

### 19 ROUND TABLE

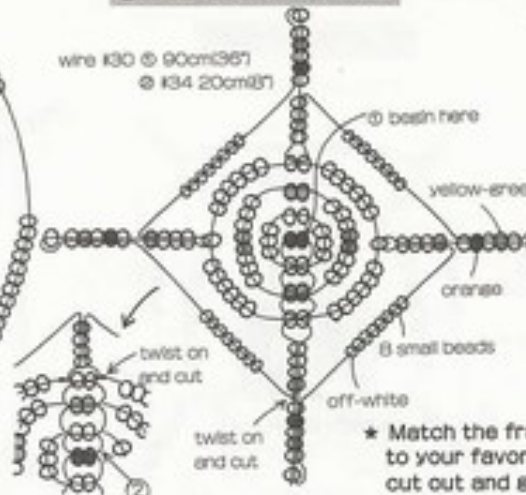

### 18 FRAME

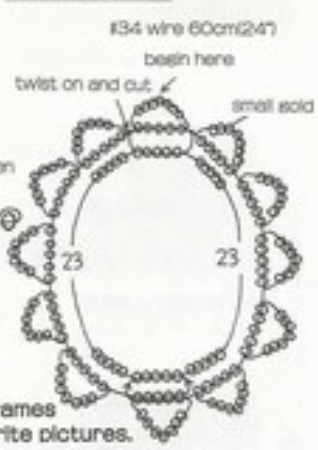

### 8 POT

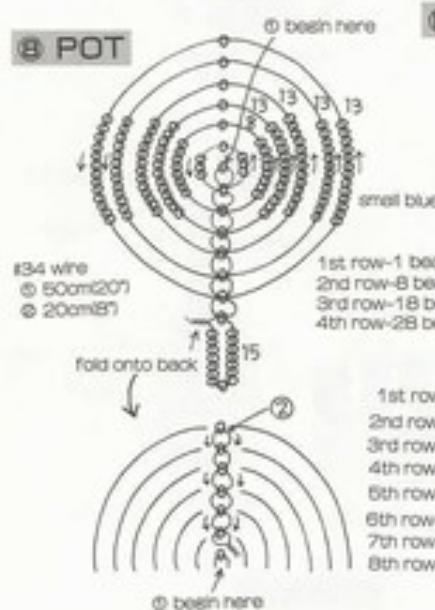

### 10 WASHBOWL

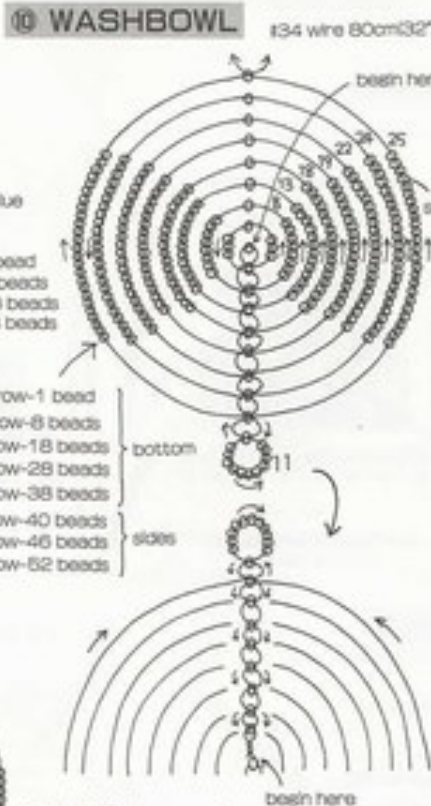

### 12 FRAME

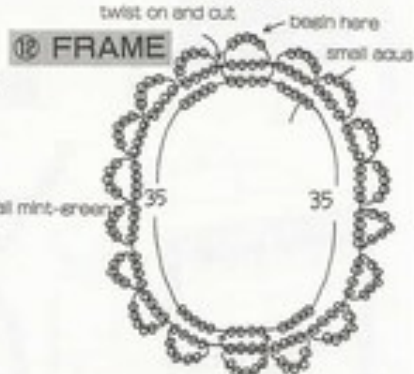

### 9 BUCKET



### 11 BASKET

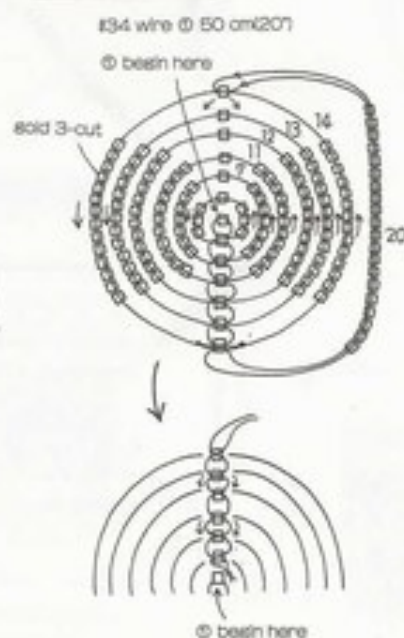

**12 13 THREE COURT LADIES**

#34 wire ① 40cm(1 6/8) ② 4cm(1 5/8)  
③ 35cm(1 4/7) 2 pieces ④ 20cm(8)

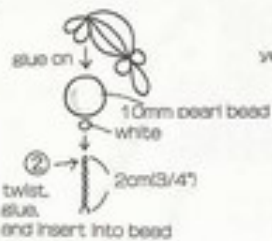
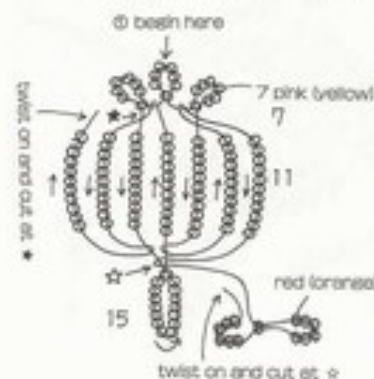

**FLLOWER** twist on and cut  
**SWEET SAKE** 10 acid beads

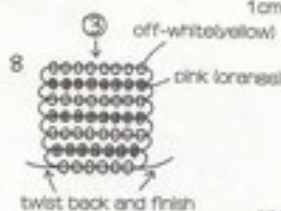

make base of clay, make hole with toothpick, and let dry

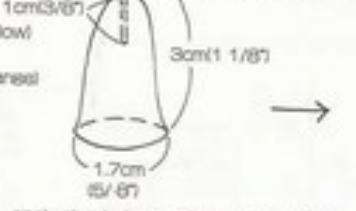

apply glue to base, wind string beads around base continuously from bottom to top  
see emperor on page 15



**14 FOLDING SCREEN**

#34 wire 4 pieces 120cm(4 8/7) each

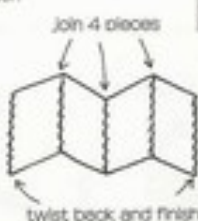
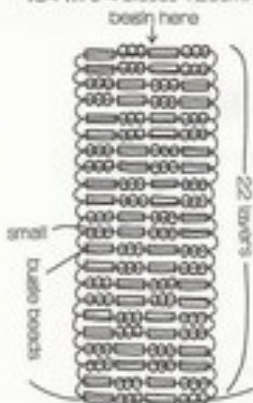

**15 RICE CAKES**

#34 wire 100cm(4 0/7)



**16 LANTERNS**

WIRE ① #34 60cm(2 4/7)  
② #28 35cm(1 4/7)

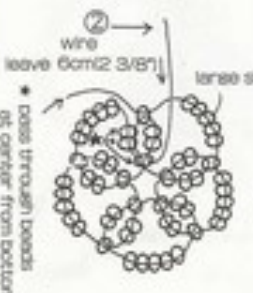
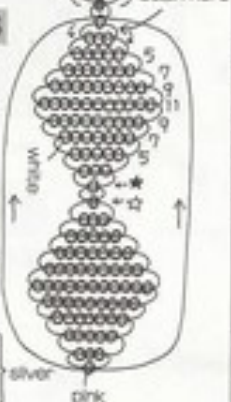
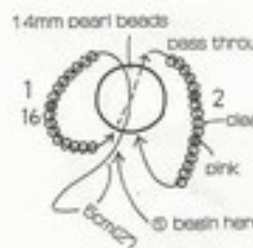

**GARDEN PARTY CONTINUED FROM PAGE 21**

**17 POTTED PLANT**

blue colored pearl beads  
#34 wire ① 30cm(1 2/7) ② 20cm(8/7) ③ 15cm(6/7) ④ 25cm(1 0/7) 3 pieces ⑤ 12cm(4 3/4) 9 pieces

make pot of paper clay, make holes and let dry  
glue string beads to pot apply glue to end of wires for leaves and flowers. insert in holes, and let dry  
make 15 holes 1cm(3/8) deep with toothpick



**18 POTTED PLANT**

#34 wire ① 10cm(4/7) 4 pieces ② 30cm(1 2/7) 6 pieces

make 10 holes 1.5cm deep with toothpick



**13 POTTED PLANT**

- #34 wire
- 20cm(8")
- 30cm(12") red 4 pieces
- 20cm(8") 7 pieces

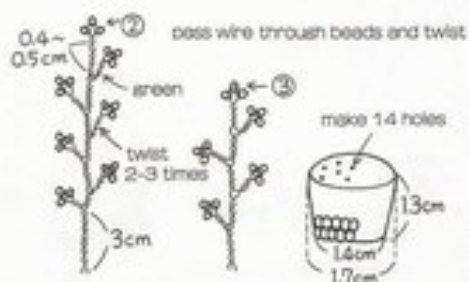

**14 LOVE SEAT**

#28 wire 120cm(48")

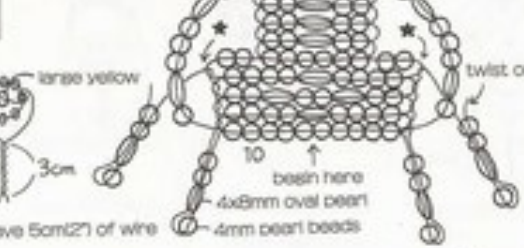

**15 TABLE**

#28 90cm(36")  
#34 15cm(6")

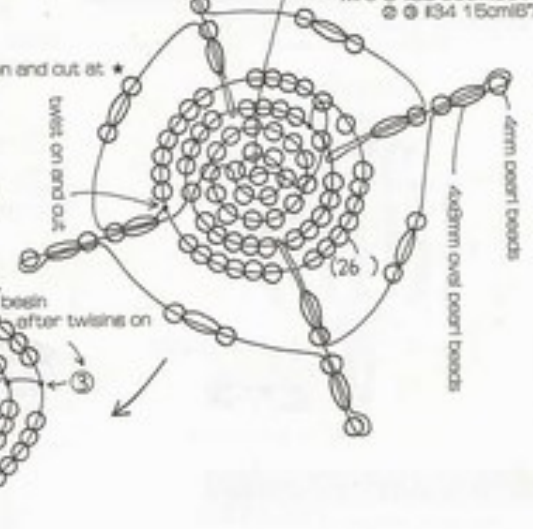

**RABBIT FAMILY CONTINUED FROM PAGE 25**

**16 SIDE TABLE**

#30 wire 75cm(30")

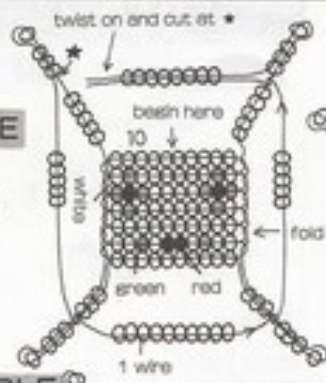

**17 ROUND TABLE**

wire #30 110cm(44")  
#34 20cm(8")

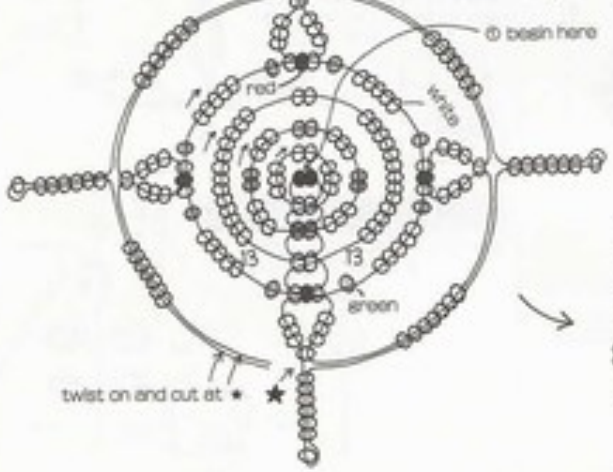

**18 BED**

wire #30 145cm(58")  
#34 30cm(12")

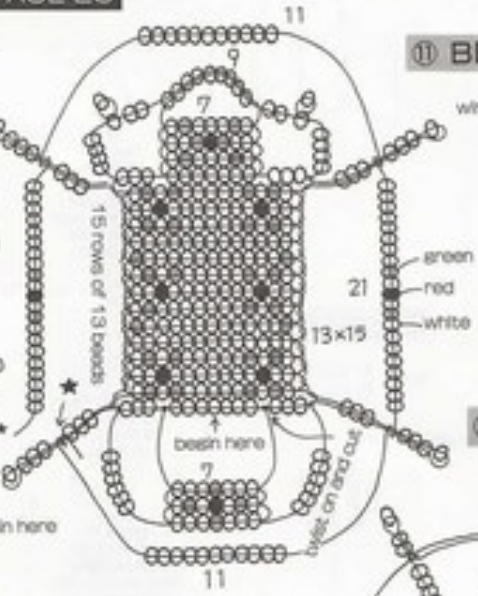

**19 ARMCHAIR**

#30 wire 100cm(40")

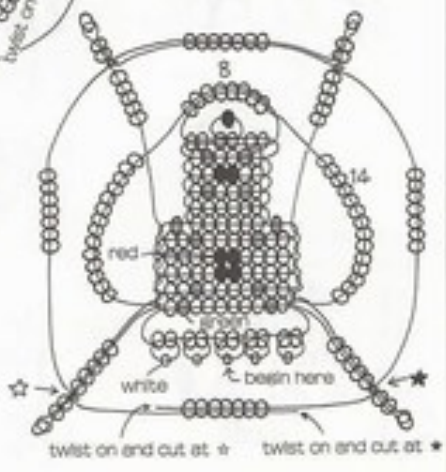

13 PARFAIT GLASS

wire @ 80cm(32") @ 25cm(10")  
small wire 1.5cm(5/8")

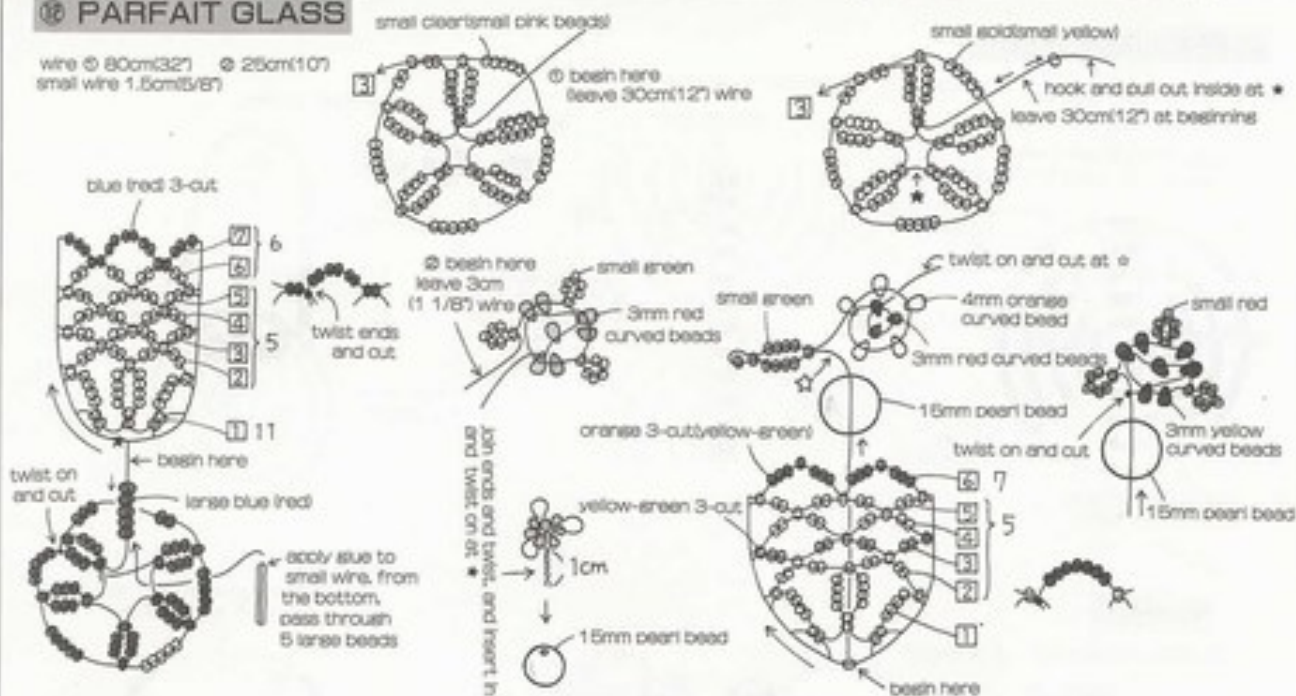

14 ROUND CAKE

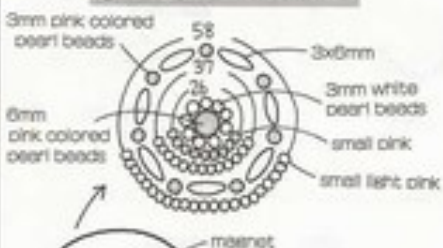

apply glue to center of 3cm(1 1/8") meant, attach 6mm colored pearl bead  
next, surround with 3mm pearl beads  
apply glue around this

thread small round beads, small hexagonal beads, and 3-cut beads  
number of beads needed depends on length of thread  
use a toothpick to position other beads for gluing



15 STAR-SHAPED CAKE

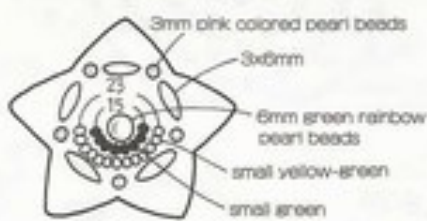

16 HEART-SHAPED CAKE

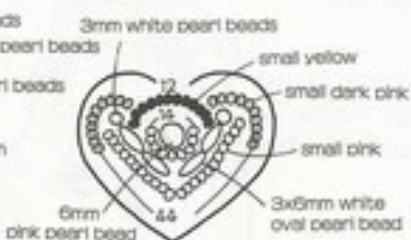
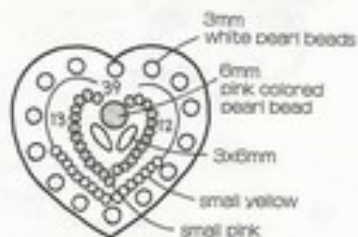

**9 SHOULDER BAG**

134 wire @ 60cm(24") @ 55cm(22") @ 25cm(10") @ 15cm(6")

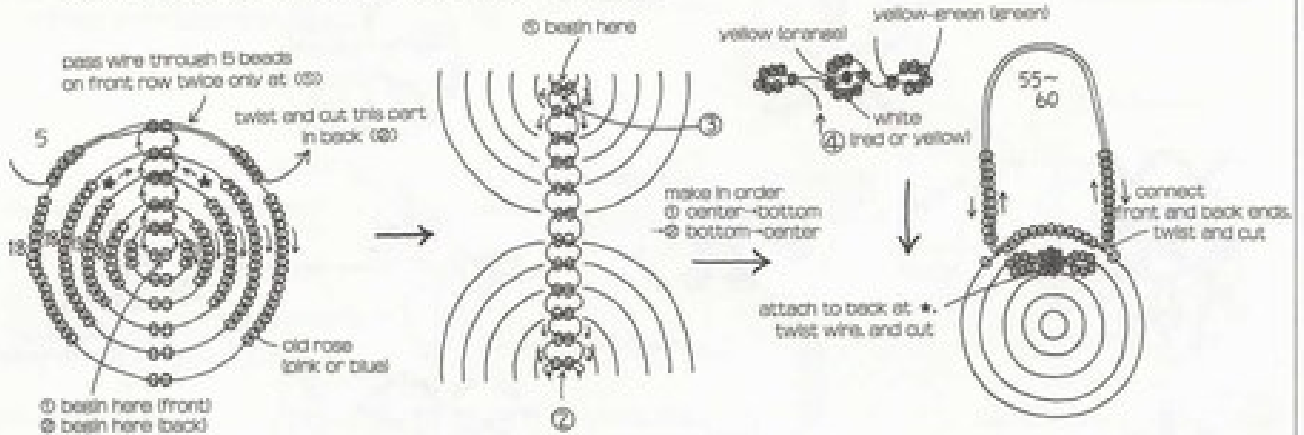

**8 HAT**

134 wire @ 90cm(36") @ 30cm(12")

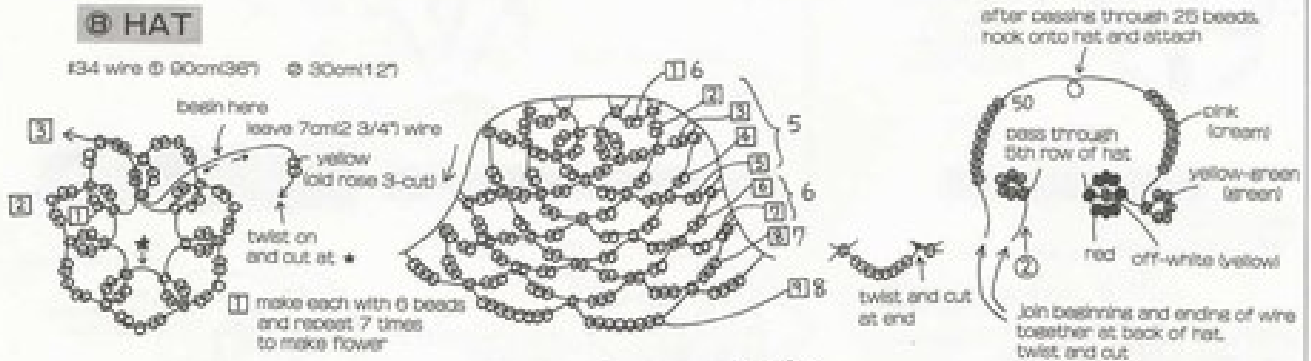

**A MERMAID IN A BOTTLE?!!**

Use a large Jar, hang with craft filament

tape to inside of lid

Place clean sand, starfish, and shells in Jar



**USE YOUR IMAGINATION!**

**A COZY HOUSE FOR RABBITS AND BEARS**

make with empty box or balsa wood

how about having fun making a little house



**7 BARRETTE**

134 wire ② ③ 60cm(24") ④ 20cm(8")

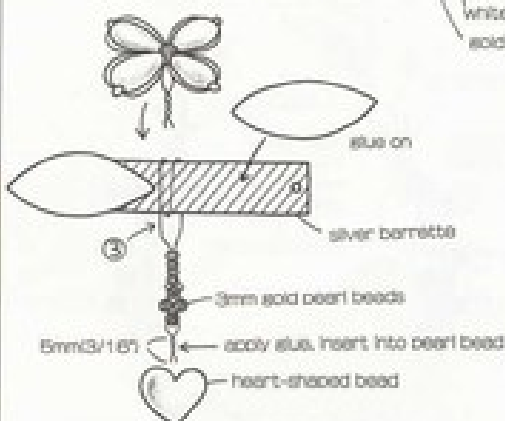
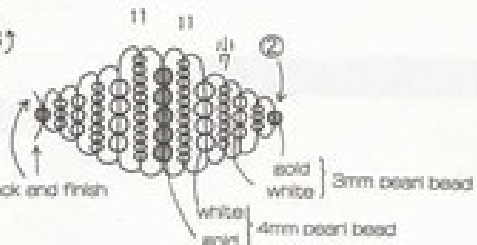
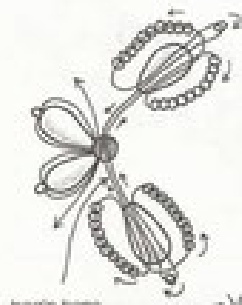
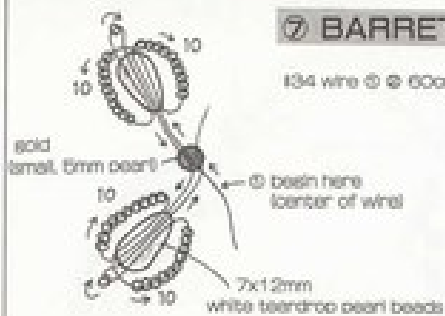

**8 NECKLACE**

130 wire ② ③ 60cm(24")  
④ craft filament 60cm(24")

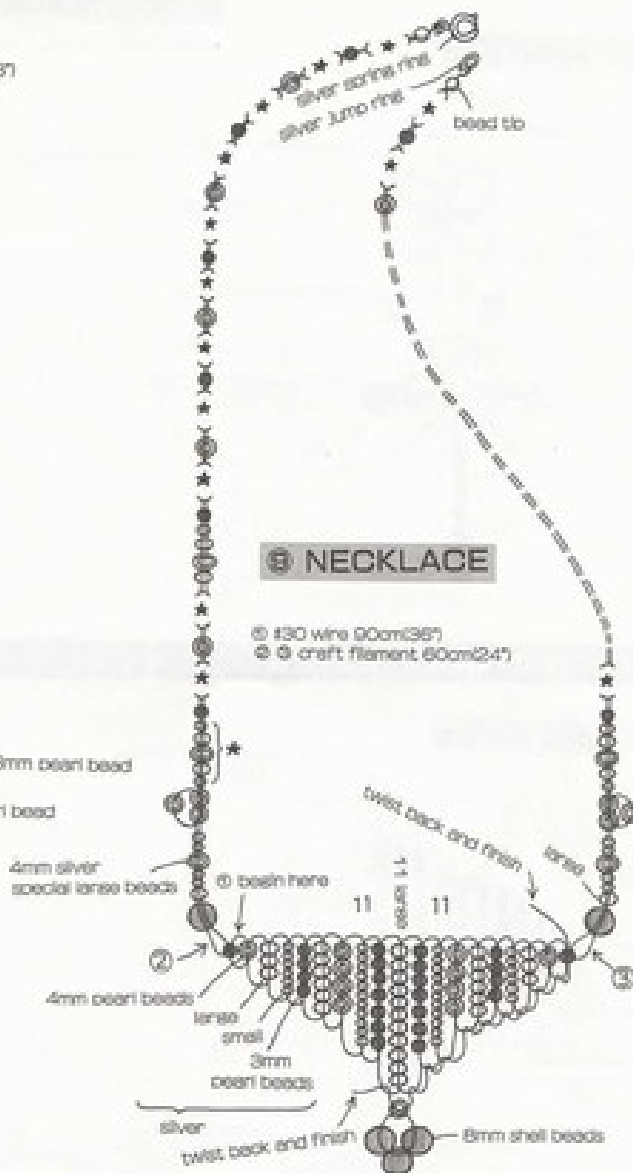

USE YOUR OWN IDEAS WITH THE CLOCK KIT!

MINI-FRAME



61

MOBILE

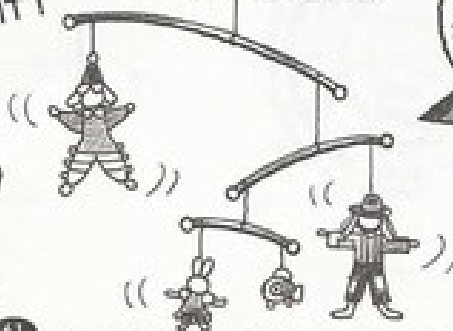

### 9 BROOCH

#34 wire 60cm(24")

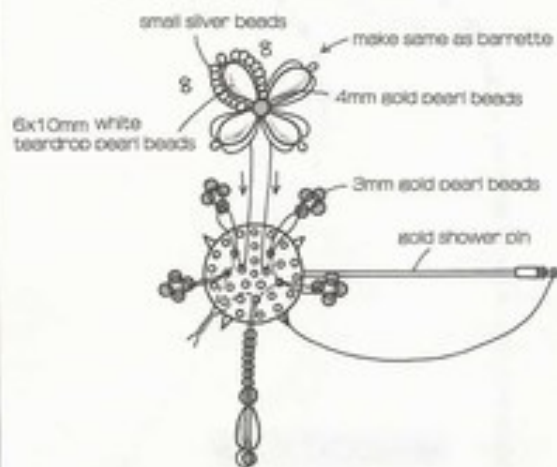

### 6 NECKLACE

nylon thread 320cm(126")



## POUCH AND ACCESORIES CONTINUED FROM PAGE 43

### 10 BARRETTE

#34 wire 80cm(32") 2 pieces  
80cm(32")

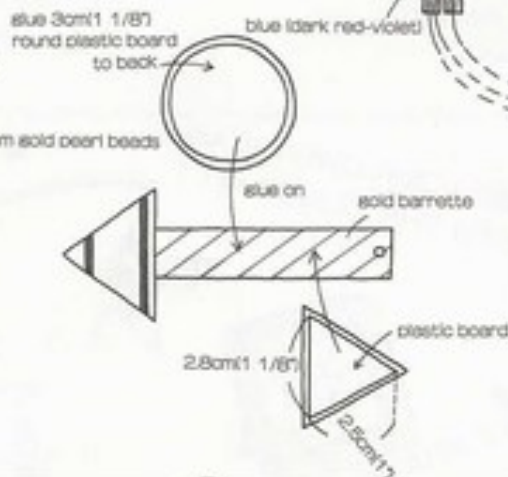
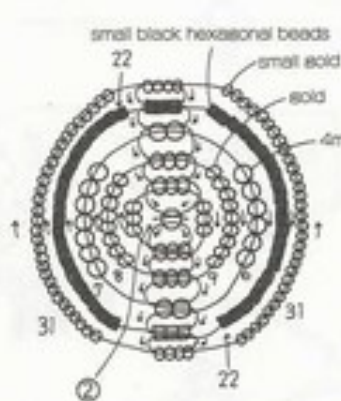
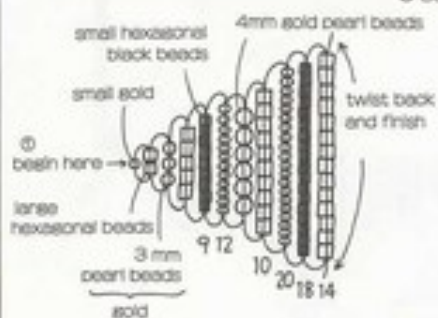

### 8 NECKLACE

craft filament 120cm(48") 100cm(40")

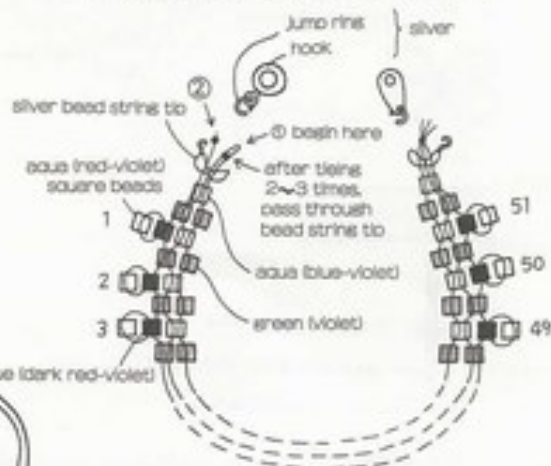



## 6 BARRETTE

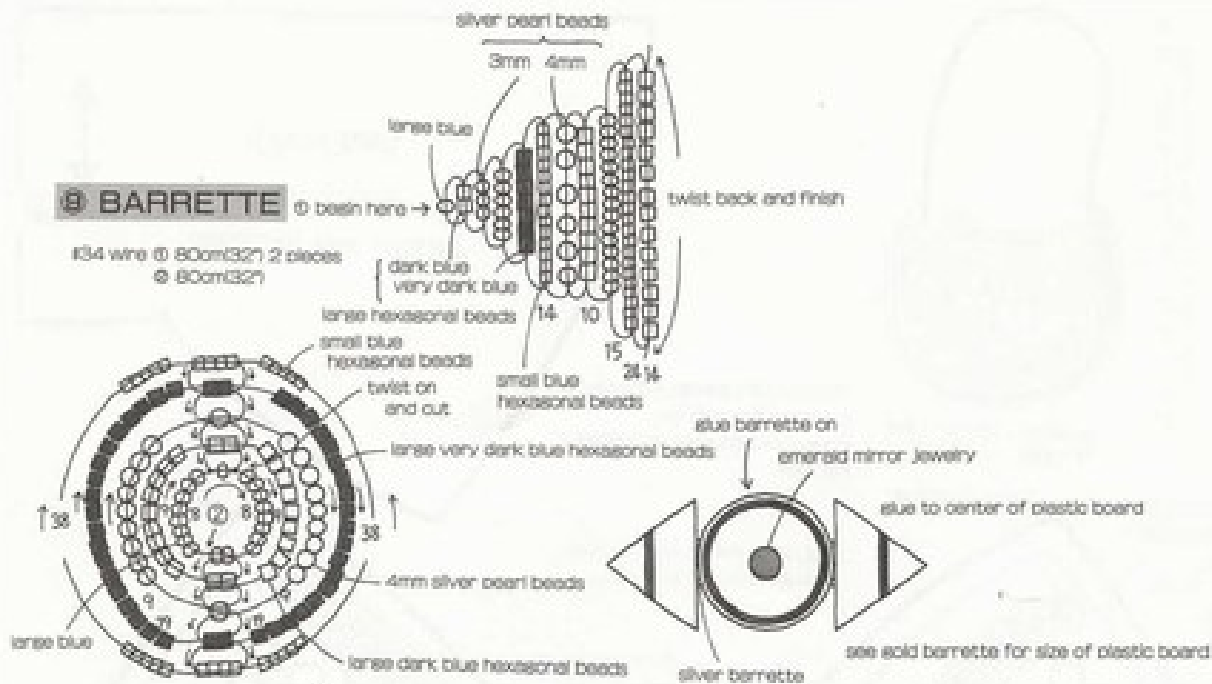

## 7 CAT POUCH

### MATERIALS (ALL SILVER, UNLESS OTHERWISE INDICATED)

50x50cm(20x20") black velvet  
black felt 20x20cm(8x8") 2 pieces  
large round beads  
large triangular beads  
58 6mm sequins  
19 6mm sequins

3 5x10mm design rhinestones  
3 4.6mm rhinestones  
2 8.4mm rhinestones  
6mm thick cord 100cm(40")  
134 wire 70cm(28")  
snap or magnetic clasp

see page 16 for embroidery instructions

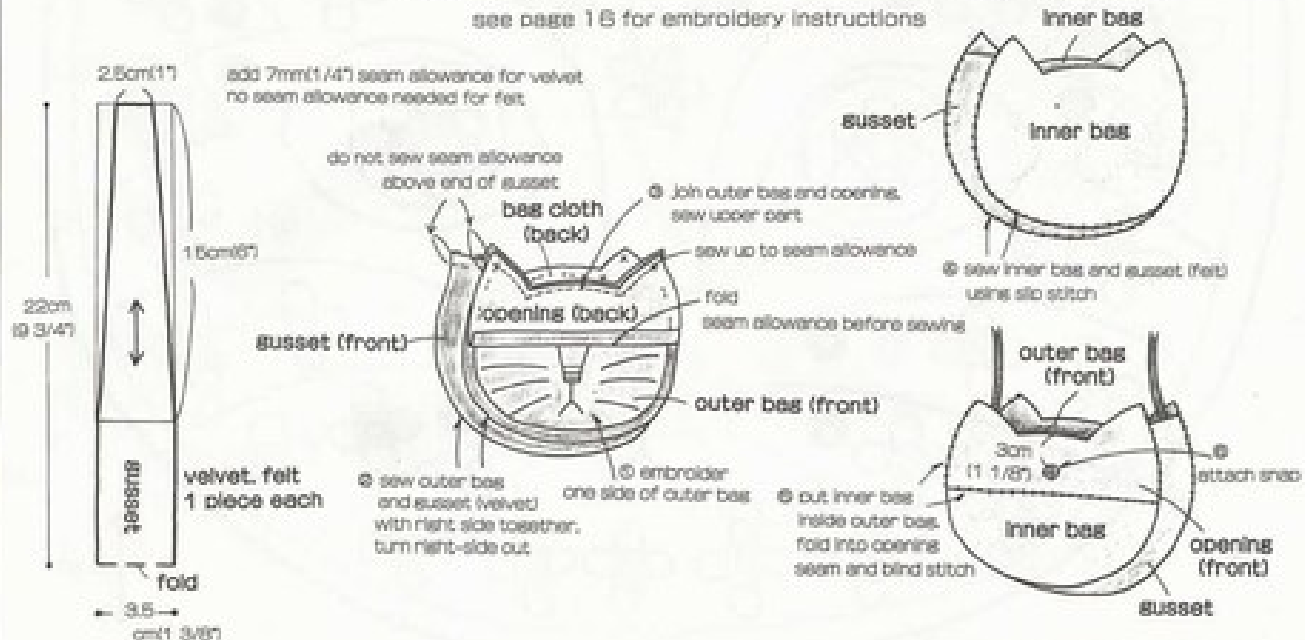

● fold susset allowance, cut 1 cm(3/8") of cord between velvet and felt, and bind stitch



susset (front)  
outer bag (front)

7mm(1/4") seam allowance needed for velvet.  
no seam allowance needed for felt

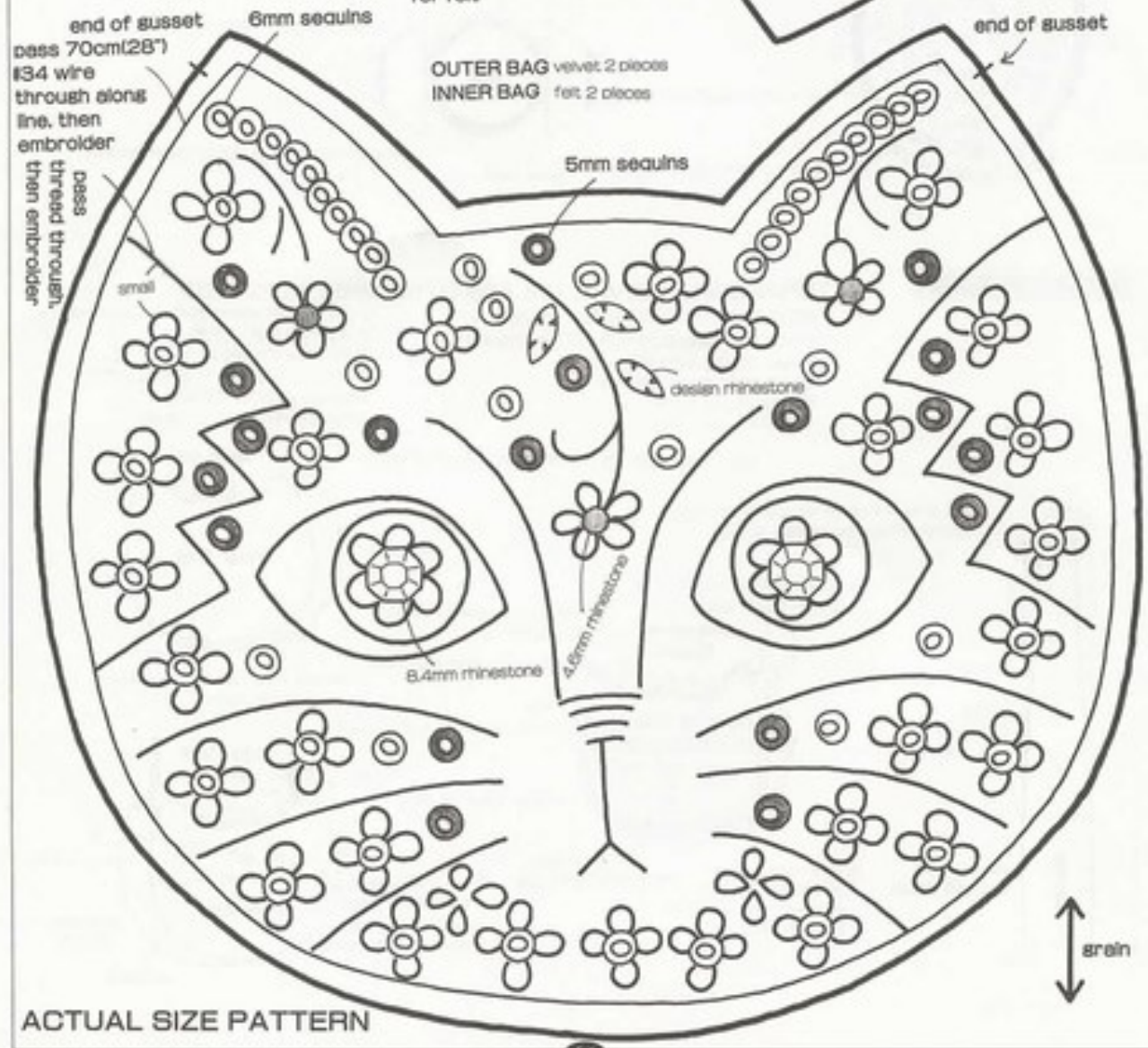
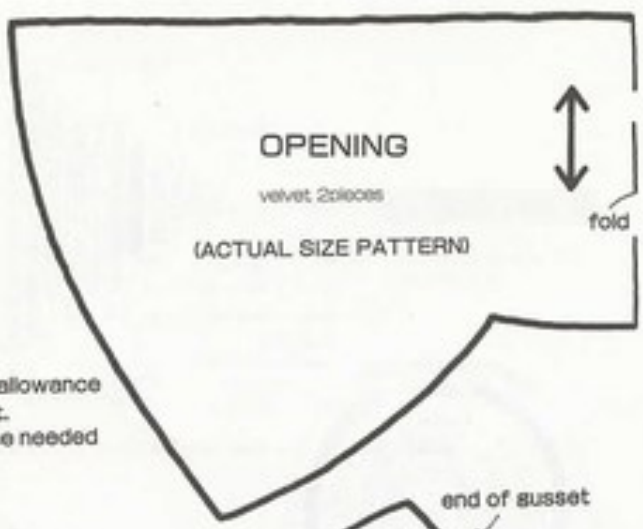

US\$ 16.00

*Basic*  
**Beadwork**  
*for Beginners*



ISBN 0-87040-972-7



ONDORI/JAPAN PUBLICATIONS

Printed in Japan