

Восстановить качество графики, увеличить
разрешение документа 300% без искажений.

10x10
www.wesew.ru

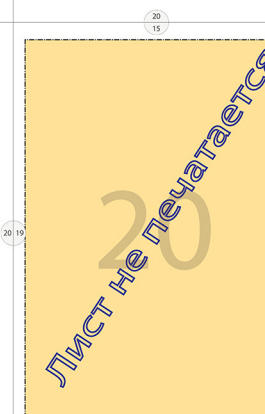

Обозначение (цвет линии)	Обхват груди	Обхват талии	Обхват бедер
— (black)	80	62	86
— (red)	84	66	90
— (green)	88	70	94
— (blue)	92	74	98
— (purple)	96	78	102

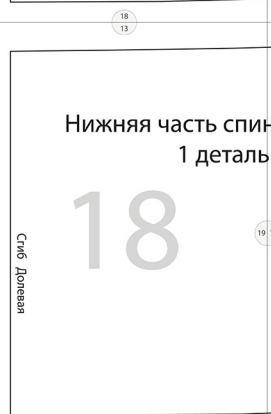
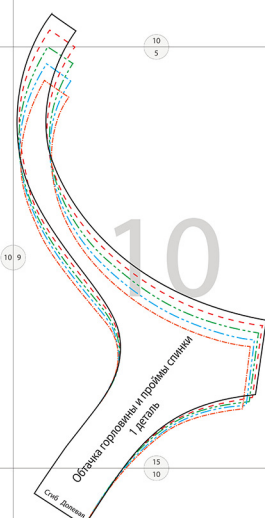
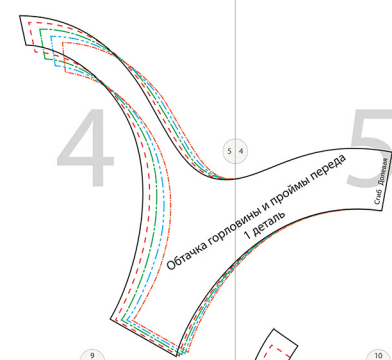
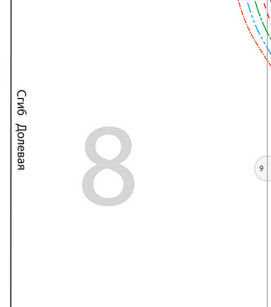
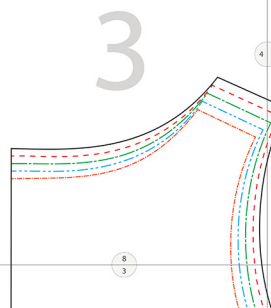
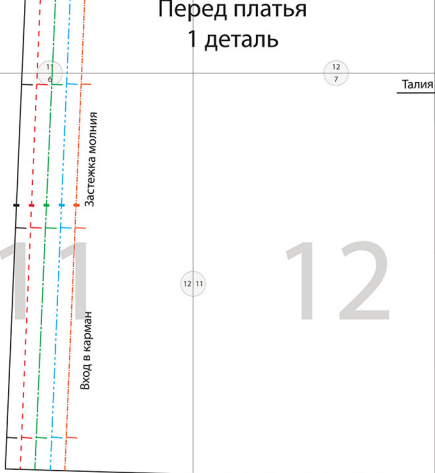
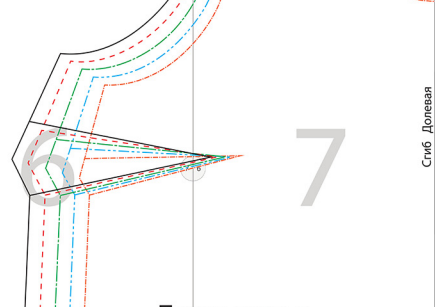
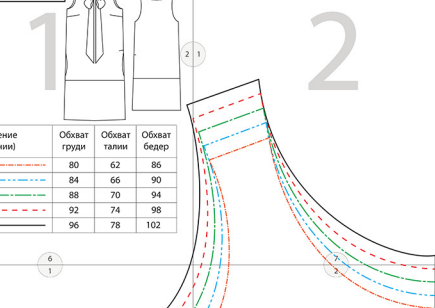

Лист не печатается



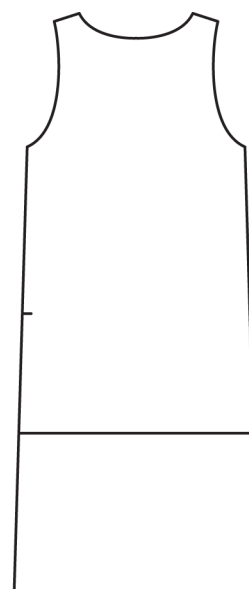
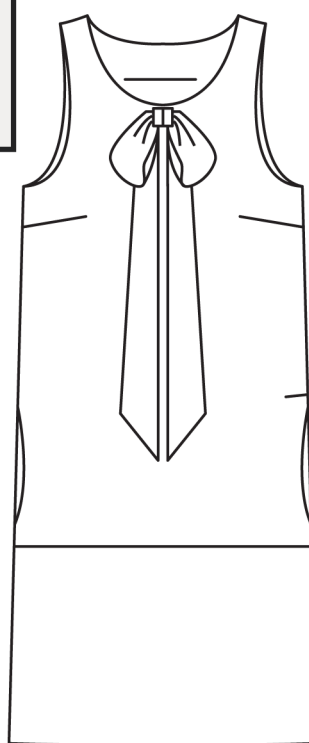

В настройках вашего принтера, укажите
печатать документ 100% (без масштабирования).

10x10

www.wesew.ru

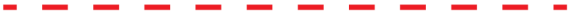

2

Обозначение (цвет линии)	Обхват груди	Обхват талии	Обхват бедер
	80	62	86
	84	66	90
	88	70	94
	92	74	98
	96	78	102

2

1

3

7

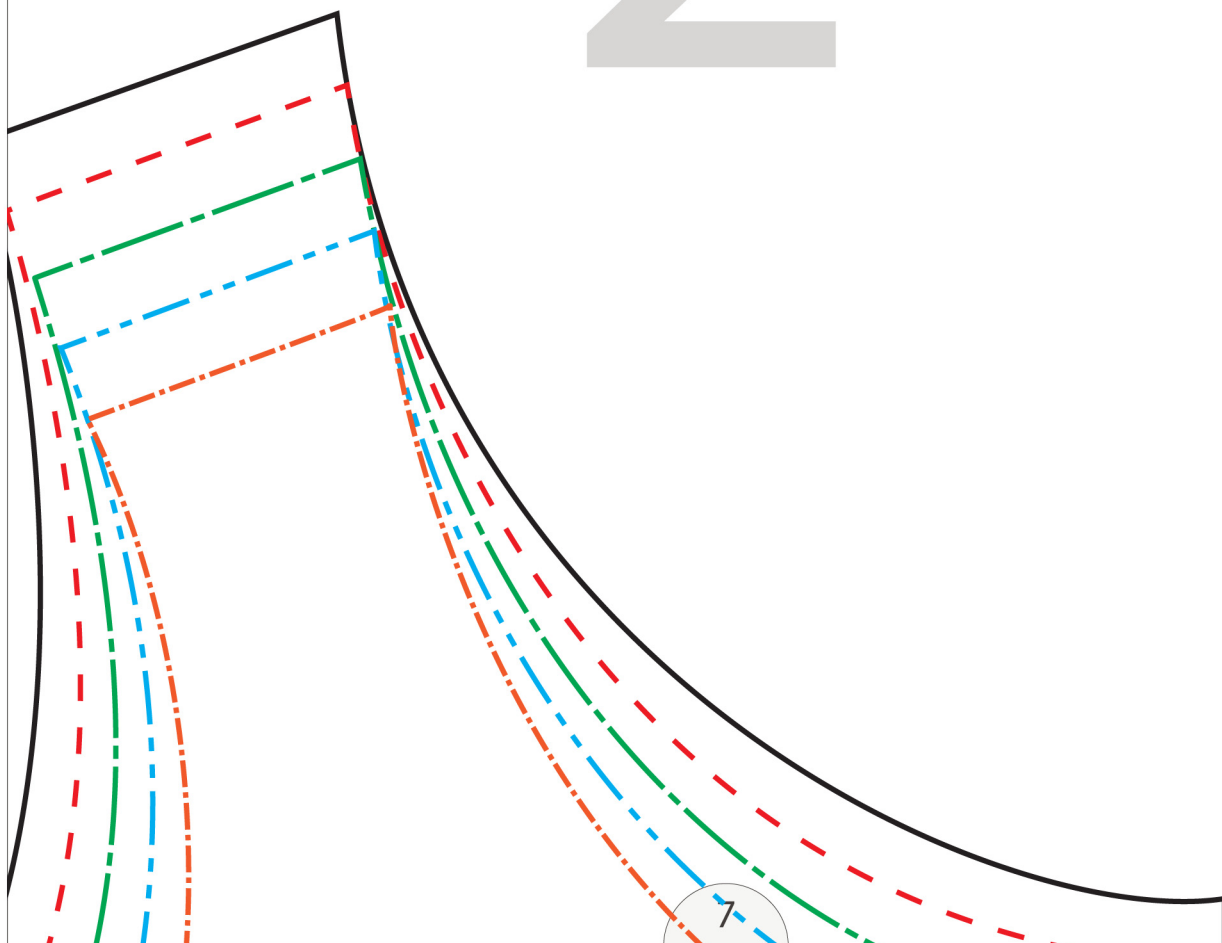

3

2

4

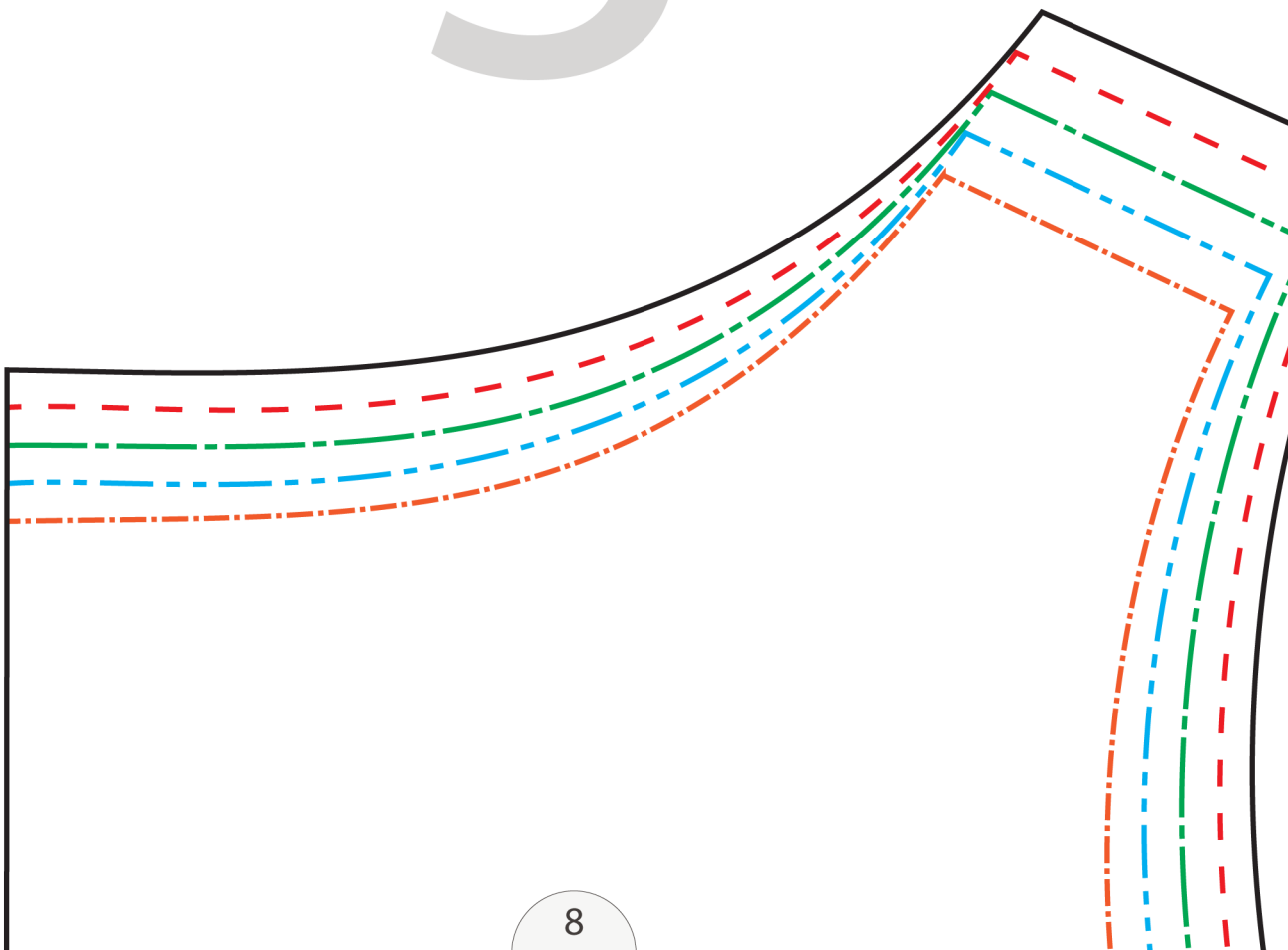

8

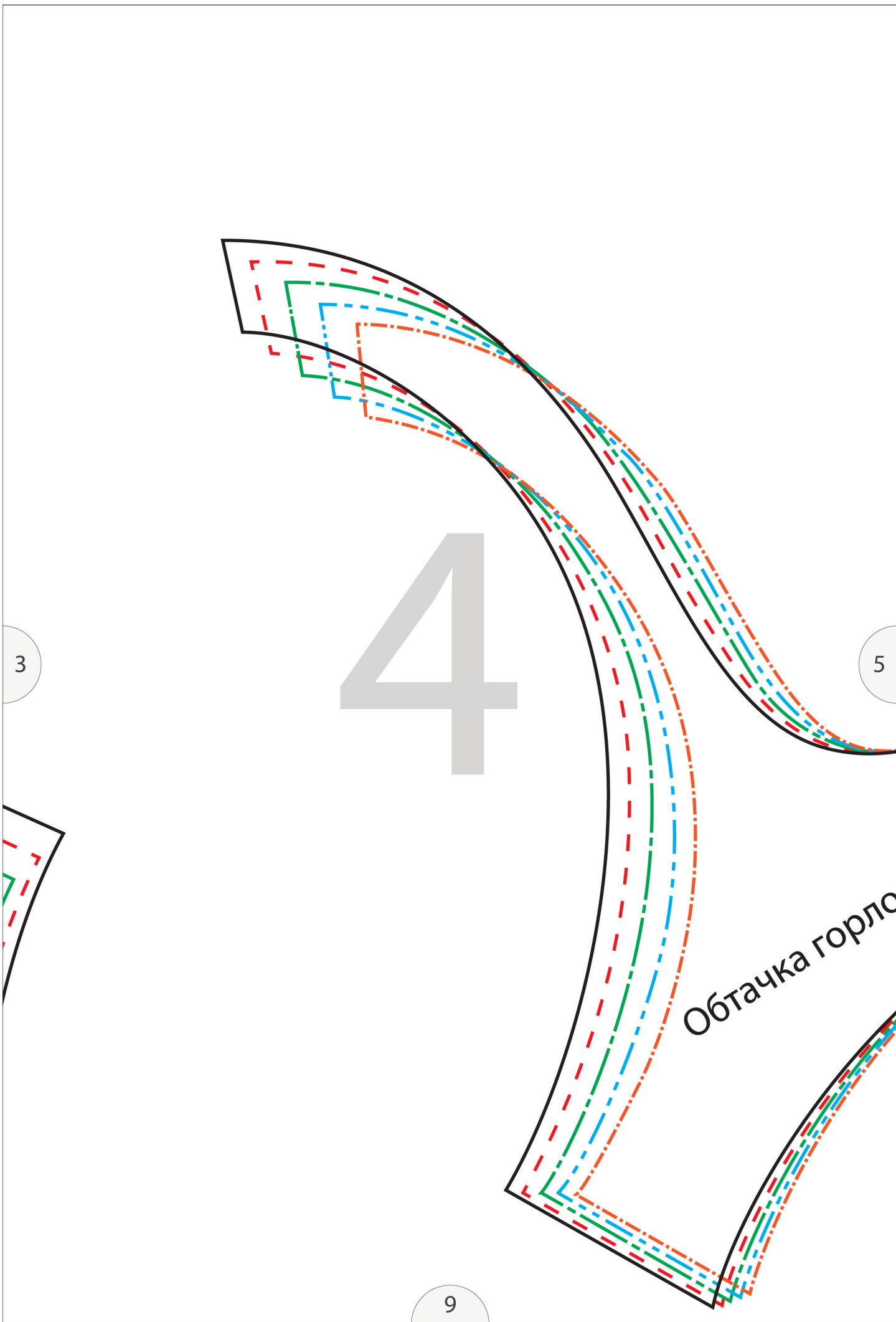

3

5

4

Обтачка горло

9

4

винны и проймы переда
1 деталь

Сгиб Долевая

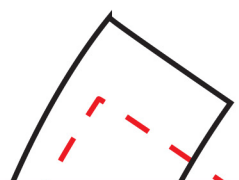
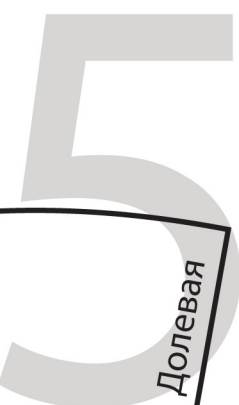

1

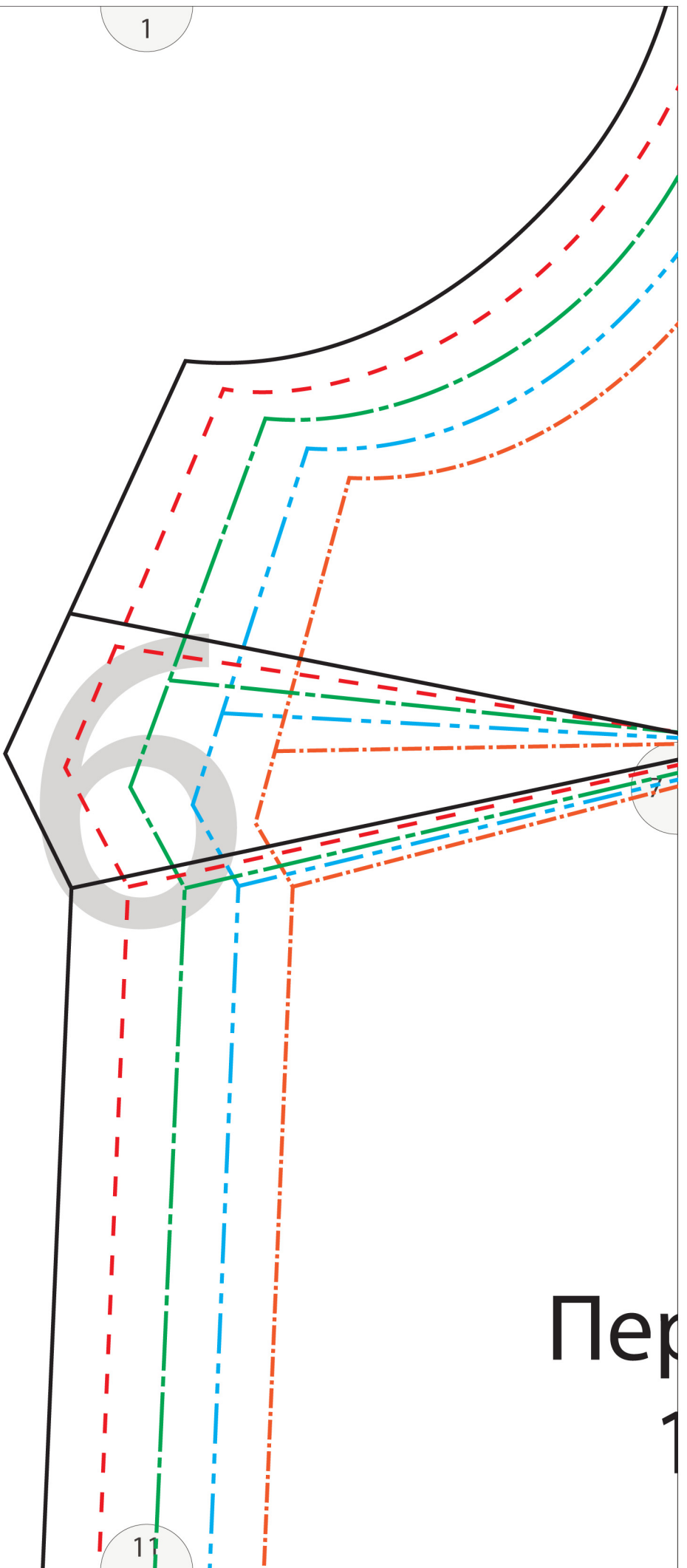

11

Пер
1

ред платья
деталь

7

Сгиб Долевая

3

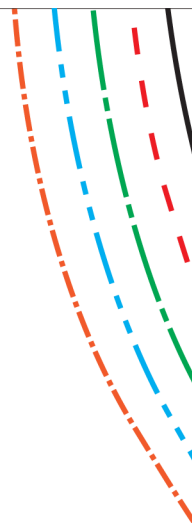

Сгиб
Долговая

8

7

9

Спинка платья
1 деталь

13

4

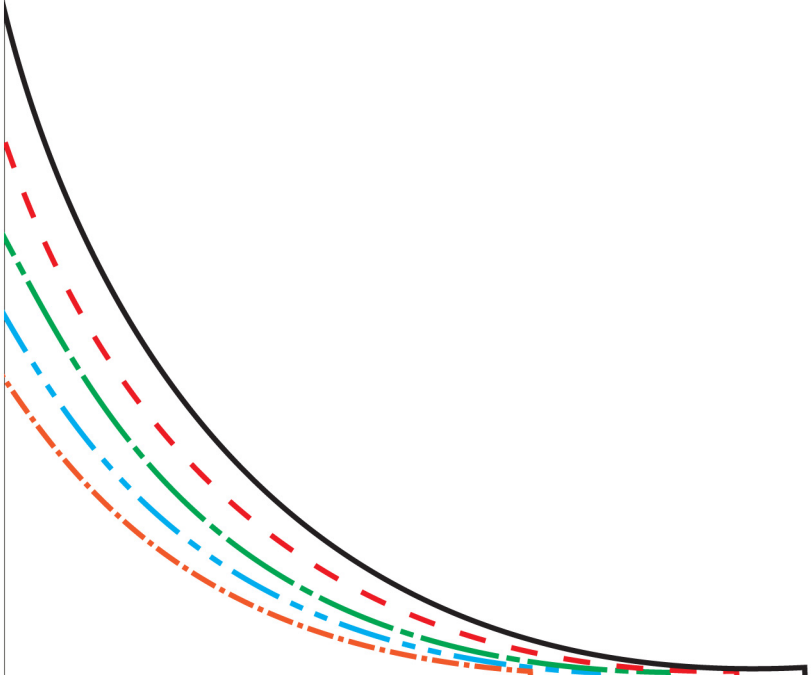

8

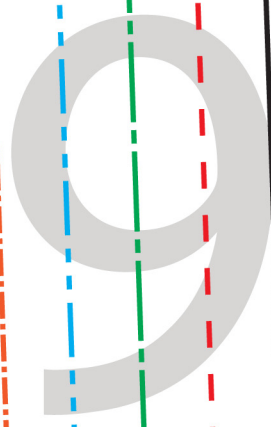

10

4

5

9

10

Линейка горловины и проймы спинки
1 деталь

15

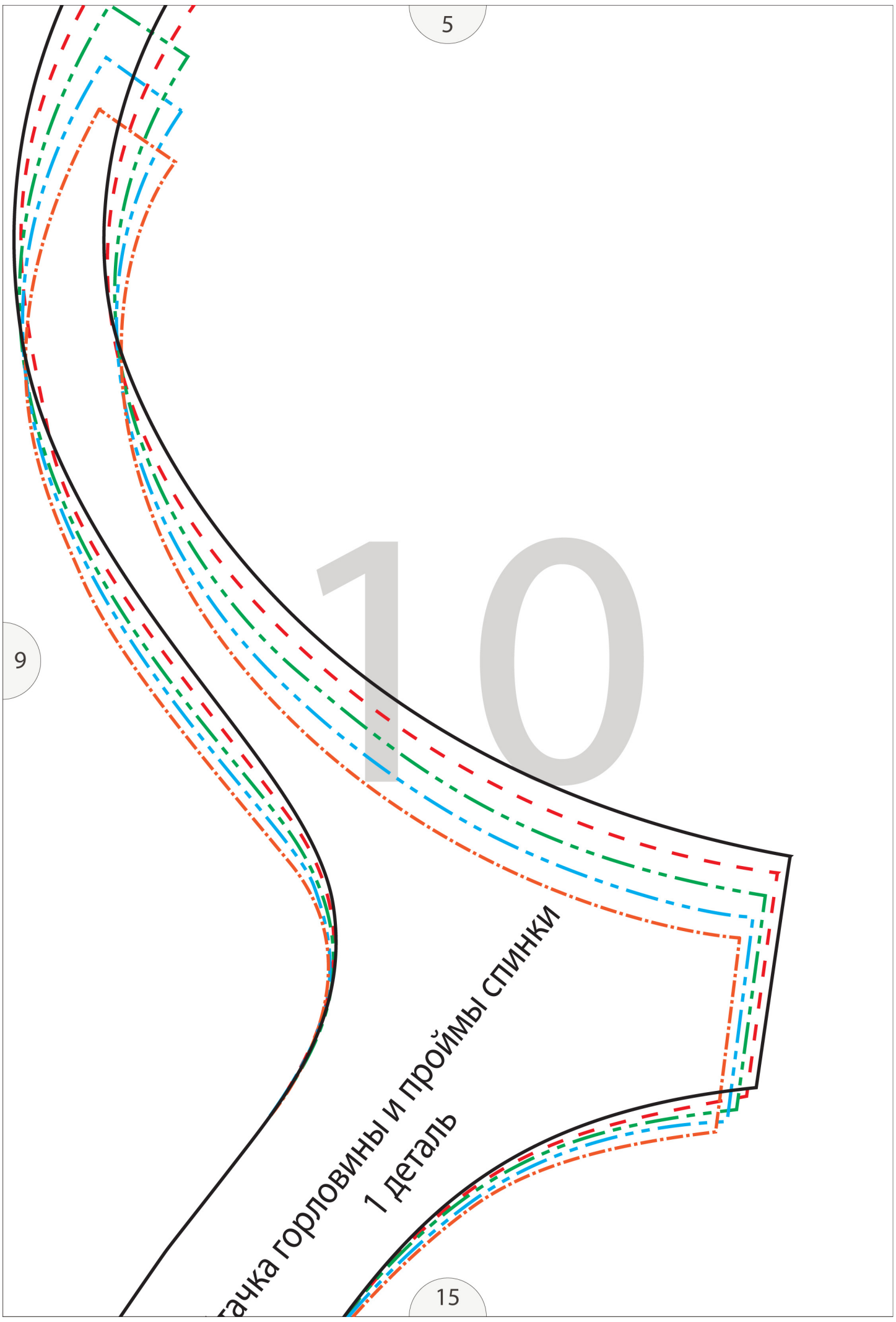

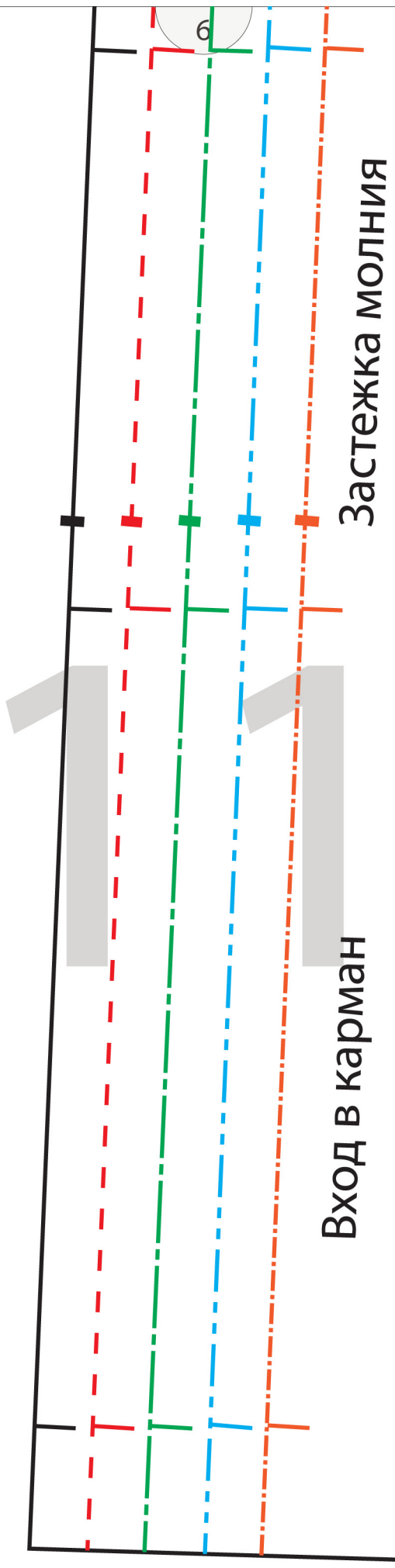

7

Талия

11

12

13

17

Талия

8

12

14

13

18

Вход в карман

Застежка молния

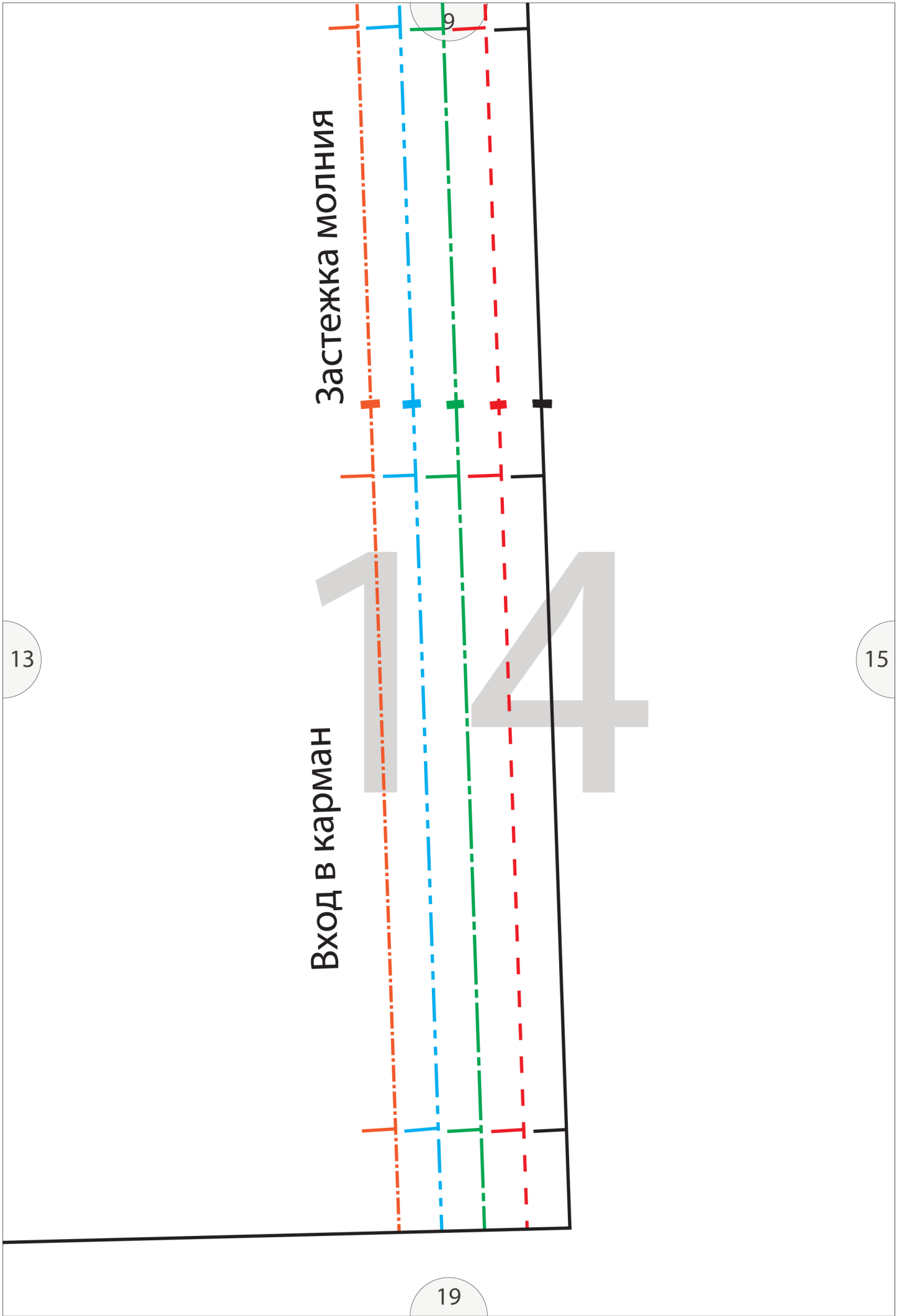

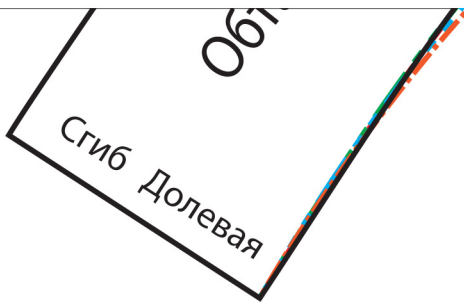

10

14



Долевая

20

Нижняя ча

16

сть переда платья
деталь

17

Нижняя часть спин 1 деталь

18

Сгиб
Долевая

шки платья

19