

# Angled Dress

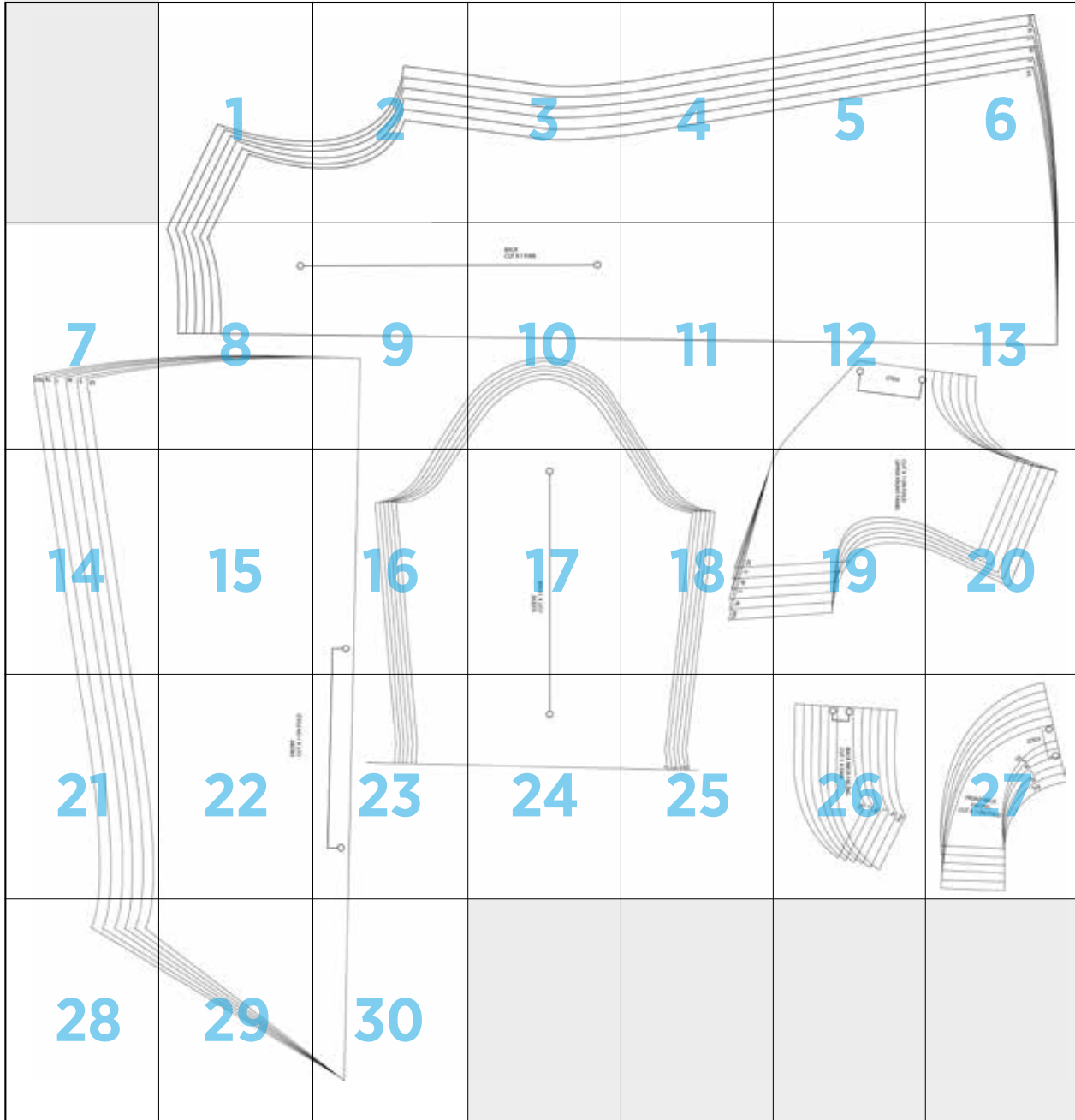

1

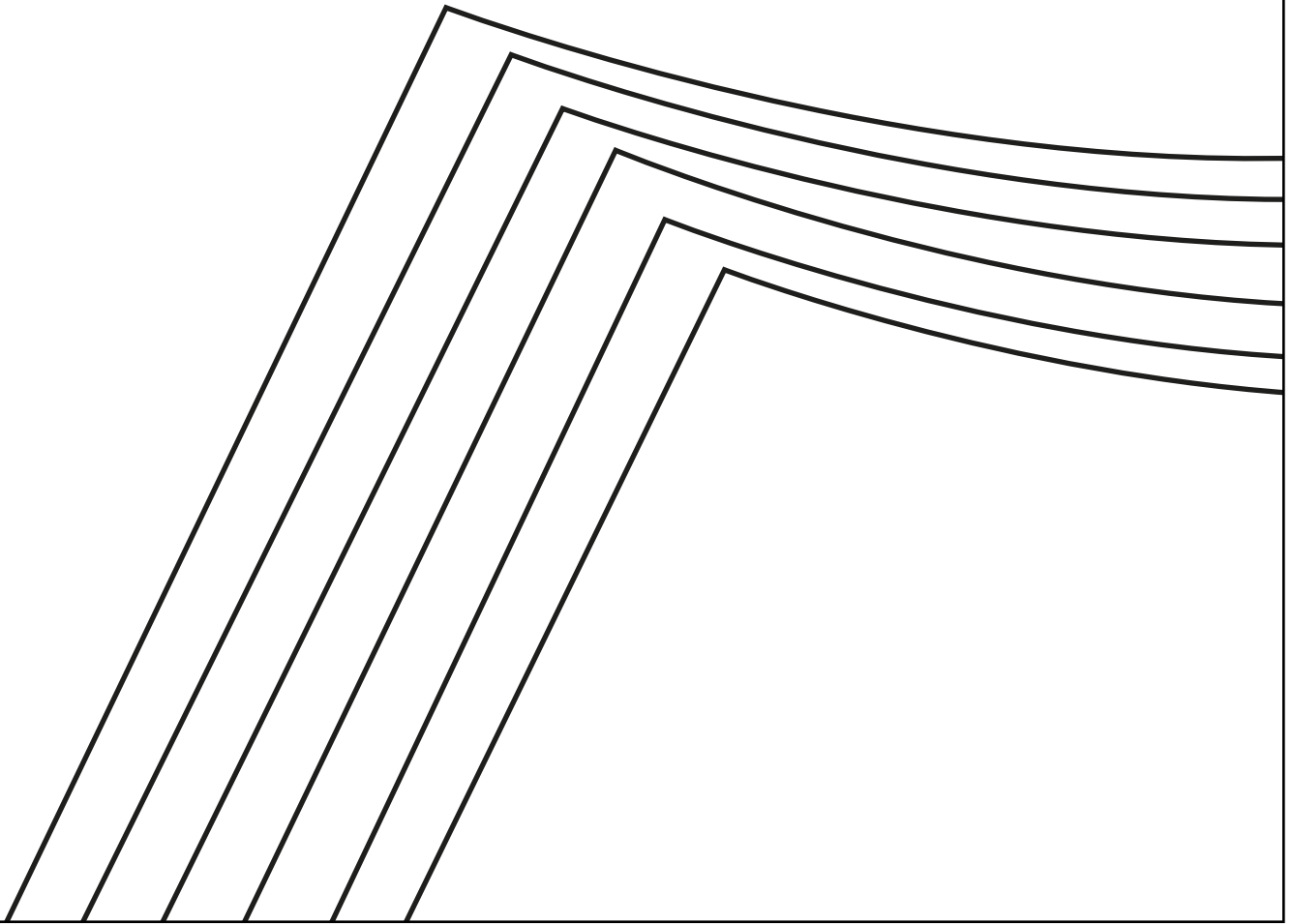

2

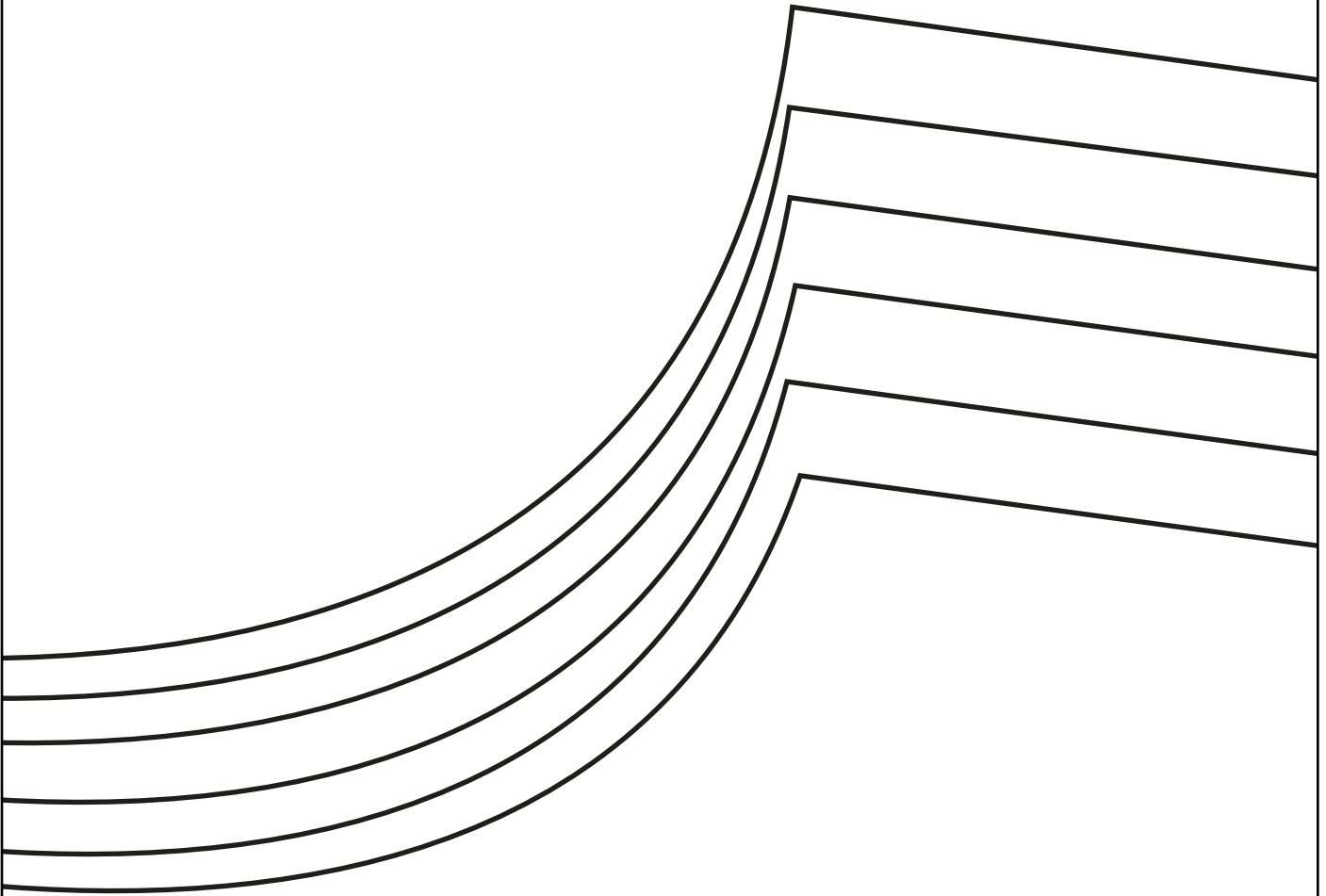

3

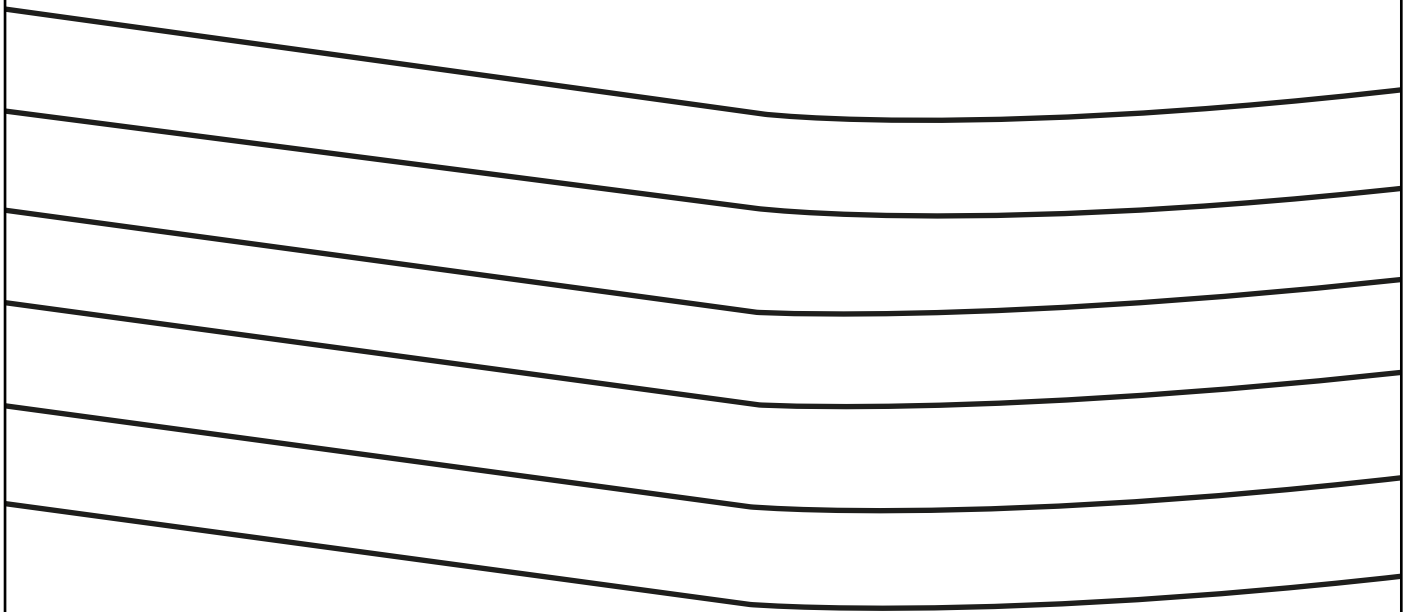

4

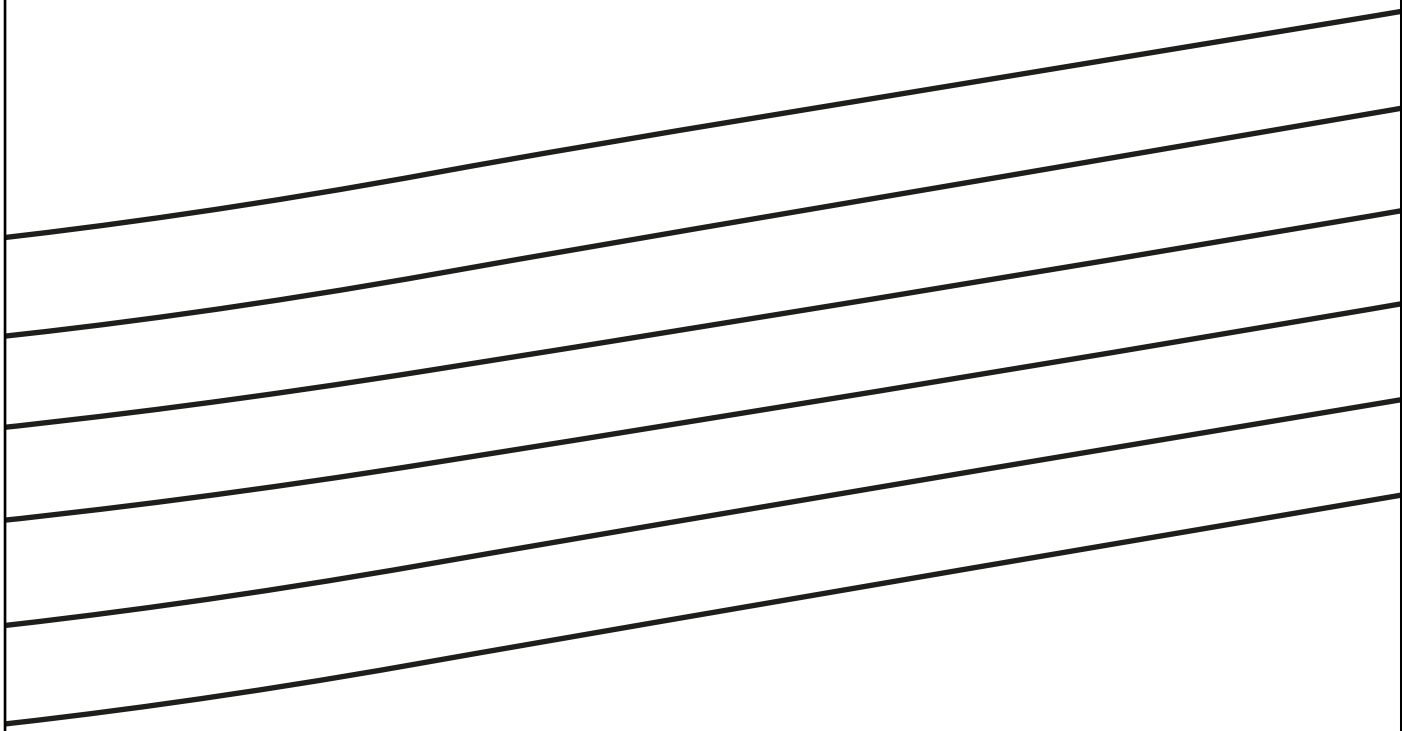

5

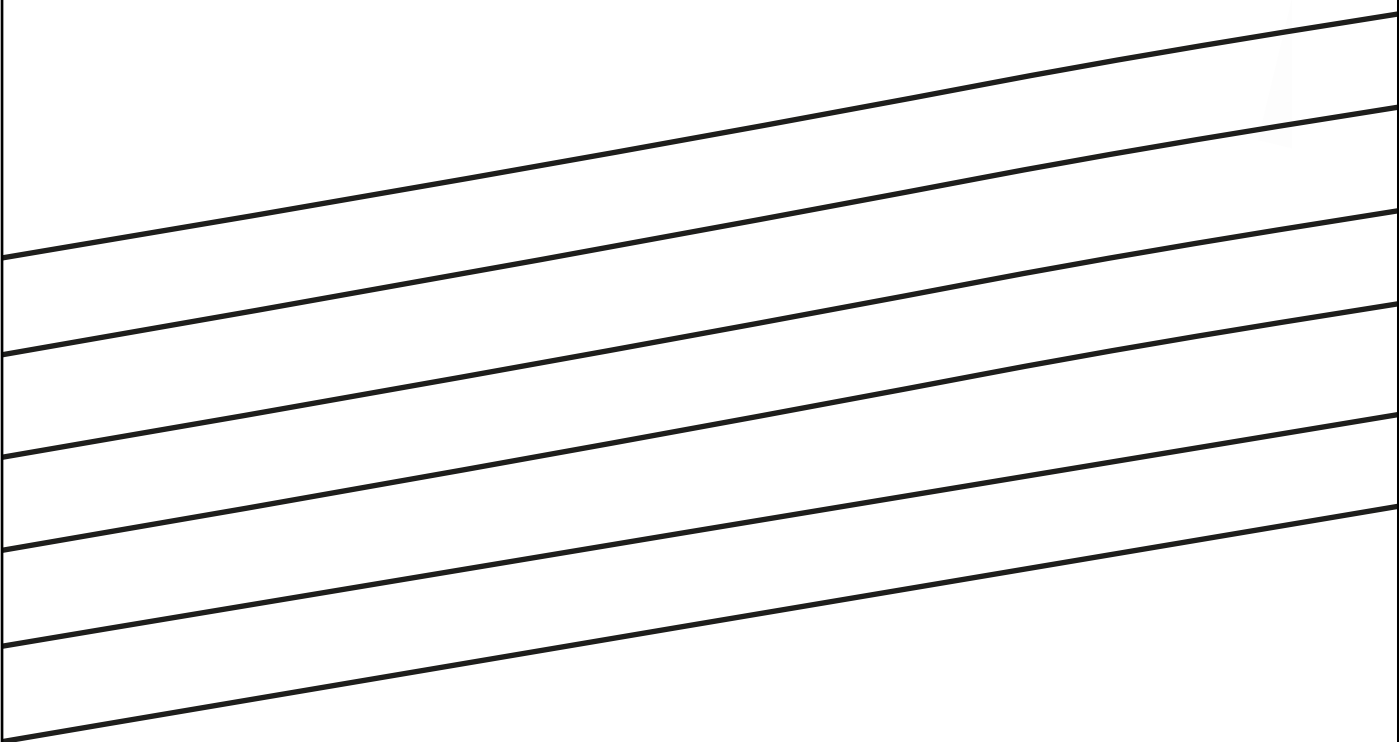

6

XXL  
XL  
L  
M  
S  
XS



7

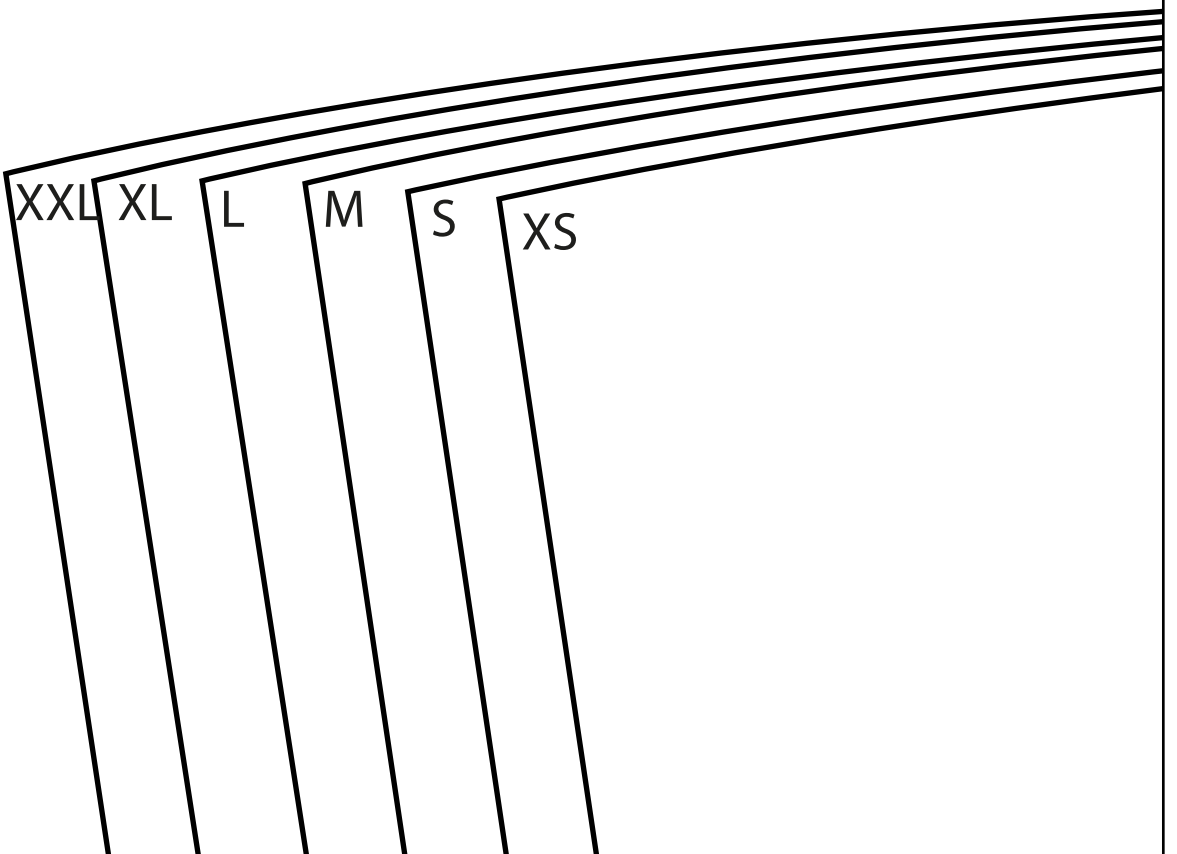



8

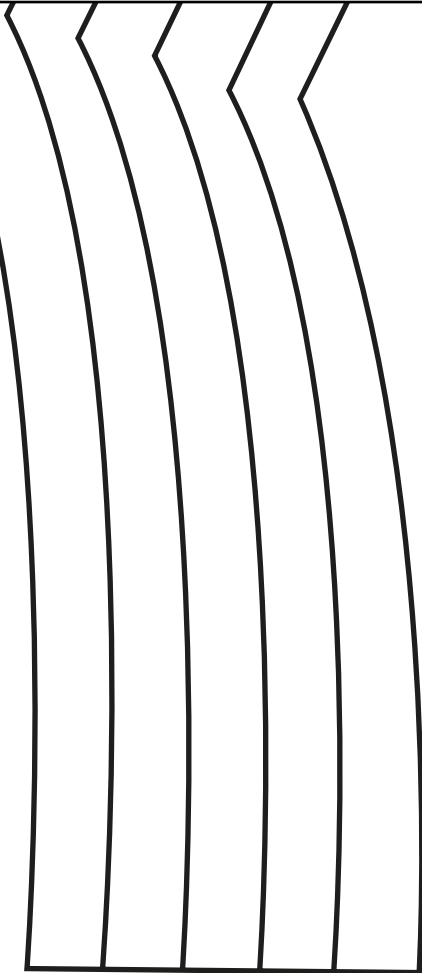

9

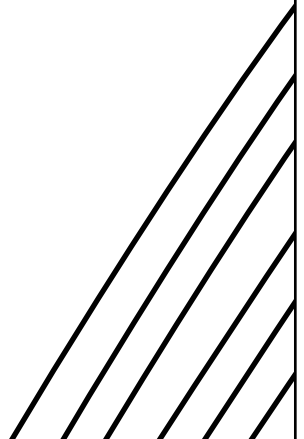
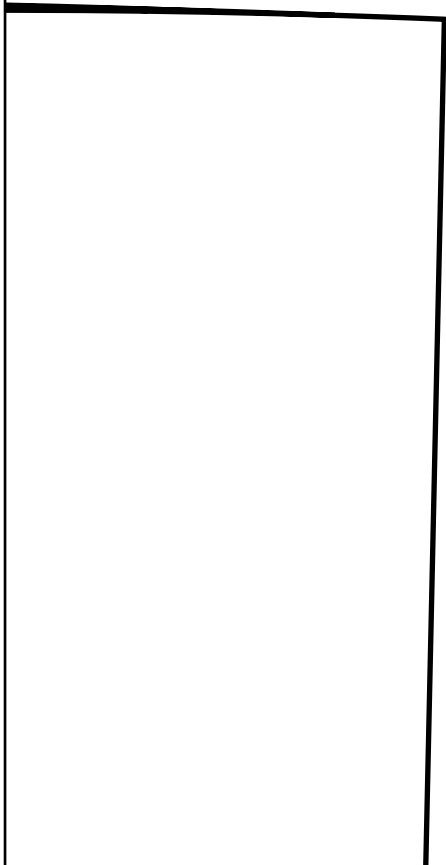

10

BACK  
CUT X 1 PAIR

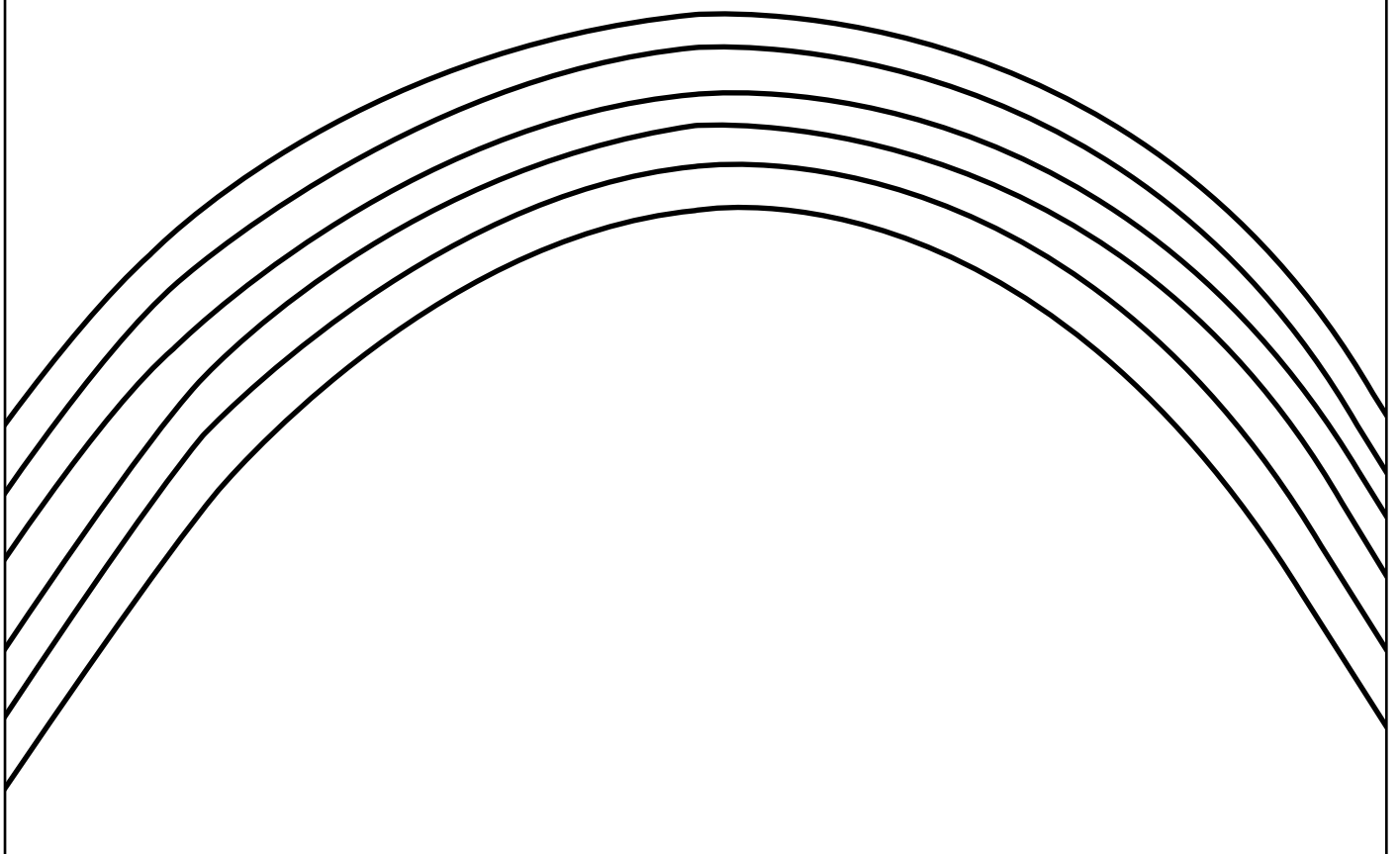

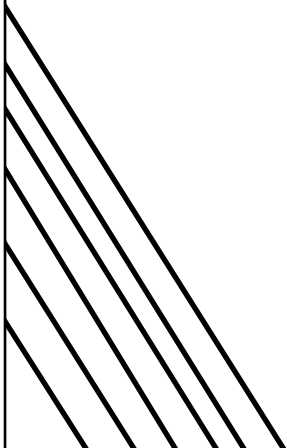

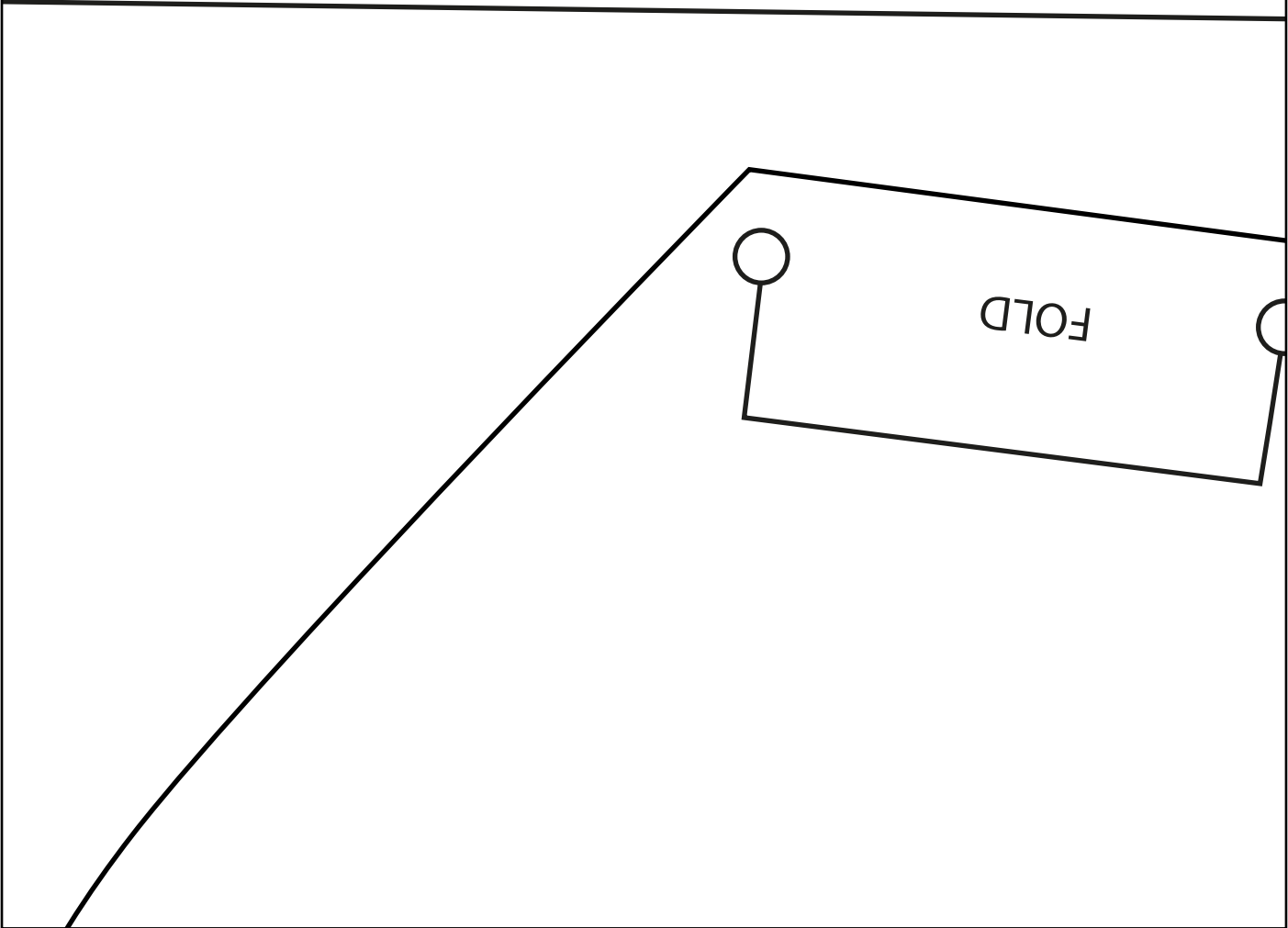

13

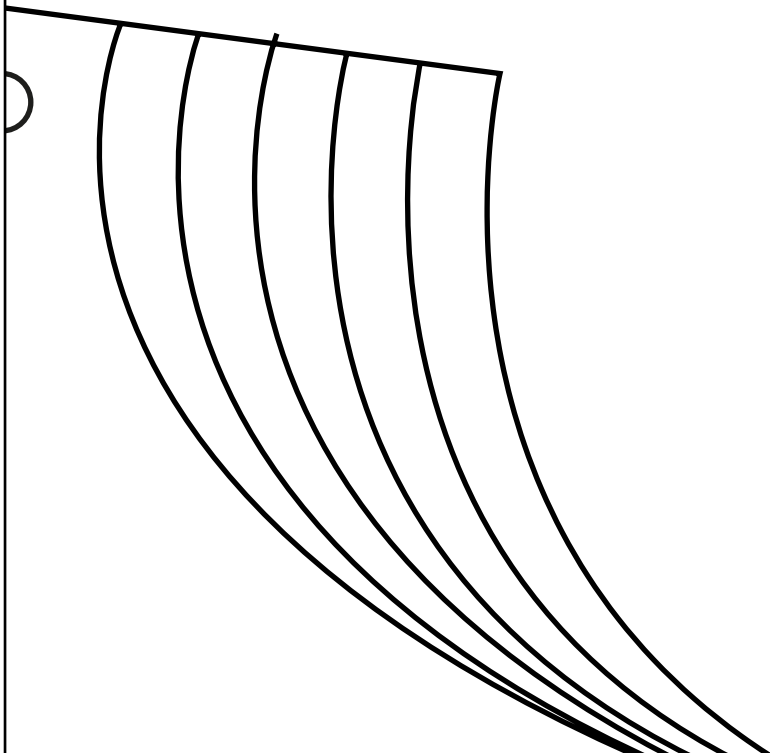

14







16

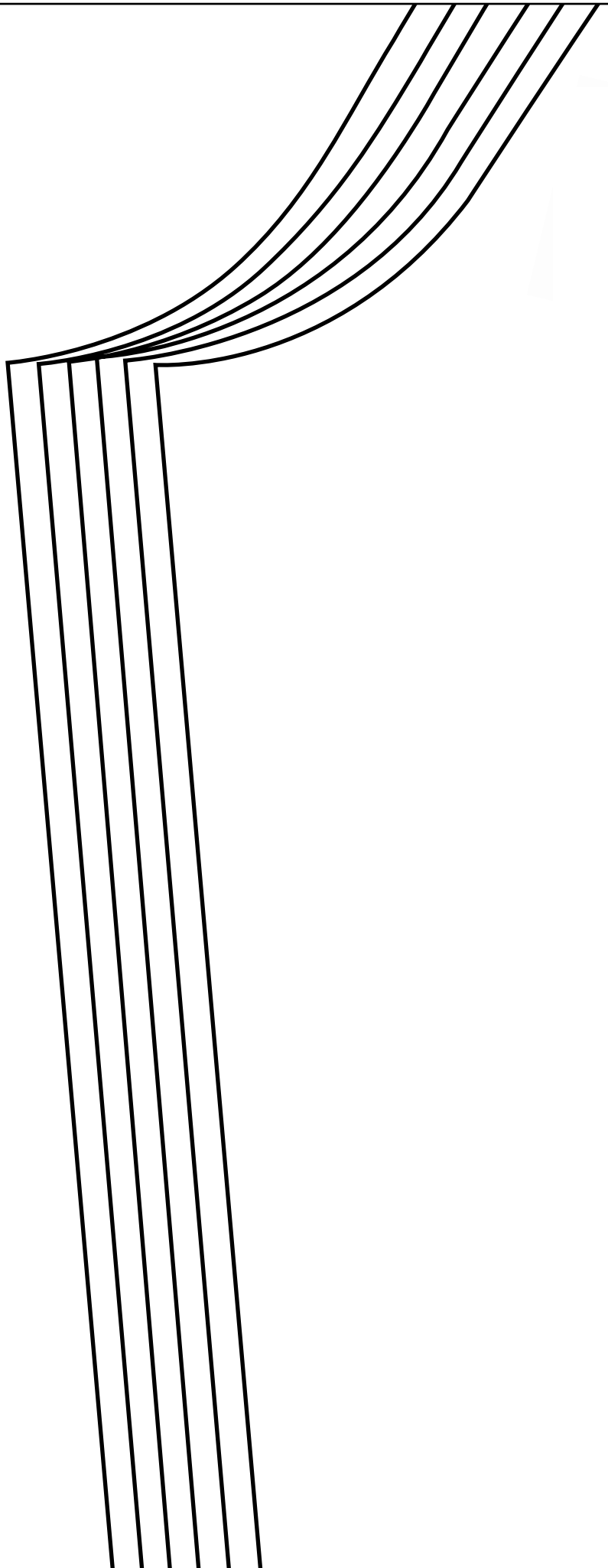
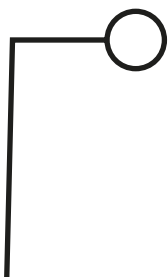

17

SLEEVE  
CUT X 1 PAIR



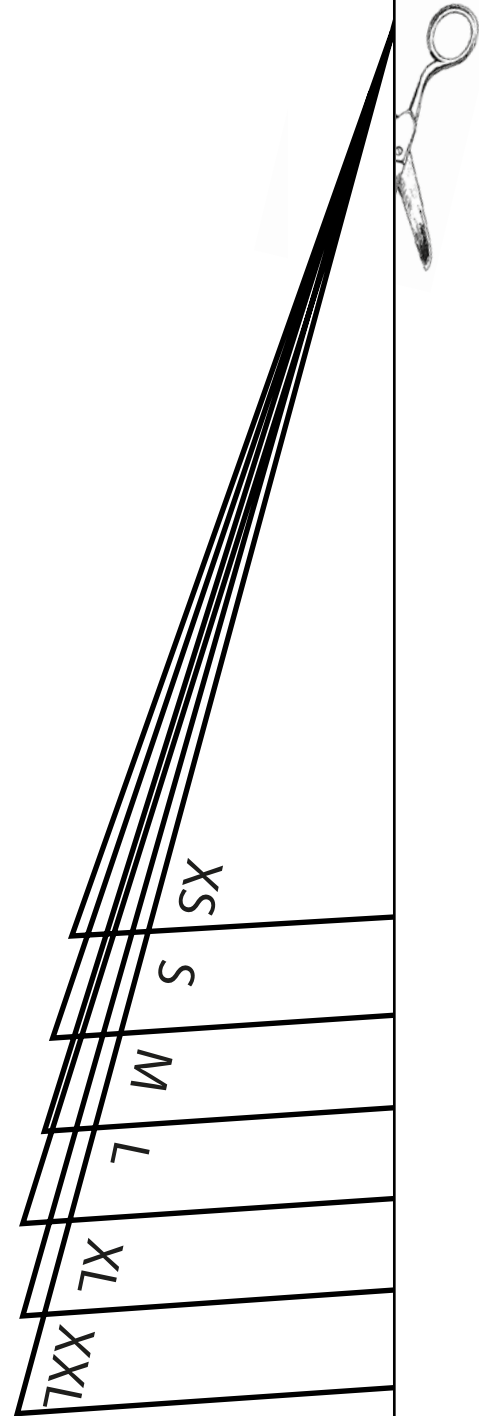

CUT X 1 ON FOLD  
UPPER FRONT PANEL

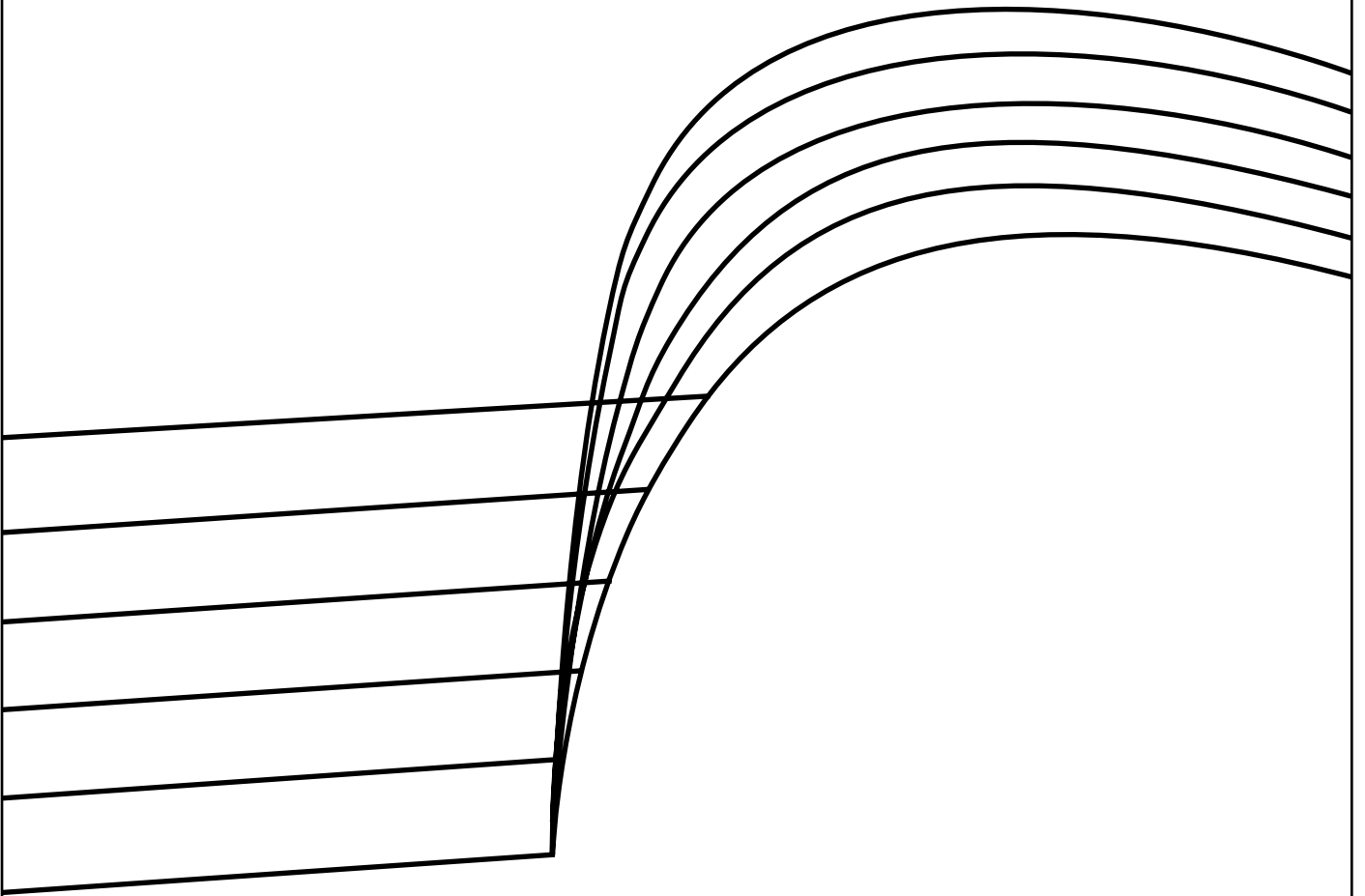

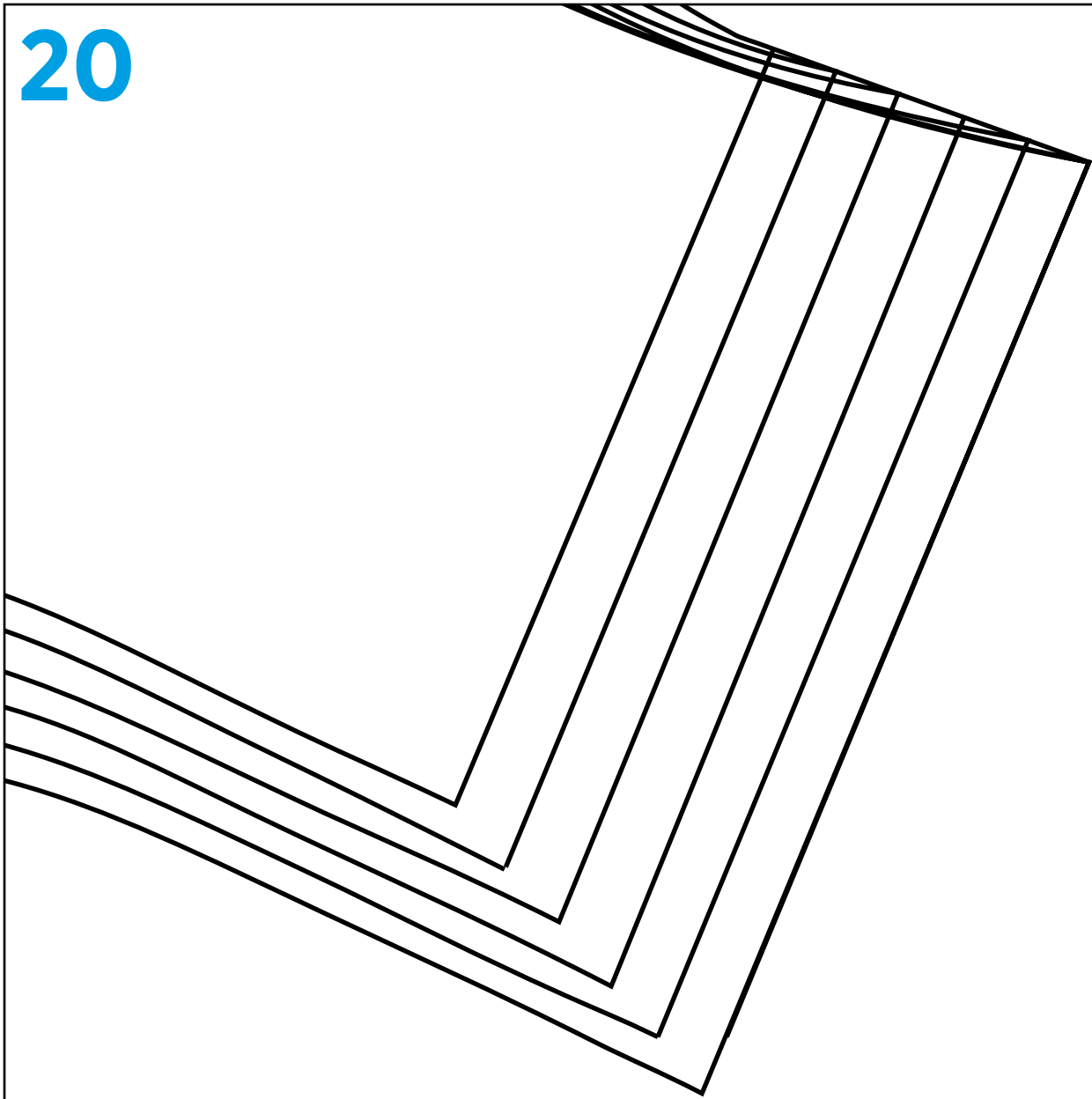

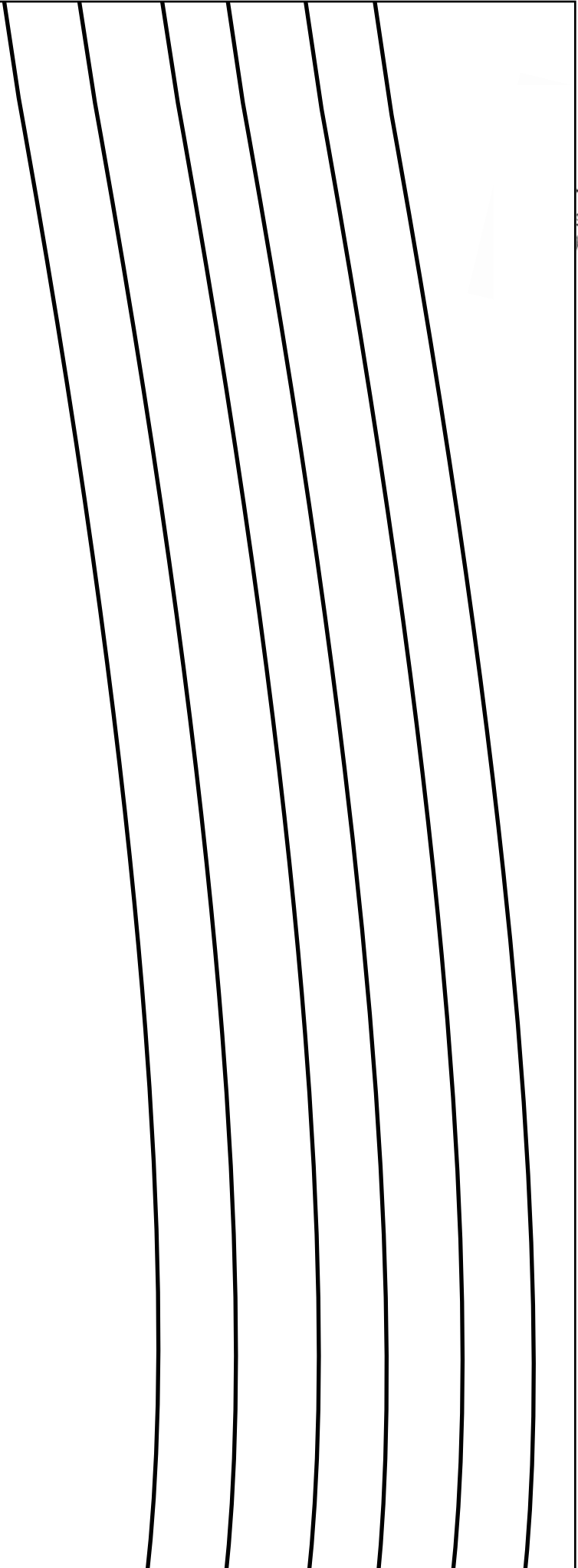

22

FRONT  
CUT X 1 ON FOLD



23

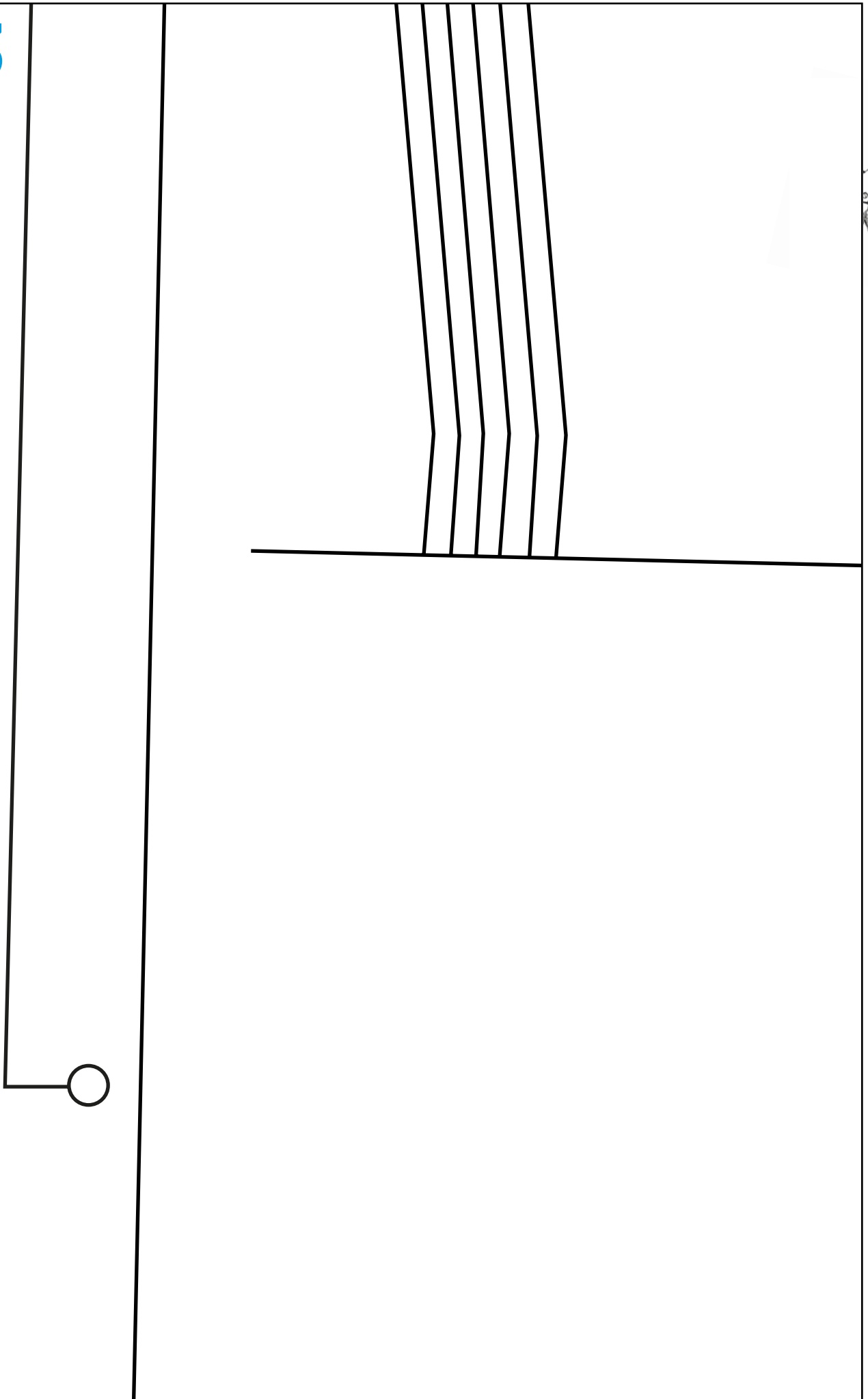





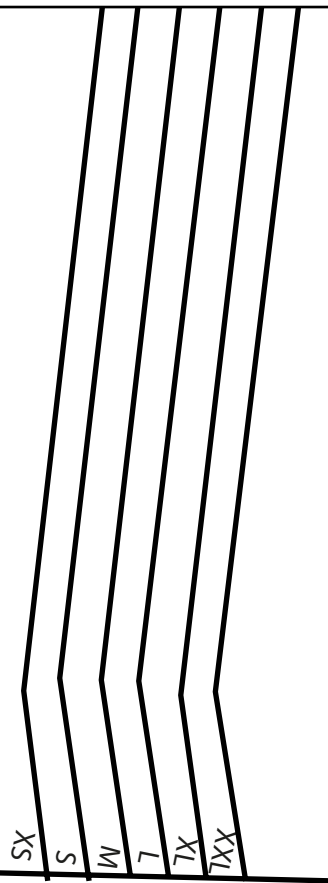

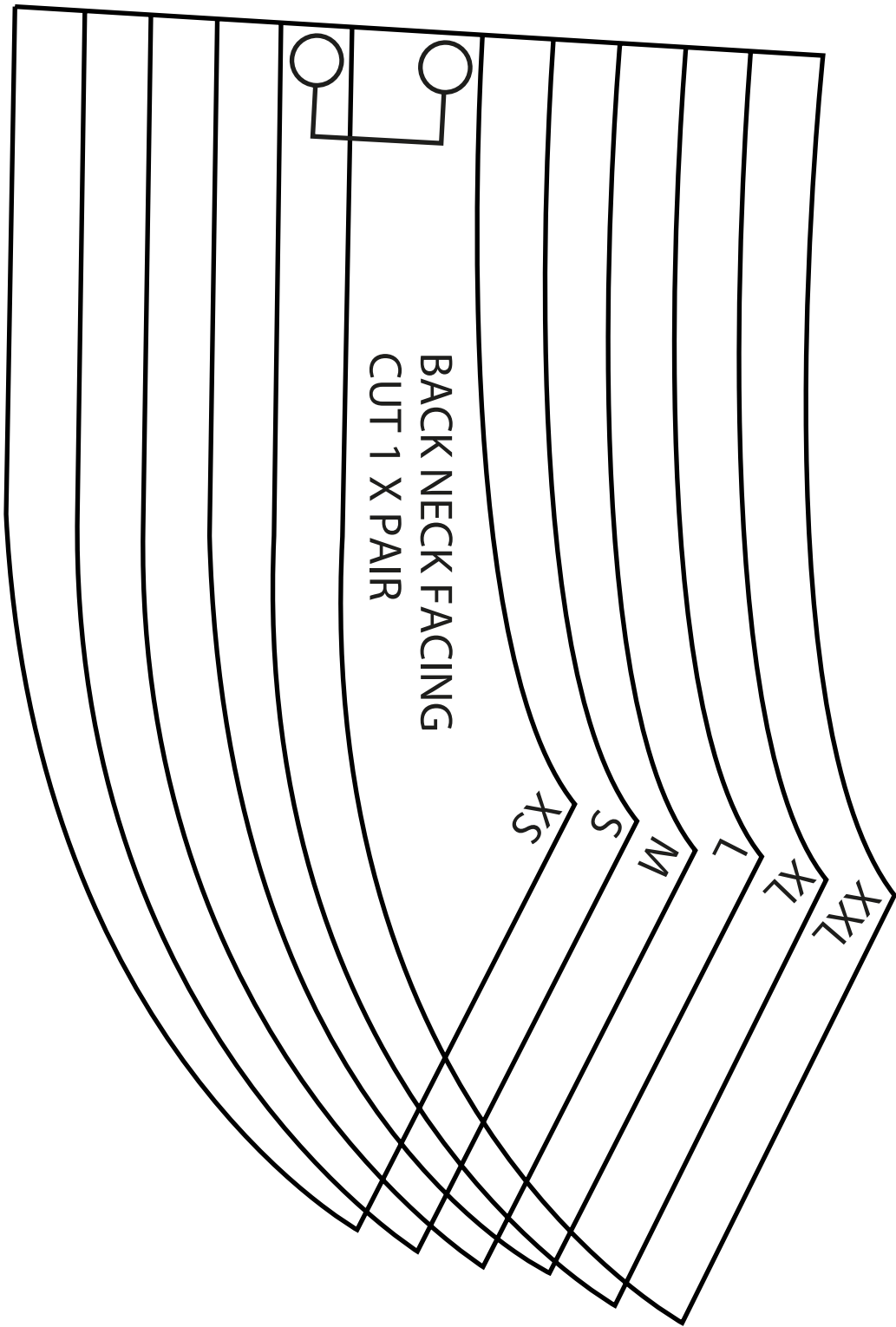

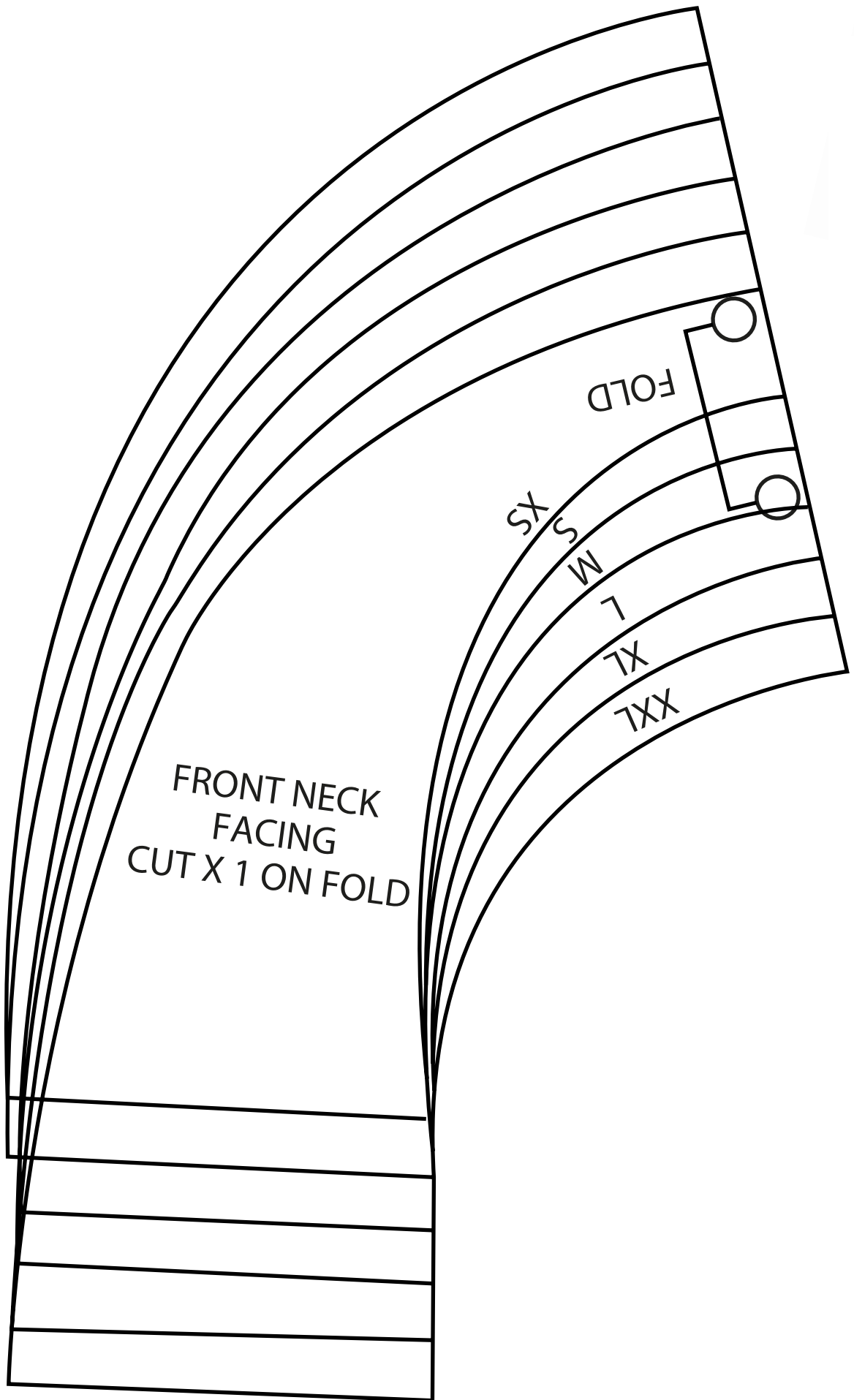

FRONT NECK  
FACING  
CUT X 1 ON FOLD

XS  
S  
M  
L  
XL  
XXL

FOLD

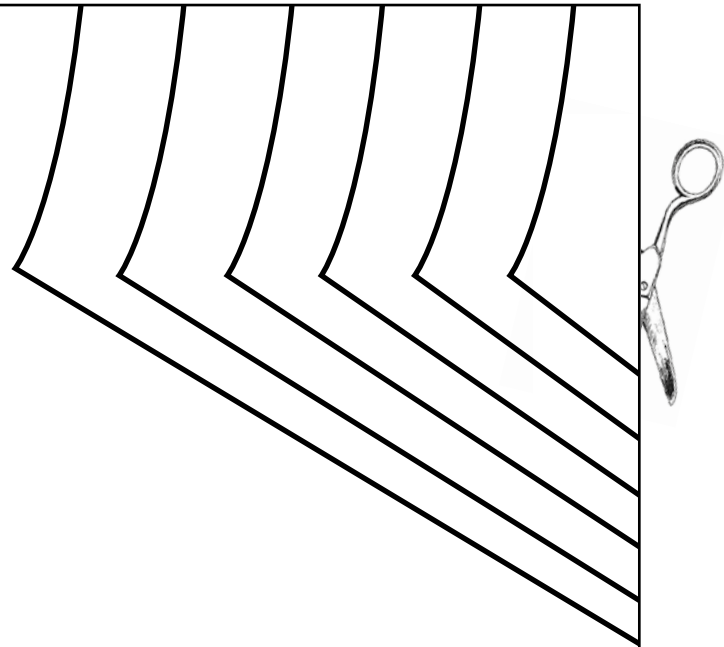

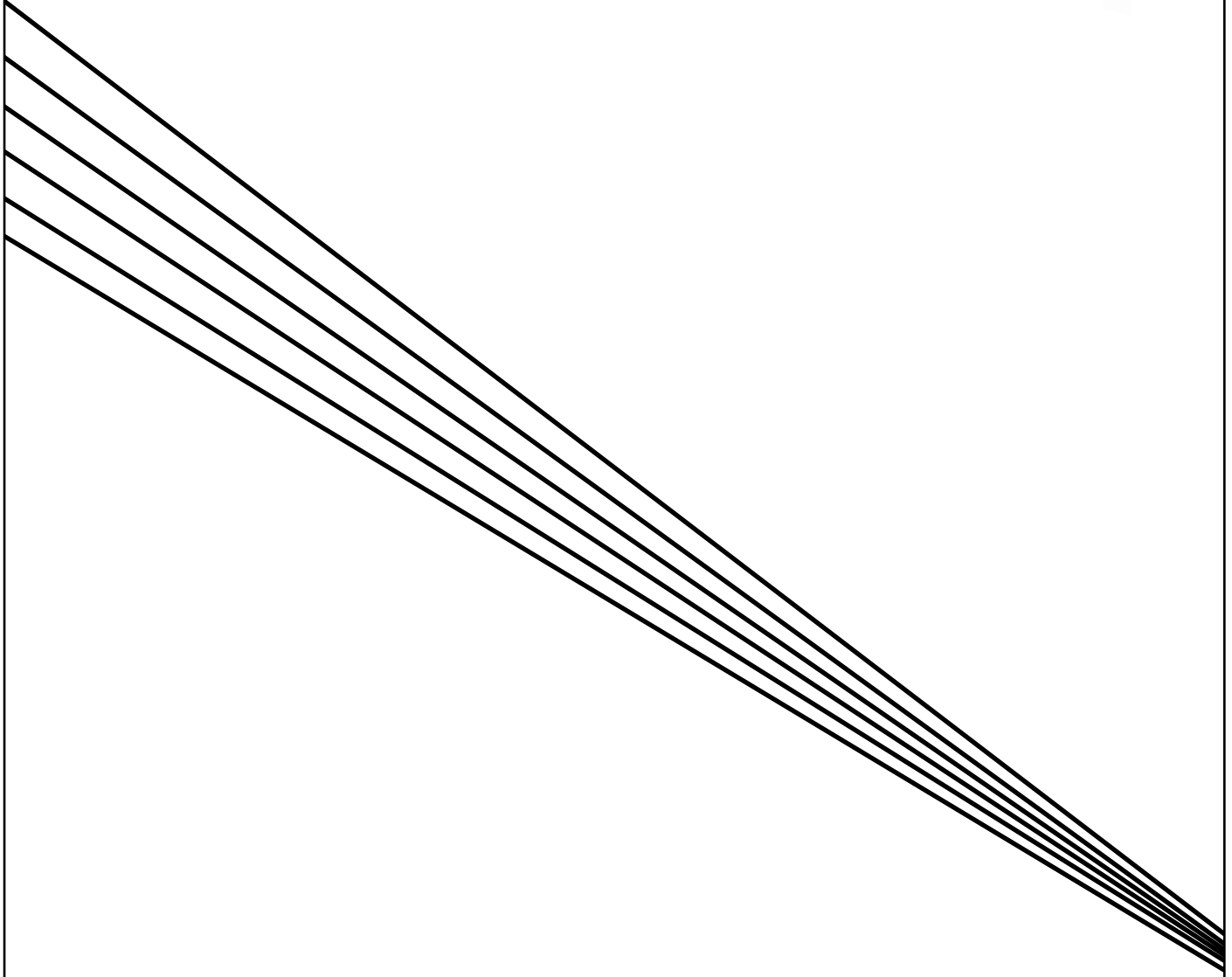

30

